



In association with  
Architecture Building Culture



TECHNICAL MEMORANDUM No.2 FINAL

## INVENTORY OF EXISTING CONDITIONS

Seattle-Tacoma International Airport

Prepared for  
Port of Seattle  
Seattle, Washington

March 2015





In association with

Architecture Building Culture

TECHNICAL MEMORANDUM No.2 FINAL

## **INVENTORY OF EXISTING CONDITIONS**

Seattle-Tacoma International Airport

Prepared for  
Port of Seattle  
Seattle, Washington

March 2015

TABLE OF CONTENTS

	Page		Page
Introduction.....	1-1	Air Cargo .....	5-1
1.1 Airport Master Plan Study Area.....	1-1	5.1 Introduction .....	5-1
Airfield .....	2-1	5.1.1 Cargo Warehouses.....	5-1
2.1 Runways .....	2-1	5.1.2 Cargo Hardstands .....	5-2
2.2 Taxiways.....	2-1	General Aviation .....	6-1
2.3 Non-Conforming Airfield Conditions.....	2-1	6.1 Introduction.....	6-1
2.4 Airfield Operations.....	2-1	Airline and Airport Support.....	7-1
2.4.1 Weather Occurrence.....	2-1	7.1 Airline Support .....	7-1
2.4.2 Runway Use Patterns .....	2-1	7.1.1 Airline Hangars .....	7-1
2.4.3 Pavement Conditions .....	2-1	7.1.2 Flight Kitchens .....	7-1
Passenger Terminal.....	3-1	7.1.3 Ground Service Equipment.....	7-1
3.1 Introduction .....	3-1	7.1.4 Aircraft Fuel Storage and Distribution.....	7-1
3.1.1 Aircraft Parking .....	3-1	7.2 Airport Support.....	7-2
3.1.2 Functional Space Allocation .....	3-1	7.2.1 Aircraft Rescue and Firefighting.....	7-2
3.1.3 Airline Ticketing.....	3-3	7.2.2 Ground Run-up Enclosure.....	7-2
3.1.4 Passenger Security .....	3-3	7.2.3 Airport Maintenance .....	7-2
3.1.5 Concessions .....	3-3	7.2.4 Airport Utilities Infrastructure.....	7-2
3.1.6 Concourse and Satellite Holdrooms.....	3-3	7.2.4.1 Electrical System .....	7-2
3.1.7 Baggage Systems .....	3-3	7.2.4.2 Industrial Waste System .....	7-2
Ground Transportation.....	4-1	7.2.4.3 Mechanical Systems .....	7-2
4.1 Introduction .....	4-1	7.2.4.4 Sanitary Sewer .....	7-3
4.1.1 Terminal Access.....	4-1	7.2.4.5 Storm Water Drainage .....	7-3
4.1.2 Transit Routes Serving Seattle-Tacoma International Airport.....	4-1	7.2.4.6 Vertical Conveyance.....	7-3
4.1.3 Terminal Area Roadways Traffic Operations.....	4-1	7.2.4.7 Water System.....	7-3
4.1.4 Parking .....	4-1	7.2.4.8 Natural Gas System.....	7-3
4.1.4.1 On-Airport Parking Facilities .....	4-1	7.2.4.9 Storm Water Drainage Basins.....	7-3
4.1.4.2 Employee Parking.....	4-2	7.2.4.10 Waste and Recycling Facilities.....	7-3
4.1.4.3 Off-Airport Parking.....	4-2		
4.1.5 Commercial Ground Transportation Services .....	4-2	Appendix A—Airfield Pavement Management Program	
4.1.5.1 Courtesy Vehicles.....	4-2		
4.1.5.2 Taxicabs, Limousines, and Shared-ride Vans .....	4-2		
4.1.5.3 Scheduled and Charter Services.....	4-2		
4.1.5.4 Ground Transportation Support Areas .....	4-2		
4.1.6 Consolidated Rental-Car Facility .....	4-2		
4.1.7 Bus Maintenance Facility.....	4-2		

TABLES

	Page		Page		
2-1	Runway Data.....	2-3	5-1	Summary of Air Cargo Warehouse Tenants and Area.....	5-4
2-2	Taxiway Characteristics.....	2-4	6-1	General Aviation Summary.....	6-3
2-3	Modification to Standards.....	2-5	7-1	Flight Kitchen Summary .....	7-14
3-1	Airlines Serving the Airport .....	3-43	7-2	Fuel Storage Capacity Summary.....	7-14
3-2	On-Gate Parking for Maximum Aircraft Mix–Airline Assignments and Aircraft Parking Capabilities.....	3-44	7-3	Fuel Storage Supply System .....	7-15
3-3	Off-Gate Parking Available for Remain Overnight Aircraft .....	3-45	7-4	Fueling Delivery Summary – Jet-A Fuel.....	7-15
3-4	Terminal Space Summary – Main Terminal .....	3-46	7-5	Fueling Vehicle Inventory .....	7-16
3-5	Terminal Space Summary – South Satellite.....	3-47	7-6	ARFF Facility Summary.....	7-16
3-6	Terminal Space Summary – North Satellite.....	3-48	7-7	ARFF Vehicle Summary.....	7-17
3-7	Airline Ticketing and Bag Drop Summary.....	3-49	7-8	Planned Ground Run-Up Enclosure Siting Options .....	7-18
3-8	Airline Office Areas .....	3-51	7-9	Airport Maintenance Summary .....	7-18
3-9	Security Checkpoints.....	3-52	7-10	Snow Removal Equipment.....	7-19
3-10	Concessionaires.....	3-53	7-11	Utilities Summary.....	7-20
3-11	Holdroom Summary .....	3-54			
3-12	Outbound Baggage Screening Systems Summary.....	3-55			
3-13	Inbound Baggage Carousel System Summary .....	3-56			
4-1	Transit Routes Serving the Airport.....	4-7			
4-2	Airport Owned Public Parking.....	4-8			
4-3	Employee Parking Summary.....	4-9			
4-4	Off-Airport Parking Capacity .....	4-10			
4-5	Monthly Courtesy Vehicle Trips 2013 – Parking, Hotels, Downtowners .....	4-11			
4-6	Monthly Door to Door Services Trips 2013 – Taxis, Limousines, Shuttles.....	4-11			
4-7	Scheduled Airporter Routes.....	4-12			
4-8	Rental Car Facility Summary.....	4-13			
4-9	Quick Turnaround Area Detail.....	4-14			
4-10	Bus Operations Summary.....	4-15			

## FIGURES

	Page		Page
1-1 Port of Seattle (Port) Aviation Properties .....	1-2	3-26 Overall Terminal Functional Allocation – Mezzanine Level .....	3-26
1-2 Airport Land Uses .....	1-3	3-27 Overall Terminal Functional Allocation – Mezzanine Level Area 1 .....	3-27
1-3 On-Airport Facilities – Southeast .....	1-4	3-28 Overall Terminal Functional Allocation – Mezzanine Level Area 2 .....	3-28
1-4 On-Airport Facilities – Southwest .....	1-5	3-29 Overall Terminal Functional Allocation – Mezzanine Level Area 3 .....	3-29
1-5 On-Airport Facilities – Northeast .....	1-6	3-30 Overall Terminal Functional Allocation – Mezzanine Level Area 4 .....	3-30
1-6 On-Airport Facilities – Northwest .....	1-7	3-31 Overall Terminal Functional Allocation – Third & Fourth Levels .....	3-31
1-7 FAA Critical Zone for Wildlife Management .....	1-8	3-32 Overall Terminal Functional Allocation – Office Building .....	3-32
2-1 Airfield/Taxiway Designations .....	2-1	3-33 South Satellite Functional Allocation – STS, FIS and Ramp Levels .....	3-33
2-2 Primary Runway Use Configurations .....	2-2	3-34 South Satellite Functional Allocation – Secure Corridor Concourse & Penthouse Levels .....	3-34
3-1 Passenger Terminal Layout .....	3-1	3-35 North Satellite Functional Allocation – STS and Ramp Levels .....	3-35
3-2 Gate Locations and Aircraft Parking .....	3-2	3-36 North Satellite Functional Allocation – Concourse & Penthouse Levels .....	3-36
3-3 Off-Gate Parking at Ramp Areas (South) .....	3-3	3-37 Security Checkpoints (Concourse Level) .....	3-37
3-4 Off-Gate Parking at Ramp Areas (North) .....	3-4	3-38 Security Checkpoints Area 1 .....	3-38
3-5 Airport Terminal and Concourse Levels .....	3-5	3-39 Security Checkpoints Area 2 .....	3-39
3-6 Overall Terminal Functional Allocation – STS Level .....	3-6	3-40 Security Checkpoints Area 3 .....	3-40
3-7 Overall Terminal Functional Allocation – STS Level Area 1 .....	3-7	3-41 Security Checkpoints Area 4 .....	3-41
3-8 Overall Terminal Functional Allocation – STS Level Area 2 .....	3-8	3-42 Security Checkpoints Area 5 .....	3-42
3-9 Overall Terminal Functional Allocation – STS Level Area 3 .....	3-9	4-1 Vicinity Map and Public Transportation Routes .....	4-3
3-10 Overall Terminal Functional Allocation – STS Level Area 4 .....	3-10	4-2 On-Airport Roadway System .....	4-4
3-11 Overall Terminal Functional Allocation – Baggage Level .....	3-11	4-3 Curbside Ground Transportation (Garage Level 3) .....	4-5
3-12 Overall Terminal Functional Allocation – Baggage Level Area 1 .....	3-12	4-4 Airport-Related Parking Facilities .....	4-6
3-13 Overall Terminal Functional Allocation – Baggage Level Area 2 .....	3-13	5-1 Air Cargo Facilities .....	5-3
3-14 Overall Terminal Functional Allocation – Baggage Level Area 3 .....	3-14	6-1 General Aviation Area .....	6-2
3-15 Overall Terminal Functional Allocation – Baggage Level Area 4 .....	3-15	7-1 Airline Support Areas .....	7-4
3-16 Overall Terminal Functional Allocation – Bridge Level .....	3-16	7-2 Airport Support Areas .....	7-5
3-17 Overall Terminal Functional Allocation – Bridge Level Area 1 .....	3-17	7-3 Major Airport Utilities – Jet Fuel .....	7-6
3-18 Overall Terminal Functional Allocation – Bridge Level Area 2 .....	3-18	7-4 Major Airport Utilities – Electrical .....	7-7
3-19 Overall Terminal Functional Allocation – Bridge Level Area 3 .....	3-19	7-5 Major Airport Utilities – Industrial Waste System .....	7-8
3-20 Overall Terminal Functional Allocation – Bridge Level Area 4 .....	3-20	7-6 Major Airport Utilities – Sanitary Sewer .....	7-9
3-21 Overall Terminal Functional Allocation – Concourse Level .....	3-21	7-7 Major Airport Utilities – Stormwater Drainage .....	7-10
3-22 Overall Terminal Functional Allocation – Concourse Level Area 1 .....	3-22	7-8 Major Airport Utilities – Water .....	7-11
3-23 Overall Terminal Functional Allocation – Concourse Level Area 2 .....	3-23	7-9 Major Airport Utilities – Natural Gas .....	7-12
3-24 Overall Terminal Functional Allocation – Concourse Level Area 3 .....	3-24	7-10 Storm Water Drainage Basins .....	7-13
3-25 Overall Terminal Functional Allocation – Concourse Level Area 4 .....	3-25		

# Introduction

*This Technical Memorandum presents an inventory of existing conditions (Inventory) related to facilities and land uses at Seattle-Tacoma International Airport (the Airport, or SEA).*

This Technical Memorandum presents an inventory of existing conditions (Inventory) related to facilities and land uses at Seattle-Tacoma International Airport (the Airport, or SEA) and is organized into seven sections as follows:

1. Airport Master Plan Study Area
2. Airfield
3. Passenger Terminal
4. Ground Transportation
5. Air Cargo
6. General Aviation
7. Airline and Airport Support

The Inventory was designed as a high-level tabular and graphic reference document for use by the planning team. A study regarding the age and present condition of the facilities are currently being commissioned by the Port; that information will be provided in a separate report when available. Other documents related to the Sustainable Airport Master Plan (e.g., Technical Memorandum No. 4: Aviation Activity Forecasts and Technical Memorandum No. 5: Facility Requirements and Alternatives) contain extensive context-specific data. An inventory of baseline environmental conditions can be found in Technical Memorandum No. 7.

The information presented in this Inventory was compiled from documents provided by Port staff and includes information from reports prepared either by the Port or its consultants. The facilities are described as they existed in 2014. Targeted updates to the Airfield section, specifically Table 2-1, Section 2.4.2 and Table 2-3, were made in 2017. Figure 4-1 was also updated in 2017 to include the extension of the Central Link light rail line south.

## 1.1 Airport Master Plan Study Area

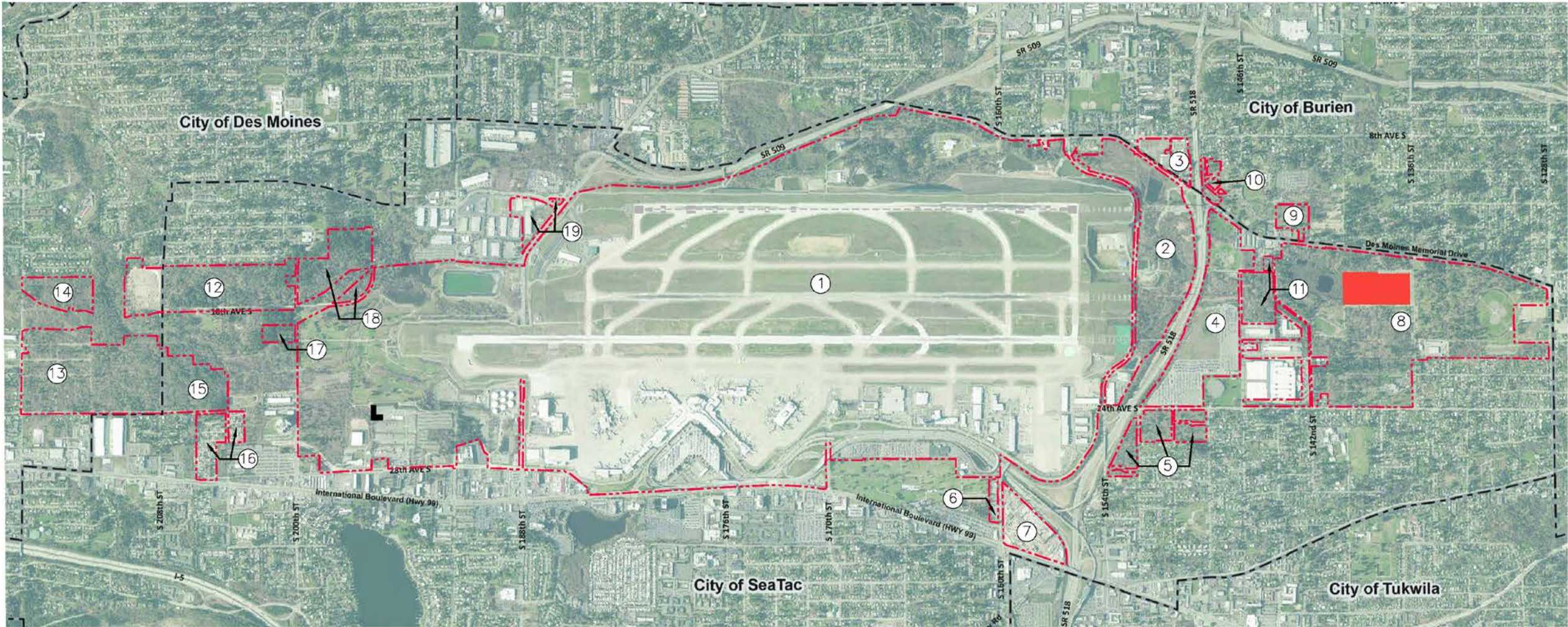
This section of the Inventory contains information related to airport property boundaries, facilities, land uses, and wildlife management.

The Airport occupies a total area of approximately 2,300 acres. The properties comprising the Airport are shown in Figure 1-1 and Airport land uses are shown in Figure 1-2.

Major facilities within the contiguous Airport boundary (i.e., “on-Airport”) are shown in Figures 1-3 through 1-6.

The FAA critical zone for wildlife management is shown in Figure 1-7

Figure 1-1  
**Port of Seattle (Port) Aviation Properties**  
 Seattle-Tacoma International Airport



LEGEND

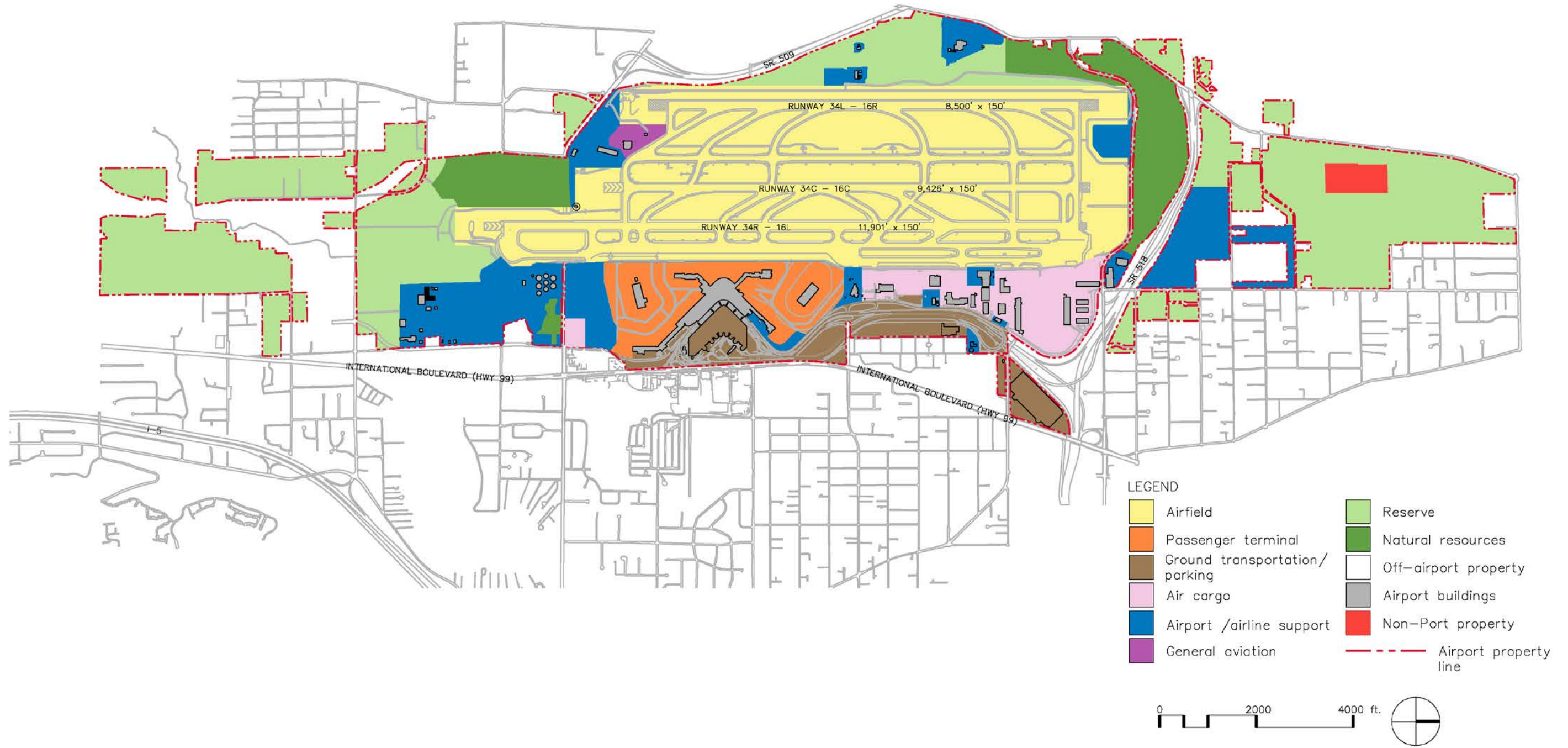
- |  |  |
|--|--|
| 1. Seattle-Tacoma International Airport                  | 11. 13-Acre Parcel                                 |
| 2. Northwest Ponds Environmental Mitigation Site         | 12. South 200th Development Area                   |
| 3. North East Redevelopment Area (NERA) (Lora Lake Site) | 13. Des Moines Creek Business Park (DMCBP) Phase 1 |
| 4. North Employee Parking Lot (NEPL) Site                | 14. DMCBP Phase 2                                  |
| 5. North End Cargo Parcels                               | 15. DMCBP Phase 3                                  |
| 6. South 160th Street GT Site                            | 16. South 5-Acre 509 Parcel                        |
| 7. Rental Car Facility Site                              | 17. South 5-Acre Parcel                            |
| 8. North End Cargo 55 Acre Site                          | 18. Unnamed parcel                                 |
| 9. NERA 3  | 19. 34L Runway Protection Zone (RPZ)               |
| 10. NERA 2   |  |

- Non-Port property
- Airport property line
- City boundaries

0 2000 4000 ft.

Source: Port Airport Property Book 2014

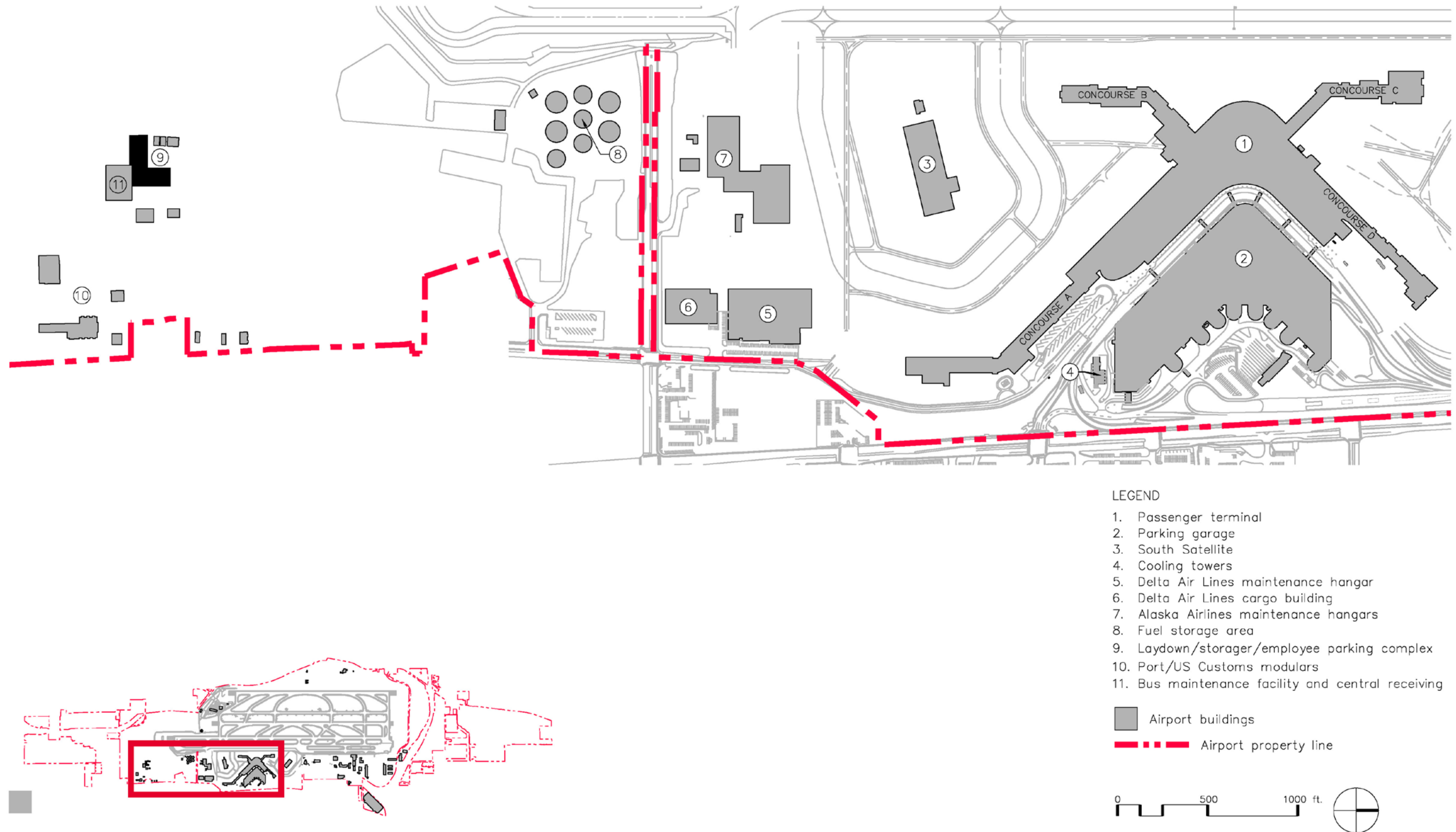
Figure 1-2  
**Airport Land Uses**  
 Seattle-Tacoma International Airport



Source: Port Airport Property Book 2014



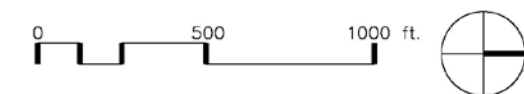
Figure 1-3  
**On-Airport Facilities – Southeast**  
 Seattle-Tacoma International Airport



LEGEND

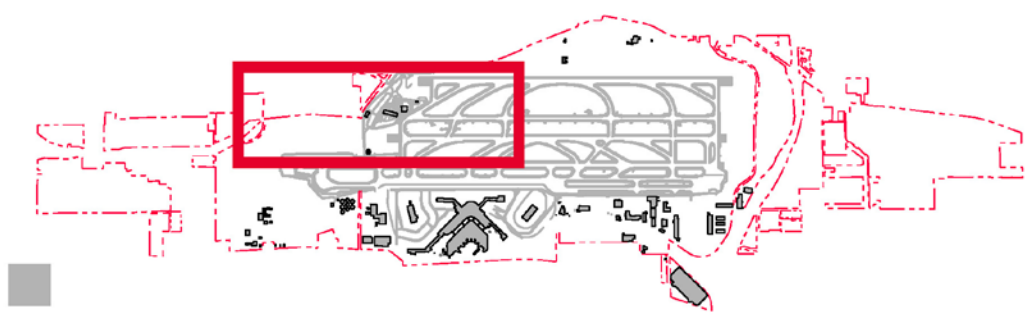
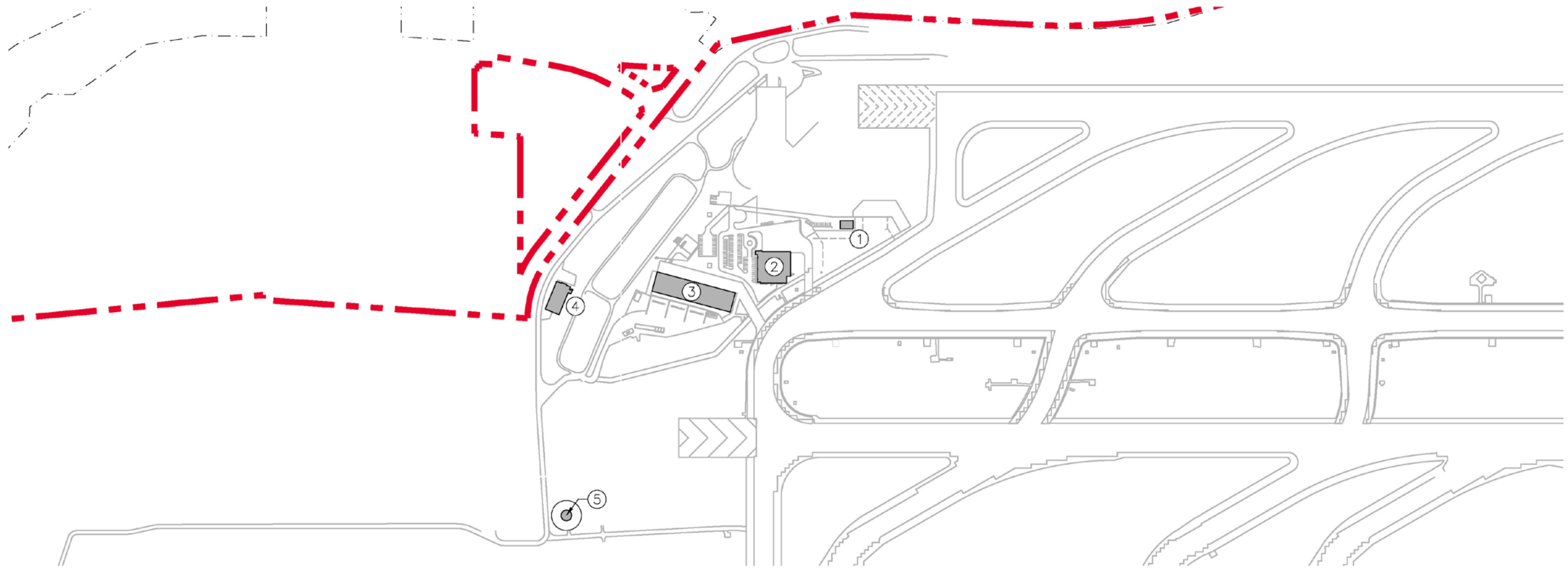
- 1. Passenger terminal
- 2. Parking garage
- 3. South Satellite
- 4. Cooling towers
- 5. Delta Air Lines maintenance hangar
- 6. Delta Air Lines cargo building
- 7. Alaska Airlines maintenance hangars
- 8. Fuel storage area
- 9. Laydown/storage/employee parking complex
- 10. Port/US Customs modulars
- 11. Bus maintenance facility and central receiving

- Airport buildings
- Airport property line





Source: Airport Layout Plan (December 2007)

Figure 1-4  
**On-Airport Facilities – Southwest**  
 Seattle-Tacoma International Airport



LEGEND

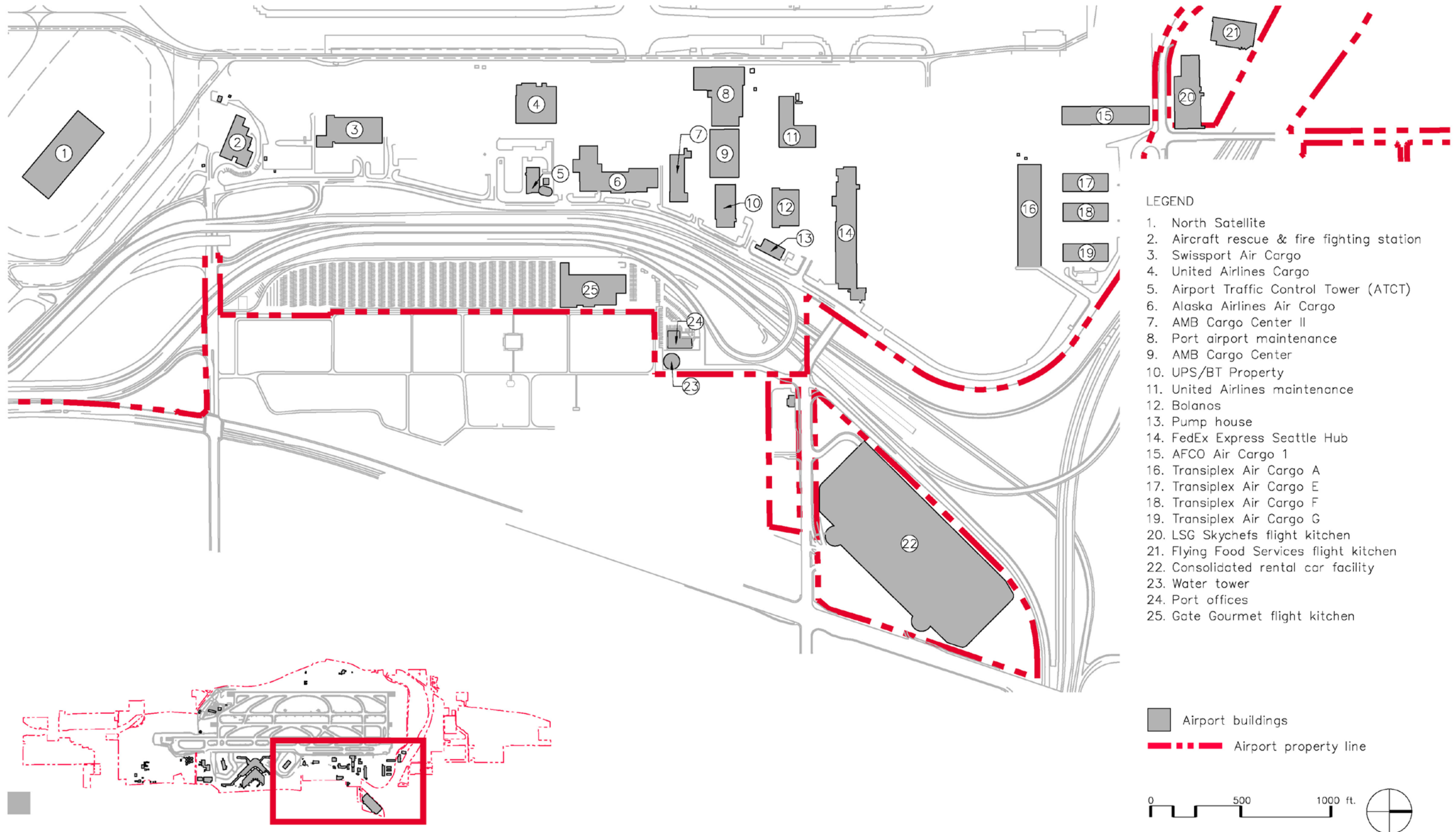
- 1. General aviation building
- 2. Weyerhaeuser corporate hangar
- 3. Snow equipment storage
- 4. Industrial waste treatment plant
- 5. VHF Omnidirectional Range/Tactical Aircraft Control (VORTAC)

-  Airport buildings
-  Airport property line



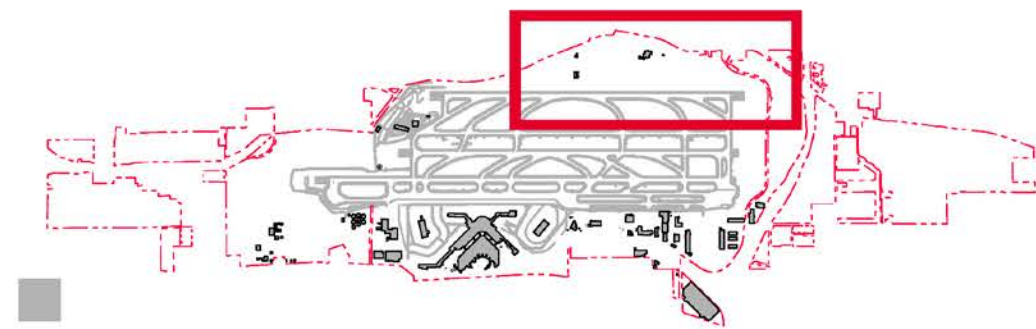
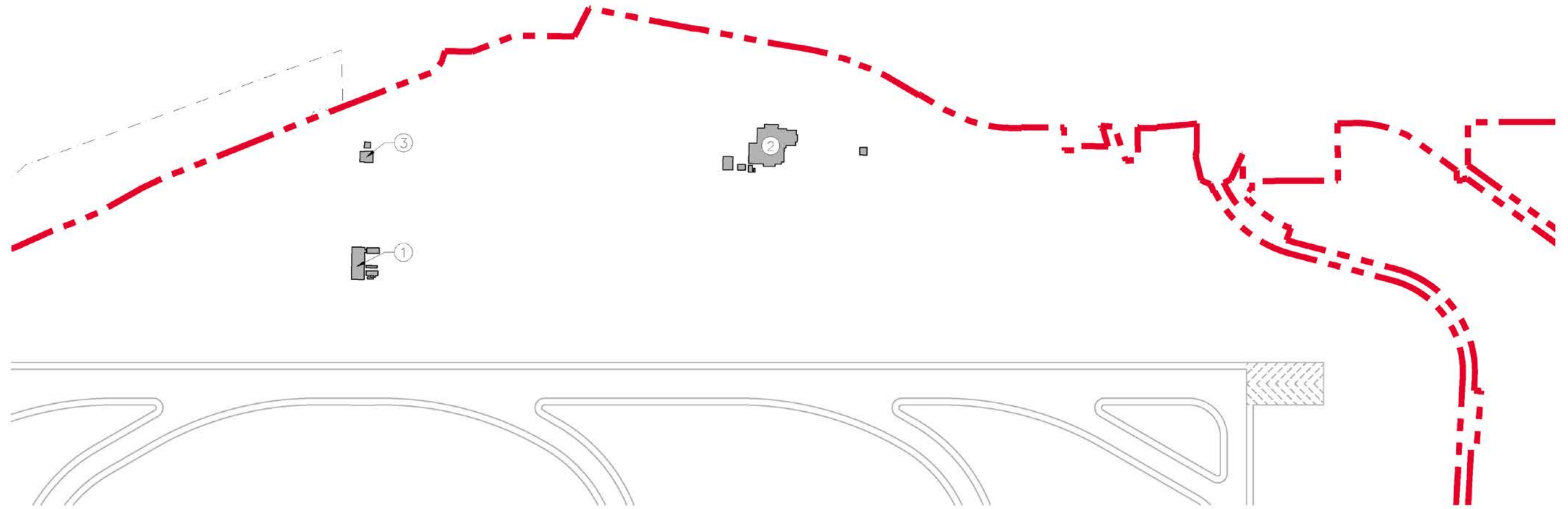
Source: Airport Layout Plan (December 2007)

Figure 1-5  
**On-Airport Facilities – Northeast**  
 Seattle-Tacoma International Airport



Source: Airport Layout Plan (December 2007)

Figure 1-6  
**On-Airport Facilities – Northwest**  
 Seattle-Tacoma International Airport



LEGEND

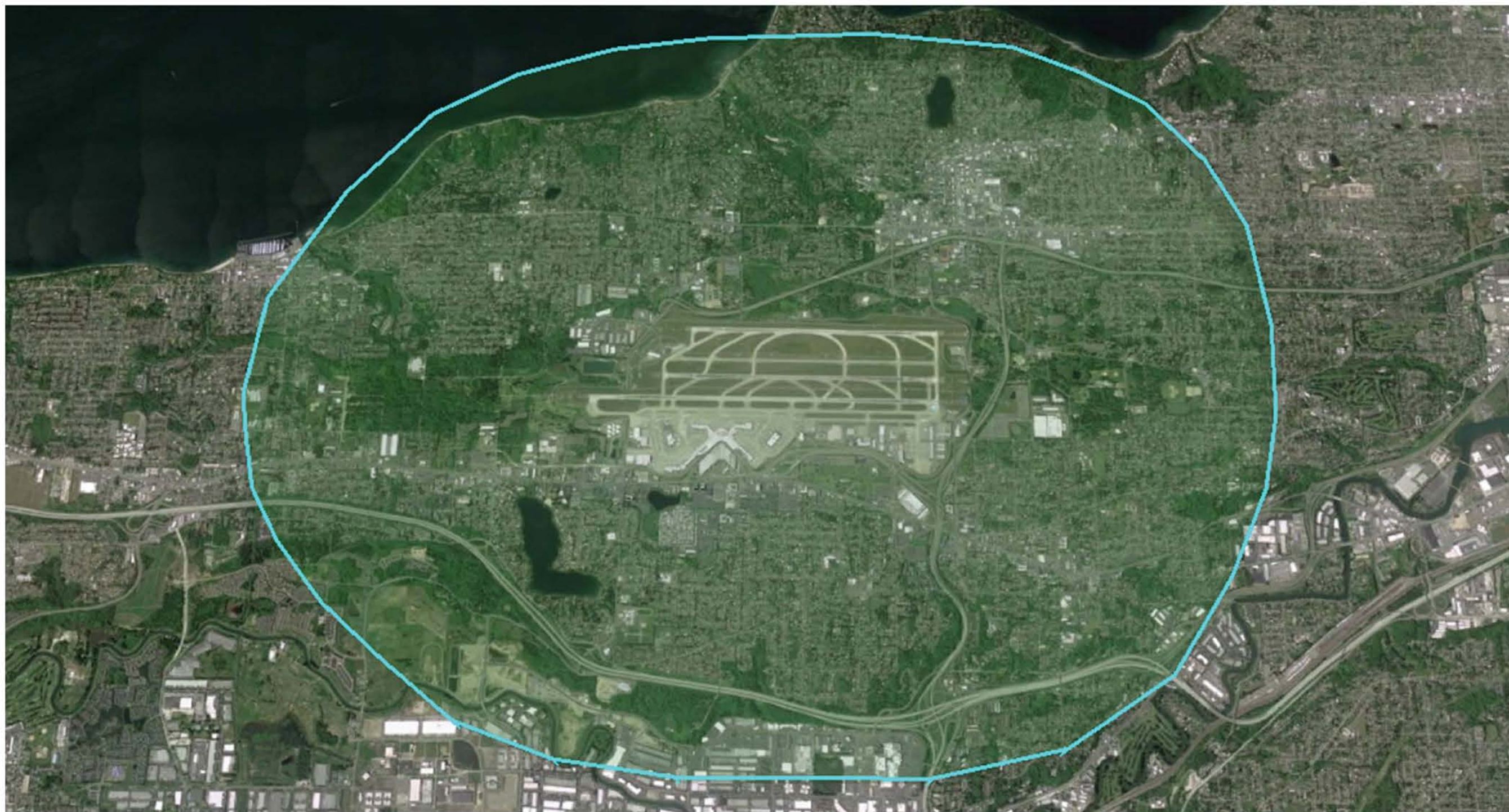
- 1. Port westside offices
- 2. Terminal Radar Approach Control (TRACON)
- 3. Airport Surveillance Radar (ASR)-9 antenna

-  Airport buildings
-  Airport property line




Source: Airport Layout Plan (December 2007), updated June 2017

Figure 1-7  
FAA Critical Zone for Wildlife Management  
Seattle-Tacoma International Airport



LEGEND

 FAA Critical Area for wildlife management boundary – 10,000' from AOA fenceline



Source: Port file, "FAA Critical Area (10,000' from AOA Fenceline at SEA)"

# Airfield

## 2.1 Runways

The airfield consists of three runways and associated taxiways. Runway data, including key airfield dimensions and navigational aids, are summarized in Table 2-1.

## 2.2 Taxiways

Figure 2-1 shows the location of the taxiways that connect the runway system to the aircraft parking areas. Taxiway characteristics are summarized in Table 2-2.

## 2.3 Non-Conforming Airfield Conditions

Airfield components which do not meet current Federal Aviation Administration (FAA) airport design standards (FAA Advisory Circular 150/5300-13A, *Airport Design*) and have been accepted by the FAA through the issuance of a modification to airport design standards are shown in Table 2-3.

## 2.4 Airfield Operations

The following sections describe the typical wind and weather patterns in the region, as well as the general operating procedures put in place by the Port and FAA.

### 2.4.1 Weather Occurrence

Weather conditions—namely cloud ceiling and visibility—determine the procedures that can be used at the Airport, which in turn affect runway capacity and aircraft delay.

- Significant increases in cargo warehouse capacity are needed.
- FAA Aviation System Performance Metrics (ASPM) database defines Visual Meteorological Conditions (VMC) as cloud ceilings at least 4,000 feet and visibility of at least three miles, and Instrument Meteorological Conditions (IMC) with cloud ceilings less than 4,000 feet or visibility less than three miles.
- Based on the ASPM database, for the ten-year period from 2004 through 2013, VMC occurred approximately 65 percent of the time, and IMC occurred 35 percent of the time.
- Weather occurrence will be refined based on data from the National Climactic Data Center in support of the airfield capacity analysis.

### 2.4.2 Runway Use Patterns

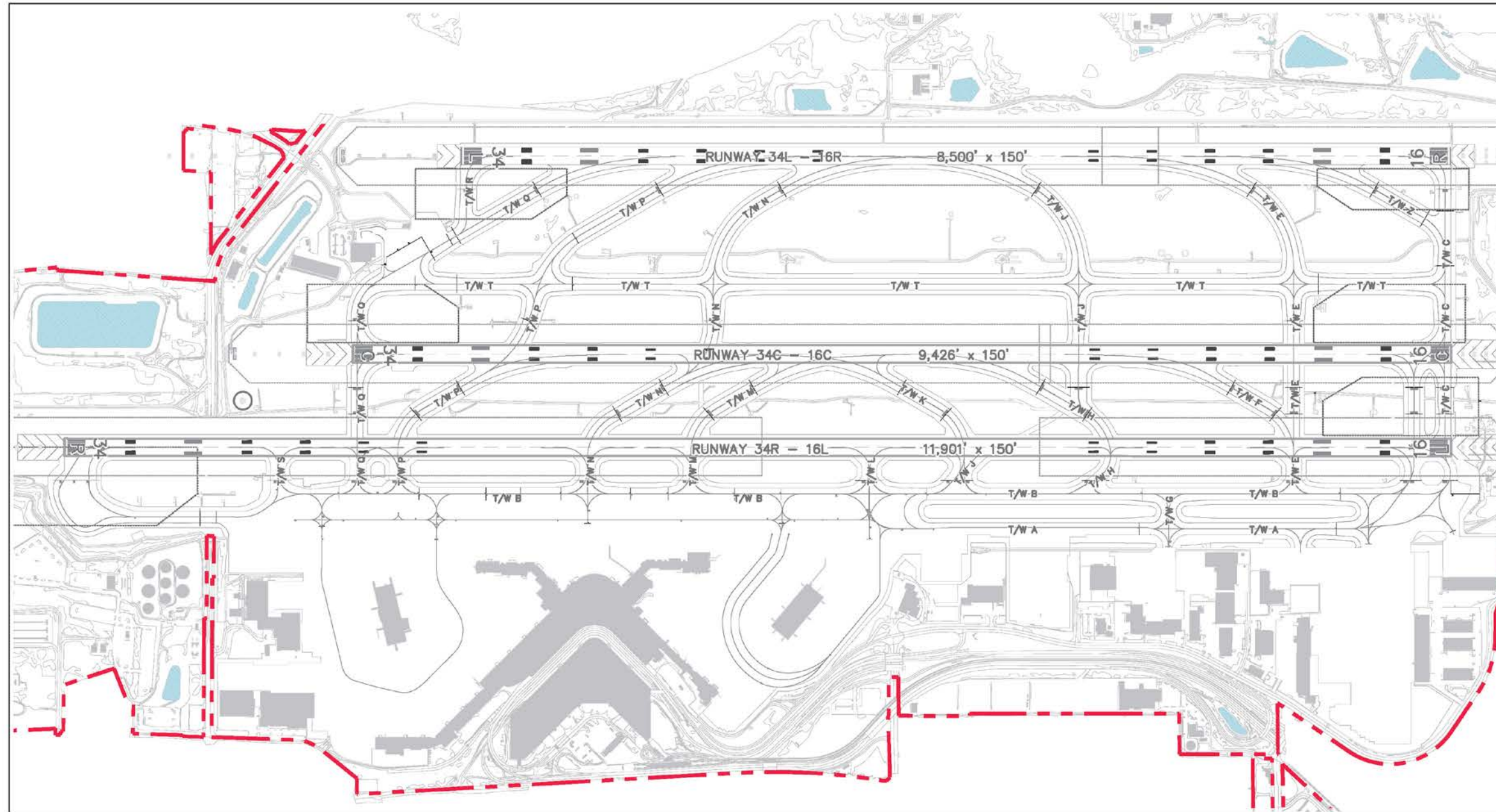
Direction of air traffic flow is dictated primarily by prevailing wind and weather conditions, as well as air traffic procedures, capacity considerations, and noise abatement procedures.

- The two predominant runway operational configurations, north and south flows, are shown on Figure 2-2.
- Due to prevailing winds, south flow is the preferred mode of operation. For the five-year period from 2009 through 2013, north flow occurred 27 percent of the time and south flow occurred 73 percent of the time, according to FAA ASPM.
- The Noise Abatement Informal Runway Use Program outlines preferred runway uses.
- Visual approaches can be conducted with a ceiling of greater than 5,000 feet and visibility greater than five miles. The primary arrival runway is Runway 34L-16R, with offload to Runway 16L-34R and 16C-34C. The primary departure runway is Runway 16L-34R, with offload to Runway 16C-34C. This configuration is only used during periods of low demand.
- Instrument approaches are conducted with a ceiling less than 5,000 feet or visibility lower than five miles. The primary arrival runway is Runway 34L-16R, with offload to Runway 16L-34R. The primary departure runway is Runway 16L-34R. This configuration is also used during periods of high demand, irrespective of weather conditions.

### 2.4.3 Pavement Conditions

Pavement conditions were assessed by the Port of Seattle in 2016, and are provided in Appendix A.

Figure 2-1  
**Airfield/Taxiway Designations**  
 Seattle-Tacoma International Airport



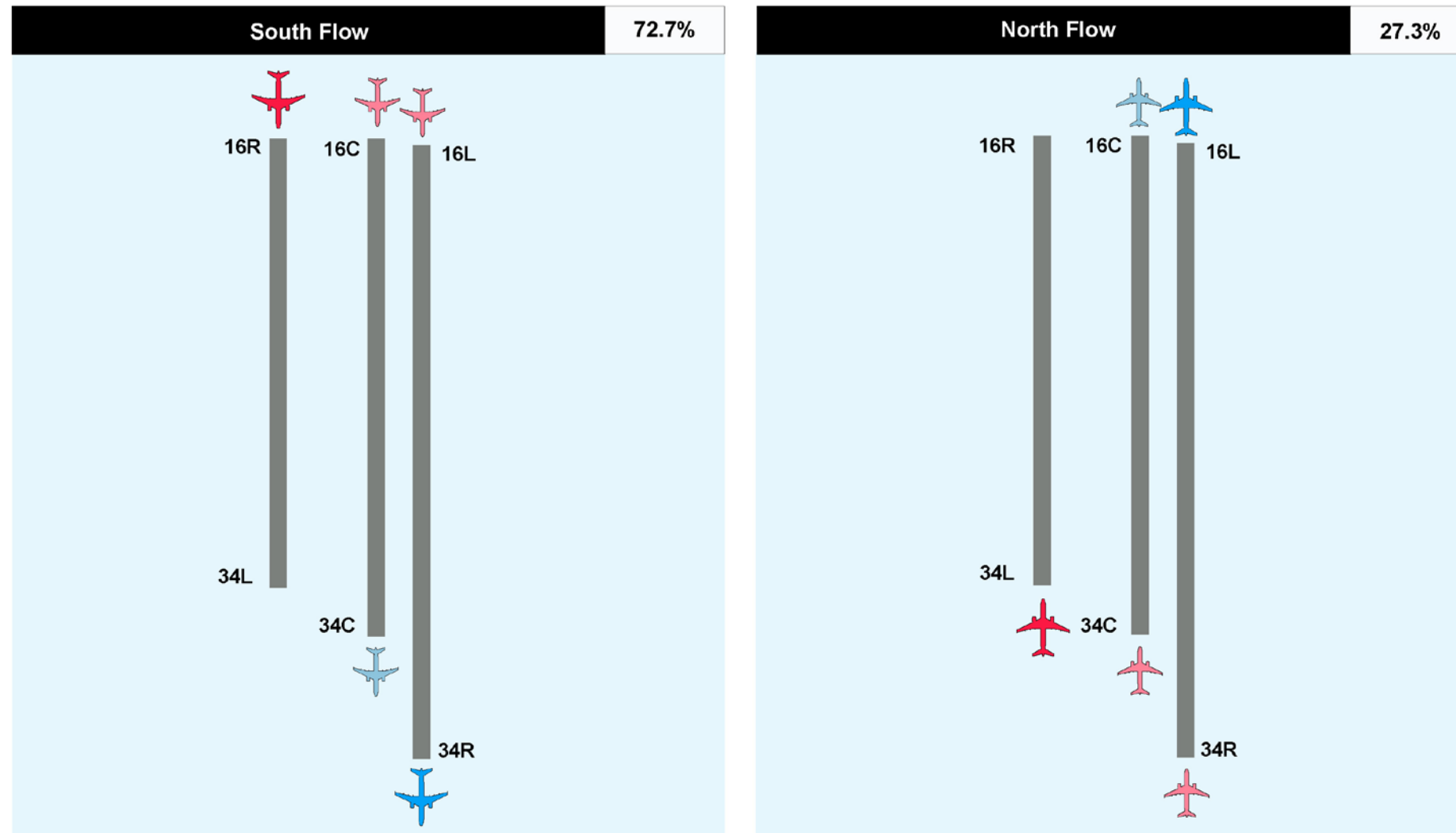
LEGEND

- Airport buildings
- Airport property line





0 800 1600 ft.

Source: Port "Airport Facilities" drawing (June 2014), updated June 2017

Figure 2-2  
**Primary Runway Use Configurations**  
 Seattle-Tacoma International Airport



**LEGEND**

 Primary Departure	 Primary Arrival
 Secondary Departure	 Secondary Arrival

Source: LeighFisher analysis of runway use data from FAA Aviation System Performance Metrics database for 2009–2013, updated June 2017



Table 2-1  
**Runway Data**  
 Seattle-Tacoma International Airport

	Runway					
	16L	34R	16C	34C	16R	34L
Runway length (feet)	11,901	11,901	9,426	9,426	8,500	8,500
Runway width (feet)	150	150	150	150	150	150
Runway end elevation (feet above MSL)	433	347	430	363	415	356
Pavement type/friction	Concrete/grooved	Concrete/grooved	Concrete/grooved	Concrete/grooved	Concrete/grooved	Concrete/grooved
Pavement strength (000 pounds)						
Single gear	100(S)	100(S)	120(S)	100(S)	100(S)	100(S)
Dual gear	230(D)	230(D)	250(D)	200(D)	216(D)	216(D)
Dual tandem gear	600(2D)	600(2D)	550(2D)	350(2D)	448(2D)	448(2D)
Double dual tandem gear	1400(2D/2D2)	1400(2D/2D2)	1128(2D/2D2)	880(2D/2D2)	1157(2D/2D2)	1157(2D/2D2)
Runway markings	Precision	Precision	Precision	Precision	Precision	Precision
Runway lighting	HIRL	HIRL	HIRL	HIRL	HIRL	HIRL
Centerline lights	Yes	Yes	Yes	Yes	Yes	Yes
Approach lighting	ALSF-II	MALSR	ALSF-II	MALSR	ALSF-II	MALSR
Approach Aids						
	TDZ	TDZ	TDZ	LOC	TDZ	LOC
	LOC	LOC	LOC	GS	LOC	GS
	GS	GS	GS	PAPI	GS	PAPI
	PAPI	PAPI	PAPI		PAPI	
Instrument approach procedures	ILS (CAT I, II, IIIB) RNAV(GPS)	ILS (CAT I) RNAV(GPS)	ILS (CAT I, I, IIIB) RNAV(GPS)	ILS (CAT I) RNAV(GPS)	ILS (CAT I, II, IIIB) RNAV(GPS)	ILS (CAT I) RNAV(GPS)
Minimum approach decision height (feet above MSL)	n.a.	547	n.a.	580	n.a.	556
Minimum approach visibility	300 RVR	1800 RVR	300 RVR	2400 RVR	300 RVR	2400 RVR

Notes:

- ALSF-2 = High-intensity approach light system with centerline sequenced flashers
- CAT = Category
- GPS = Global positioning system
- GS = Glide slope
- HIRL = High-intensity runway light
- ILS = Instrument landing system
- LOC = Localizer
- MALSR = Medium-intensity approach light system with runway alignment indicator lights
- MSL = Mean sea level
- PAPI = Precision approach path indicator
- RNAV = Area navigation
- RVR = Runway visual range

Source: 5010 FAA Form,

Port of Seattle, 2014. Updated May 2017.

Table 2-2  
**Taxiway Characteristics**  
 Seattle-Tacoma International Airport

Taxiway designation	Type	Location	Width	Length	Exit geometry
A	Parallel	East side, north of Taxiway L, runs to Taxiway D	100	5,000	n.a.
B	Parallel	East side, from South Apron to North Apron	100	12,700	n.a.
C	Connector	North End, connecting Runways 16L, 16C, 16R	100	2,300	n.a.
D	Connector	North End, Taxiway B to Runway 16L-34R and 16C-34C	100	750	n.a.
E	Exit, Connector	North End, exiting for Runway 34L, connecting Taxiway T, Runway 16C-34C, 16L-34R and Taxiway B	100	2,600	30 degrees
F	Exit	North End, exiting from Runway 34C, to TW E	100	1,000	30 degrees
G	Connector	North end, east side, connecting Taxiway A and Taxiway B	100	150	n.a.
H	Exit	North End, exiting from Runway 34C & Runway 16L to Taxiway B	100	1,800	30 degrees
J	Exit, Connector	North End, exiting for Runway 34L, connecting to Taxiway T, exiting for Runway 16C and 16L to Taxiway B	100, 75	3,750	30 degrees 45 degrees
K	Exit	North End, exiting from Runway 34C to Taxiway J	100	1,100	30 degrees
L	Connector	East side, connecting Runway 16L-34R to Taxiway B	100	250	n.a.
M	Exit, Connector	South End, exiting Runway 16C, connecting Taxiway B	100	250	30 degrees
N	Exit, Connector	South End, exiting Runway 16R, connecting Taxiway T, exiting Runway 16C, connecting Taxiway B	100	3,100	45 degrees 30 degrees
P	Exit, Connector	South End exiting Runway 16R, connect to Taxiway T, exiting Runway 16C, connecting Taxiway B	100	3,700	30 degrees
Q	Exit, Connector	South End, exiting Runway 16R, connecting Taxiway T, exiting Runway 16C and Runway 16L connecting Taxiway B	100	3,550	30 degrees 90 degrees
R	Exit	South End, exiting Runway 16R, connecting Taxiway Q	100	400	90 degrees
S	Exit	South End, exiting Runway 16L	100	300	90 degrees
T	Parallel	West side, between Runways 16R-34L and 16C-34C from Taxiway C to Taxiway Q	100	9,300	n.a.
Z	Exit	Exiting Runway 34L, connecting Taxiway C	100	1,200	30 degrees

Notes:

Location Example For T/W C = North end connecting Runways 16L, 16C, 16R

North End = North of LAT 47d, 27m N

South End = South of LAT 47d, 27m N

Source: Port of Seattle; Seattle-Tacoma International Airport Layout Plan, 2007.

Table 2-3  
**Modification to Standards**  
 Seattle-Tacoma International Airport

Design element	Standard	Existing Condition	Cause of Condition	Mitigation Justifying Modification to Standards	Date Issued
FAA Part 77 - Aircraft Parked at Concourses B&C	No surface penetration	Aircraft tails penetrate 7:1 primary surface	Runway/terminal proximity	None	1/16/1981
FAA Part 77 - Aircraft Parked at N&S Satellites	No surface penetration	Aircraft tails penetrate 7:1 primary surface	Runway/terminal proximity	None	1/16/1981
FAR Part 77 Surfaces - Parked A/C at Concourse B, C, N & S Satellites	No Surface Penetration	Vertical tail sections penetrate	Terminal location	None	1/16/1981
Taxiway A Object Free Area	160 feet from centerline to fixed or moveable object (ADG V)	154 feet on east side	Retaining wall along service road	None	12/21/1987
FAA Part 77 - Aircraft Parked at Concourses B&C	No surface penetration	Light standards penetrate 7:1 primary surface	Runway/terminal proximity	None	9/13/1990
FAR Pat 77 Surfaces - Light Standards on Concourse B&C	No Surface Penetration	Standards penetrate by 34 feet	Terminal location	None	9/13/1990
Runway 16L Pavement Crown	On centerline	Offset 25 feet to 50 feet east	Original runway construction	None	4/15/1992
Surface markings - Taxiway H & J Holdlines	Perpendicular to taxiway centerlines	Parallel to runway centerline	Taxiway geometry	None	5/20/1992
Surface Markings - Taxiway Holdlines H&J (Old B2&B3)	Perpendicular to TW centerlines	Parallel to runway centerline	Taxiway geometry	None	5/20/1992
Low Visibility Taxiway Lighting System	5 -foot intervals between clearance bar lights	10 foot intervals between clearance bar lights	Installed prior to AC publication	None	10/4/2002
Low Visibility Taxiway Lighting System	Non-standard installation of lights		Installed for demo project prior to AC publication	None	10/4/2002
Taxiway Centerline Light Lead Off Lights	No lead off lights above 1200-foot RVR	No edge lights installed, need centerline lights	Lighting system design	None	2/14/2008
Taxiway Centerline Lights Color Coded Inside Runway Holdlines	Color coding inside runway holdlines and ILS holdlines	Color code only inside Runway holdlines	Taxiway Geometry	None	2/14/2008
B747-8 Operational Plan – Runway 16L/34R-Taxiway B Separation	550 feet for ARC D-VI	400 feet	B747-8 larger wingspans	All B747 must use Taxiway A during low-visibility conditions	12/2/2008
B747-8 Operational Plan - Taxiway A&B Object Free Area Width	386 feet for ARC D-VI	300 feet	B747-8 larger wingspans	Calculate OFA using formula per aircraft instead of entire Group standard	12/2/2008
B747-8 Operational Plan - Taxiway C&D Wingtip Clearance BTN Runway 16L/34R and 16C/34C	62 feet wingtip clearance	54.88 feet	B747-8 larger wingspans	Calculate wingtip clearance using formula per aircraft instead of entire Group standard and limit other aircraft when the B747-8 is on either C or D taxiways	12/2/2008
B747-8 Operational Plan - Taxiway C&D Wingtip Clearance at North Hold Apron	62 feet wingtip clearance	54.88 feet	B747-8 larger wingspans	Calculate OFA using formula per aircraft instead of entire Group standard	12/2/2008
B747-8 Operational Plan - Taxiway B & Taxilane W Wingtip Clearance	62 feet wingtip clearance	42.3 feet	B747-8 larger wingspans	Allowed under approved MOD	12/2/2008
B747-8 Operational Plan - Taxiway Fillet Dimensions	Group VI	Group V	B747-8 larger wingspans	None	12/3/2008
Taxiway B Wingtip Clearance to Vehicle Service Road	193 feet for ARC D-VI	167 feet	B747-8 larger wingspans	The POS will move a section of the road	12/4/2008
Taxiway Q OFA at FBO	386 feet for ARC D-VI	320 feet	B747-8 larger wingspans	Calculate OFA using formula per aircraft instead of entire Group standard	12/5/2008
Taxiway A & Retaining Wall/Vehicle Service Road	62 feet wingtip clearance	54 feet	B747-8 larger wingspans	Calculate OFA using formula per aircraft instead of entire Group standard	12/6/2008

Table 2-3 (continued)  
**Modification to Standards**  
 Seattle-Tacoma International Airport

Design element	Standard	Existing Condition	Cause of Condition	Mitigation Justifying Modification to Standards	Date Issued
Runway Width & Blast Pad Sizes, All Runways	200-foot Runway with 40-foot shoulders. Blast Pads 280 feet wide by 400 feet long	All runways 150 feet wide. Runway 16L & 16R shoulders are standard 35 feet. Runway 16C shoulders are 25 feet. Blast Pad sizes vary per Runway end.	SEA is an ADV V airport. All runways meet ADV V dimensions. Runway 16L & 16R shoulders meet ADV V dimensions. RUNWAY 16C shoulders were constructed in 1972, under different standards. No clear requirement for standard pad sizes.	Increase Runway 16C shoulders to 35 feet when RUNWAY is reconstructed in 2016	8/18/2011
Taxilane W Separation	AC 150/5300-13a	Taxilane W is restricted to aircraft with 125-foot wingspans.	B767-300ER wingspans	Relocate Taxilane W centerline 13 feet to the east and the vehicle service road 17 feet to the east, to allow for the larger wingspan	12/12/2013
Taxiway B-Taxilane W Separation & Taxilane to Fixed or Movable Object Separation south of Taxiway N	232 feet and 113 feet plus submittal of a modification of airport design standards	232 feet & 113 feet	Need to allow B767-300ER with winglets to operate on Taxilane W	Relocate Taxilane W centerline 13 feet east and the vehicle service road 17 feet east	2/25/2014
Transverse Grades in the RSA (Runway 16C-34C)	1.5-inch drop from the shoulder edge followed by a 5% drop for 10 feet, followed by a 1.5% to 3% variable grade to RSA and then a 16:1 grade for 107 feet past the RSA	Existing grades adequately drain.	NA	None	4/25/2014
Runway 16C-34C Pipe for Storm Drains and Culverts	Pipes must be constructed using Concrete, PVC, or HDPE	Use of ductile iron storm drain pipe beneath the runways and taxiways	Port had previous issues with cracks and defects in concrete pipe	None	1/15/2015
WSDOT Specifications for Gravel Backfill for Pipe Bedding in Unpaved Areas (Runway 16C-34C)	Material backfill material as specified in D-701-3.5	WSDOT gravel backfill for pipe zone bedding in pipe zone for non-paved areas	It is not economical to use P-153 CLSM in non-paved areas	None	1/27/2015
Modification of FAA Specifications for Better Quality Control of Concrete Aggregate (Runway 16C-34C)	Provisions in P-501 require testing for delirious material only in the proposed design mix	Test for deleterious substances as part of the mix design, and during concrete production for each lot of concrete. Submit test reports within 21 days of placement.	Issues with pop-outs on Runway 16R-34L	None	1/28/2015
Longitudinal Profile with Vertical Curve Placement Within the Last 25% of End of Runway 16C-34C	No grade changes are allowed in the first and last quarter of the runway length	Grade of 0.36% and then 0.80% with associated grade break, smoothed by way of a 1,600-foot vertical curve	Extensive reconstruction and grading would be needed	None	4/22/2015
Runway 16L-34R Separation to Parallel Taxiway B	Approach Reference Code—D-V Runway to Taxiway separation is 500 feet; D-VI Runway to Taxiway separation is 550 feet  Departure Reference Code-- Runway to Taxiway separation is 500 feet for unrestricted operations and 400 feet for restricted operations by ADG-VI aircraft	Runway to Taxiway separation is 400 feet north of Taxiway S	Taxiway B cannot be relocated at this time because of impacts to adjacent facilities	Letter of agreement (LOA) with Seattle Airport Traffic Control Tower (ATCT) and Port of Seattle Ramp Tower (SRT), and ATCT standard operational procedures will facilitate control of aircraft movements on Taxiway B and avoid limiting approaches to Runway 16L-34R in any way. LOA will include procedures where ATCT will advise SRT when RVR drops below 2400 and then airlines will request a 30-minute Prior Permission Required (PPR) from the SRT. This will permit the SRT to plan movements to meet requirements and communicate with ATCT. Operational procedures to separate aircraft will be documented in a LOA between the ATCT and SRT.	12/21/17

Source: Port of Seattle, 2017.

# Passenger Terminal

## 3.1 Introduction

The physical arrangement of the Airport's passenger terminal is illustrated in Figure 3-1.

As of March 2015, the Airport serves a total of 23 airlines; 12 of which are international carriers. The airlines serving the Airport are shown in Table 3-1.

### 3.1.1 Aircraft Parking

Figure 3-2 shows the locations and layouts for on-gate aircraft parking positions at the Airport (on-gate parking positions are where passengers enplane and deplane aircraft). Table 3-2 summarizes on-gate aircraft parking capabilities at the Airport and the airline gate assignments as of January 2014. As of January 2014, the Airport could accommodate a total of 92 passenger aircraft at on-gate parking positions in a maximum aircraft configuration; at 68 of these positions passengers boarded aircraft using passenger boarding bridges and at 24 of these positions, passengers were ground loaded.

Figures 3-3 and 3-4 show the locations for off-gate aircraft parking areas suitable for use by remain overnight aircraft (off-gate aircraft parking positions are not used to enplane and deplane passengers). Table 3-3 summarizes Airport-wide remain overnight aircraft parking capabilities for two aircraft mixes.

### 3.1.2 Functional Space Allocation

The Airport's passenger terminal facilities consists of the main terminal, Concourses A through D, the North Satellite, and the South Satellite. These facilities are on multiple levels, illustrated in Figure 3-5 as follows (listed from top to bottom):

- First, second, third, fourth, fifth, and penthouse levels (Airport Office Building only)
- Third and fourth levels (Central Terminal only)
- Mezzanine level
- Concourse level
- Bridge level
- Baggage level
- Satellite Transit System (STS) level

The Airport's passenger terminal occupies an area of over 3.1 million square feet, which is allocated as shown graphically in Figures 3-6 through 3-36 and in a tabular format in Tables 3-4 through 3-6. Additional facilities data are available in the Port's property management system (PROPWORKS).

The **Main Terminal**, shown in Figure 3-1, consists of pre-security functions required by enplaning and deplaning passengers. The Main Terminal building vertically segregates passenger ticketing, baggage handling/screening, building services and utilities, and supporting airline/airport offices. These are as follows (listed from top to bottom):

- The Port Police Department, Airport and other agency space are located on the third and fourth levels above the mezzanine.
- The mezzanine level overlooks the open public concourse area and houses several Airport and other agency offices as well as significant vacant space and airline operations space.
- The concourse level includes facilities for passenger processing, such as ticketing counters, baggage handling facilities, and security screening checkpoints.
- Beneath the concourse level, the bridge level includes baggage handling and screening and multiple building utilities and services spaces. There is vehicular storage for designated airport related vehicles as well as the core mechanical baggage system.
- The baggage level houses the majority of the Airport's baggage claim and handling as well as baggage security screening. Building services, concessions storage, utilities and Airport and other agency functional spaces are provided.
- The STS level provides substantial building services and utilities systems spaces. STS stations for Concourse A/SSAT and Concourse D/NSAT also exist. Airport and other agency spaces are also provided.

The main feature of the **Central Terminal**, located at the confluence of Concourses A, B, C, and D, is a grand civic space known as the Pacific Marketplace. The Pacific Marketplace consists of shops, restaurants, landscaping, a view of the airfield, and art.

**Concourse A** extends southward from the processor and provides access to the South Satellite and Concourses B, C, and D via stations on the STS level. The concourse is approximately 1,900 feet long, and consists of 14 holdrooms, each of which is equipped with a passenger boarding bridge. Currently Delta Air Lines, United Airlines, American, Air Canada and Air Canada Jazz operate from Concourse A. Boarding areas within the concourse consist of kiosks that are connected to the Airport's Common Use Terminal Equipment (CUTE) system, providing both preferred airline and general assignment flexibility. Two segments of an automated walkway assist in movements along the Concourse.

- The concourse level includes processing facilities for deplaning and enplaning passengers, as well as holdrooms, restrooms, concessions, and airline operating areas. Passengers enplane and deplane on the concourse level with minor ramping to the ticketing level of the main terminal, and then generally process through either Security Checkpoint 1, 2 or 3.

- The mezzanine level of Concourse A consists of airline clubs (United and American), as well as restrooms, Airport and other agency offices, and miscellaneous airline offices.
- At the bridge level, there is non-public space that includes airline offices, baggage office, Airport and other agency offices.
- The baggage level of the concourse consists of concession and other storage, maintenance and building services shops, baggage handling, airline offices, and shipping/receiving areas. Pre-screening areas include baggage claim carousels and the Gina Marie Lindsey Arrivals Hall. This area also includes limited concessions and ground transportation services (Airporters and Charter Buses).

**Concourse B** extends from its junction with Concourse A, just south of the Central Terminal Area and westward towards the airfield. This concourse is approximately 830 feet long and has 13 holdrooms, each of which is equipped with a passenger boarding bridge. Delta Air Lines, Southwest Airlines, and Virgin America operate at Concourse B. Boarding areas are equipped with CUTE system capabilities and the Port maintains two gates for their use and assignment to airlines as necessary.

- The concourse level includes processing facilities for deplaning and enplaning passengers, as well as airline operations and storage, holdrooms, restrooms, concessions areas, and the Delta President's Club. Passengers enplane and deplane on the concourse level with a single internal ramp to accommodate vertical transitions. In general, passengers enplane after processing through Security Checkpoints 2 or 3.
- The bridge level includes airline operations and storage space, building utilities and services space, security screening support space, and vacant areas.
- The STS level includes the STS station area.

**Concourse C** extends from its junction with Concourse D on the north side of the Central Terminal and westward towards the airfield. This concourse is approximately 830 feet long and has 16 holdrooms serving 20 on-gate aircraft parking positions; 6 parking positions are equipped with passenger boarding bridges and 14 positions are ground loaded. The holdrooms predominantly serve Horizon Air (Alaska Air Group) for their regional flights using ramp boarding/de-boarding, but also serve Alaska Airlines with ten full-service gates.

- On the mezzanine level, there are limited concession and airline space, and some vacant space.
- On the concourse level travelers will find concessions, holdrooms and other passenger service areas. Between the Central Terminal and passenger areas lie Airport and other agency offices as well as limited airline space.
- The baggage level extends for a limited length under Concourse C and contains the bulk of the baggage security screening system as well as the ramp direct baggage conveyor system. There are also spaces for Airport operations and storage, utility and building services.

- The Concourse C STS station is located below Concourse C.

**Concourse D** extends northward from the central terminal and the junction with Concourse C, is approximately 1,180 feet long and provides 10 holdrooms, each of which is equipped with a passenger boarding bridge. Concourse D serves Alaska Airlines, American Airlines and JetBlue. All agent and boarding areas have been upgraded to the CUTE system but generally operate as preferred airline gates. The Port controls the use of Gates D4. There is direct post-security connection with the STS station serving the North Satellite through the Concourse D circulation area.

- On the concourse level passengers are provided concessions and services in addition to holdrooms. There is airline operations space located at the Central Terminal end of the concourse. Passengers generally enter through Security Checkpoints 4 and 5.
- The bridge level of Concourse D provides substantial airline operations and baggage handling space.
- An STS station is accessed at the north end of Concourse D.

The **North Satellite (NSAT)** is accessed by passengers via the STS system. The NSAT has 13 holdrooms serving as many as 19 on-gate aircraft parking positions, 12 of which are equipped with passenger boarding bridges. At this time, the existing concourse level contains concessions, holdrooms, and passenger services. The baggage level consists of bag handling systems as well as building services and utilities, concessions storage and airline operating spaces. In addition to the STS station the STS level consists of airline operating offices, as well as passenger service areas and utility rooms.

This facility is subject to the ongoing expansion and renovation plans, allowing it to be used exclusively by Alaska Air Group. Currently, the expansion plans that are part of the Airport's NSTAR program will expand the facility by approximately 150,300 square feet and will result in a total of 20 gates. In addition to a 10,000 square feet Alaska Airlines Board Room and increased airline support spaces, the planned improvements will provide open consolidated holdrooms and substantially increase concessions areas adjacent to and open to holdrooms.

The **South Satellite (SSAT)** is accessed by passengers via the STS station located below Concourse A. The SSAT has 14 holdrooms serving 15 on-gate aircraft parking positions, 14 of which are equipped with passenger boarding bridges. The SSAT concourse level serves as the arrivals and processing center for international flights. This facility is also the subject of current planning and design efforts for the complete relocation of Customs and Border Patrol (CBP) processing of passengers to a new International Arrival Facility (IAF) adjacent to Concourse A. All international airlines arrive at this facility and it also serves as a hub for outbound international as well as connecting domestic flights, predominantly by Delta Air Lines. As such, the Port maintains six gates under the CUTE system.

- The concourse level provides holdrooms, concessions, and passenger services including the Delta Club.
- Below the concourse lies the secure corridor and federal inspection services (FIS) level. The bridge level provides space for baggage handling, airline ramp operations and building

systems utilities. There is also a sub-bridge or tunnel level that provides additional baggage handling or ramp operations space, while also serving as the portal to baggage and utility tunnels.

- The penthouse level includes the FIS core of the building and agency space.
- The FIS level where passport control, primary and secondary inspection occur are below that baggage and STS exit level.

### **3.1.3 Airline Ticketing**

All airline ticketing services occur on the ticketing level of the main terminal. The Port divides the ticketing areas into seven ticketing zones, but only six are continuously active as Zone 7 is only used to handle seasonal air-to-sea cruise ship passengers. Airline zone assignments are shown in Table 3-7.

Table 3-7 also identifies the check-in, ticketing and bag-drop facilities, including the number of self-serve kiosks and CUTE system availability. The CUTE system is essential in the allocation of ticket counters and baggage systems in Zones 1 and 2, which predominantly serve international carriers. There are 203 agent stations provided within the ticketing zones. Zone 7, has six positions available and is subject to adjustments. In addition, five airlines provide curbside check-in using 17 check-in stations with baggage feed to the baggage security screening system.

In recent years investments by the Airport and the airlines in technology have successfully reduced passenger processing times during ticketing. These investments have included CUTE system, ticket counter pushbacks, 190 self-service kiosks, and most significantly, flow through passenger processing by Delta and Alaska airlines. These investments have also resulted in reduced needs for airline ticketing office (ATO) space, summarized in Table 3-4. At this time the airlines lease approximately 125,000 square feet of office functional space with 24,170 square feet designated as ticketing office and related supporting services.

### **3.1.4 Passenger Security**

Similar to other airports, the Airport remains in a state of change relative to passenger security screening and airport security. At this time, the Transportation Security Administration (TSA) remains responsible for the operation of five security checkpoints. The number in operation at any time is subject to airline schedules and management by TSA. Figure 3-38 illustrates the location of the checkpoints. Figures 3-39 through 3-43 illustrate the specific areas and their basic equipment layout. In general, the Airport and TSA have reached a level of continuity in their layout and equipment over the past few years. Basic equipment includes walkthrough metal detectors, Rapiscan and Heimann X-ray machines, and Explosive Trace Detection stations. Table 3-9 presents the characteristics of each security checkpoint.

The passenger terminal public circulation areas provide main access and queuing space for the security checkpoints. Over the past few years the requirements for pre-processing queuing have resulted in significant encroachment on terminal circulation space. There is also regular revision to the number and length of queue lines. Thus the parameters shown in the table represent the observation on a specific date. At this time the Airport is accommodating separate lanes for the TSA Pre-Check Program, premier

passengers, known flight crew, and the general passenger. Renovations to security checkpoints have resulted in needed office space for TSA but it is not available at every checkpoint.

### **3.1.5 Concessions**

The Airport has received accolades from the industry for its concessions program. The Airport has accomplished this by providing a core group of passenger services with a unique blend of strategically located restaurants and specialty stores. Post-security concessions are located in the Central Terminal and at other concourses. The concessionaires currently operating at the Airport are shown in Table 3-10.

### **3.1.6 Concourse and Satellite Holdrooms**

Over the last 15 years passenger gate and holdroom layouts have been in continuous transition at the Airport. The introduction of capital facilities expansion, CUTE, and airline relocations have led to a need for flexibility and more common area than airline proprietary space. The consolidation of gate service areas and the use of combined boarding corridors have enabled airlines to reduce the number of agents at those gates.

Table 3-11 presents the current gate use and holdroom area space allocation. This data was obtained through field inventory and observation and therefore the space summary should be considered approximate only. As an example, seating space is highly variable as seats may be moved and relocated by the airlines as well as passengers. The table also identifies the number of agent stations at each gate. A station was identified as such if it contained a computer terminal but boarding pass positions were not considered as agent stations. The NSTAR program will lead to a revision of this information and can be addressed at a later date.

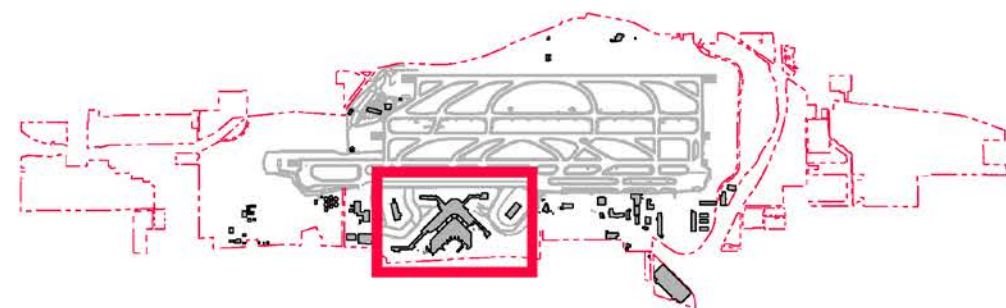
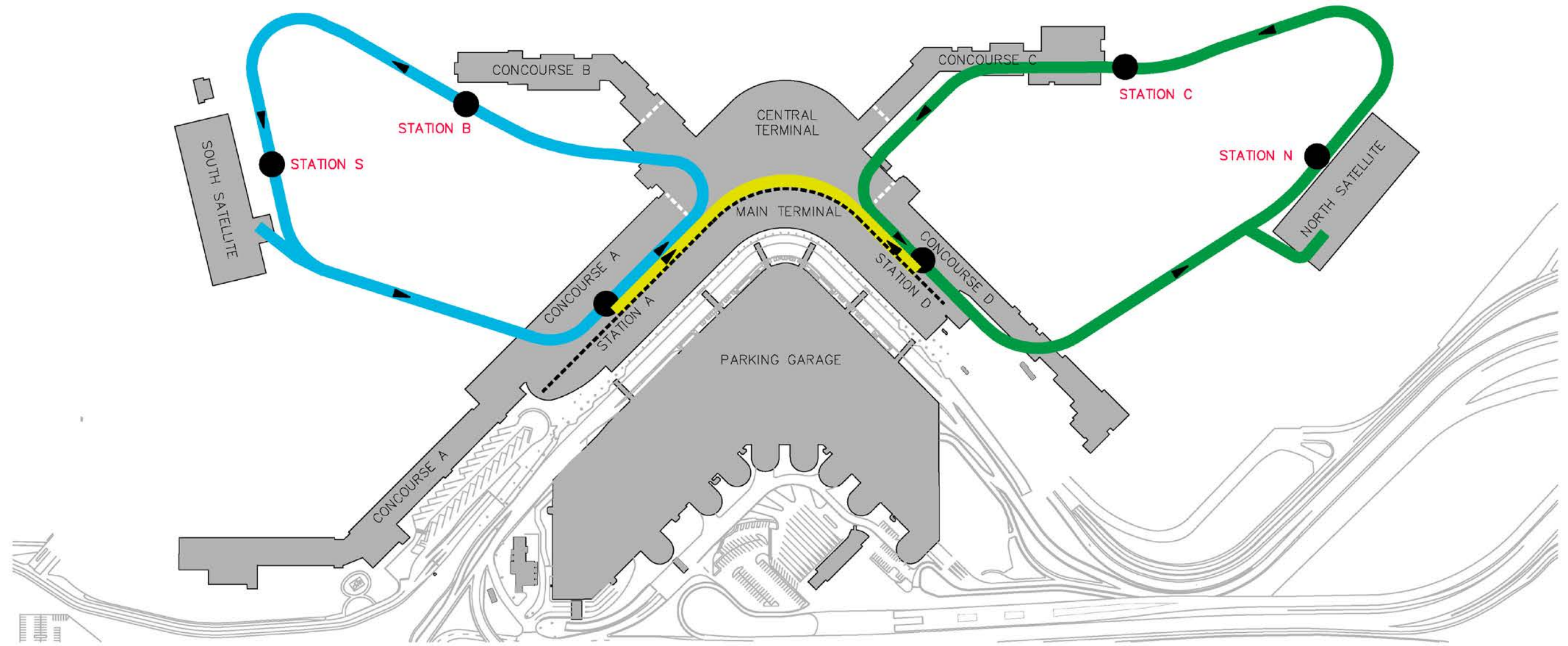
### **3.1.7 Baggage Systems**

The Airport is in the process of developing a Baggage Systems Master Plan, which is intended to outline a program of baggage system expansion and modifications that are compatible with the NSTAR program and the future IAF. The descriptions of the inbound and outbound systems are presented in Tables 3-12 and 3-13.

The existing baggage system consists of over 15 miles of conveyors, 30 screening machines and eight main inbound/outbound systems, which includes make-up devices. The Port is in the process of developing a consolidated system for bag screening which will serve all of the airlines.

Table 3-13 provides a description of the baggage claim area of the passenger terminal. There are currently 16 baggage carousels. The Port maintains control of baggage carousel 16. The carousel lies beneath the cruise ship ticketing zone of the ticketing level and is used for charter and military flights when necessary.

Figure 3-1  
**Passenger Terminal Layout**  
 Seattle-Tacoma International Airport



**LEGEND**

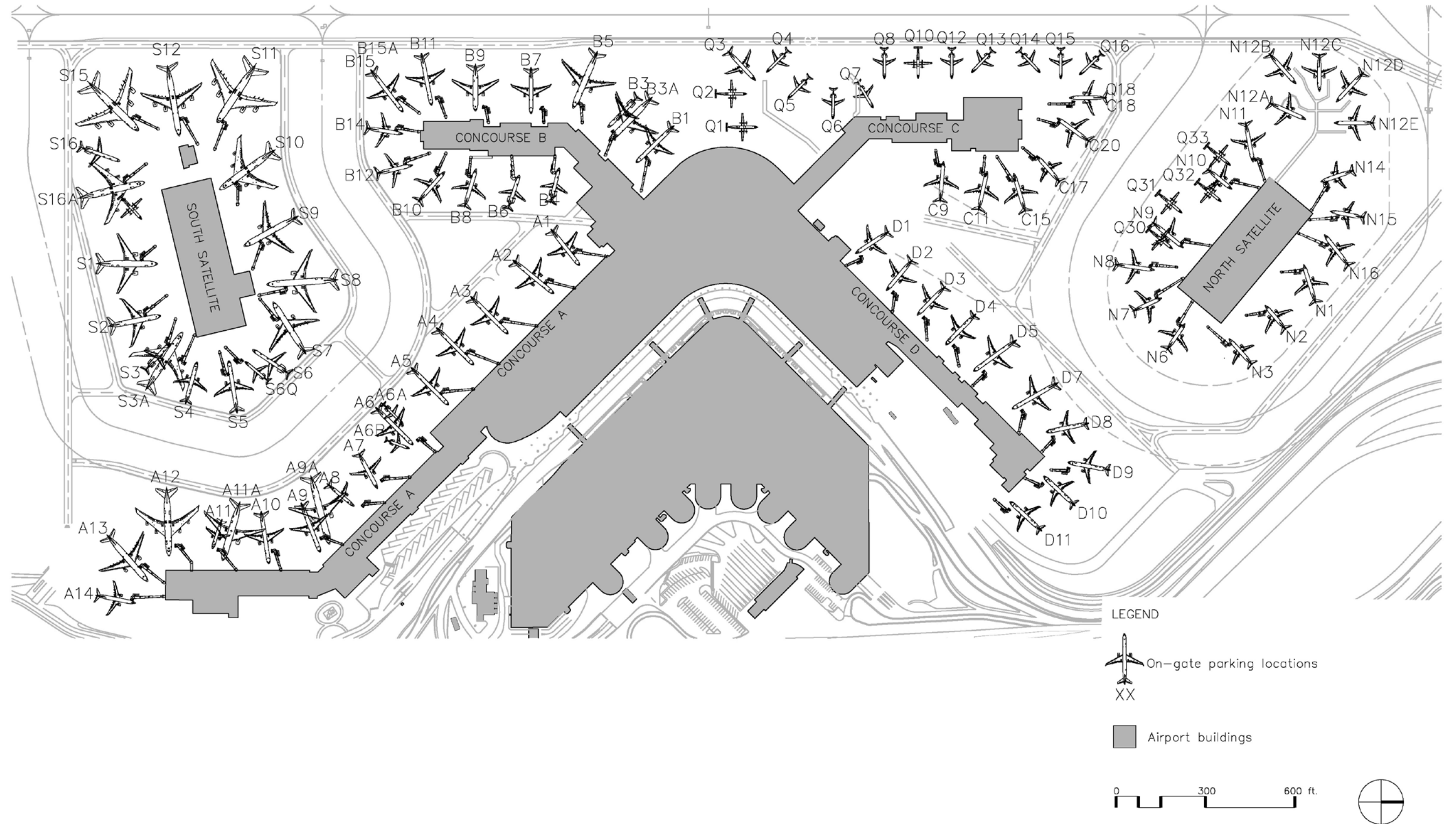
- Transit stop
- South terminal loop of Satellite Transit System (STS)
- North terminal loop of STS
- Train between Main Terminal North and South Station
- - - Secure area boundary

0 300 600 ft.

Source: STS map, Port website

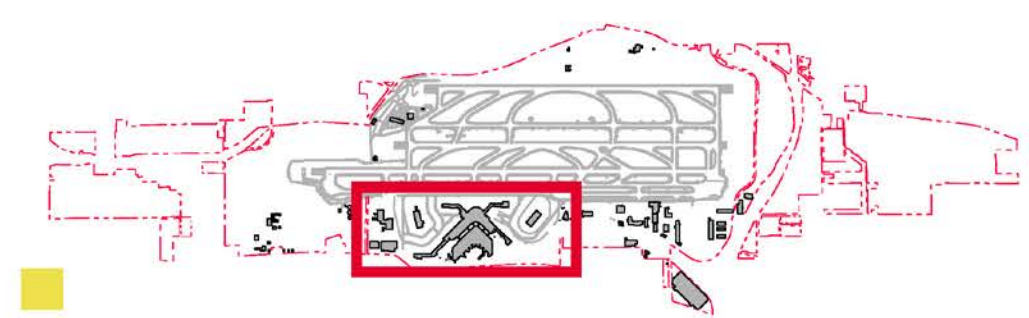


Figure 3-2  
**Gate Locations and Aircraft Parking**  
 Seattle-Tacoma International Airport



Source: Port AutoCAD file, "Site Plan\_2014.dwg" and "Airport Facilities" drawing (June 2014)

Figure 3-3  
**Off-Gate Parking at Ramp Areas (South)**  
 Seattle-Tacoma International Airport



LEGEND

Ramp locations for aircraft remain overnight parking (Table 3.3 summarizes the number of positions available)

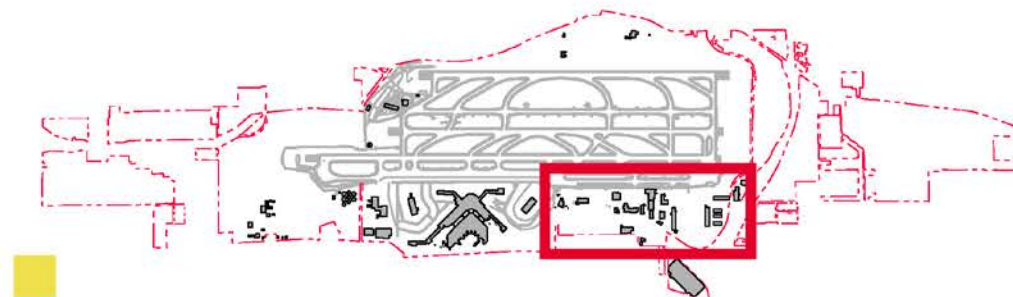
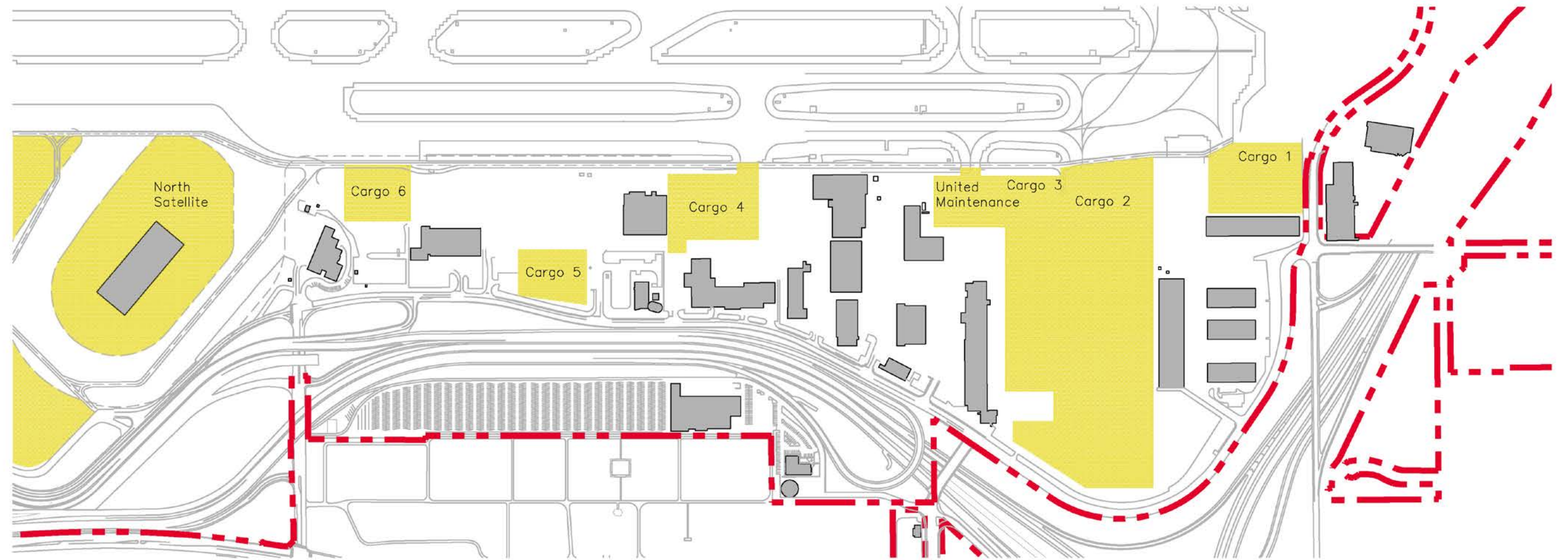
Airport property line

0 500 1000 ft.

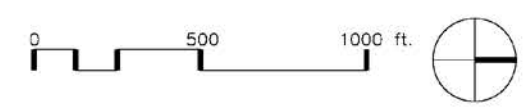


Source: Port of Seattle

Figure 3-4  
Off-Gate Parking at Ramp Areas (North)  
Seattle-Tacoma International Airport

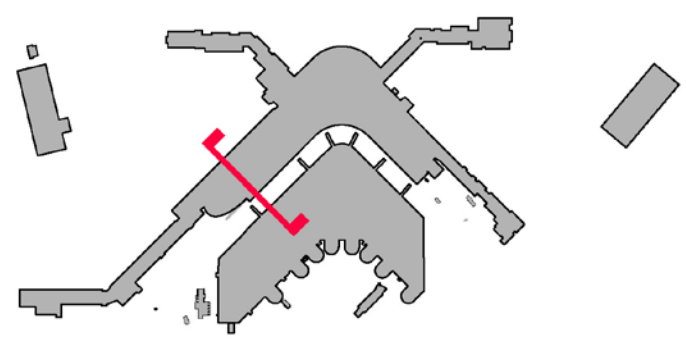
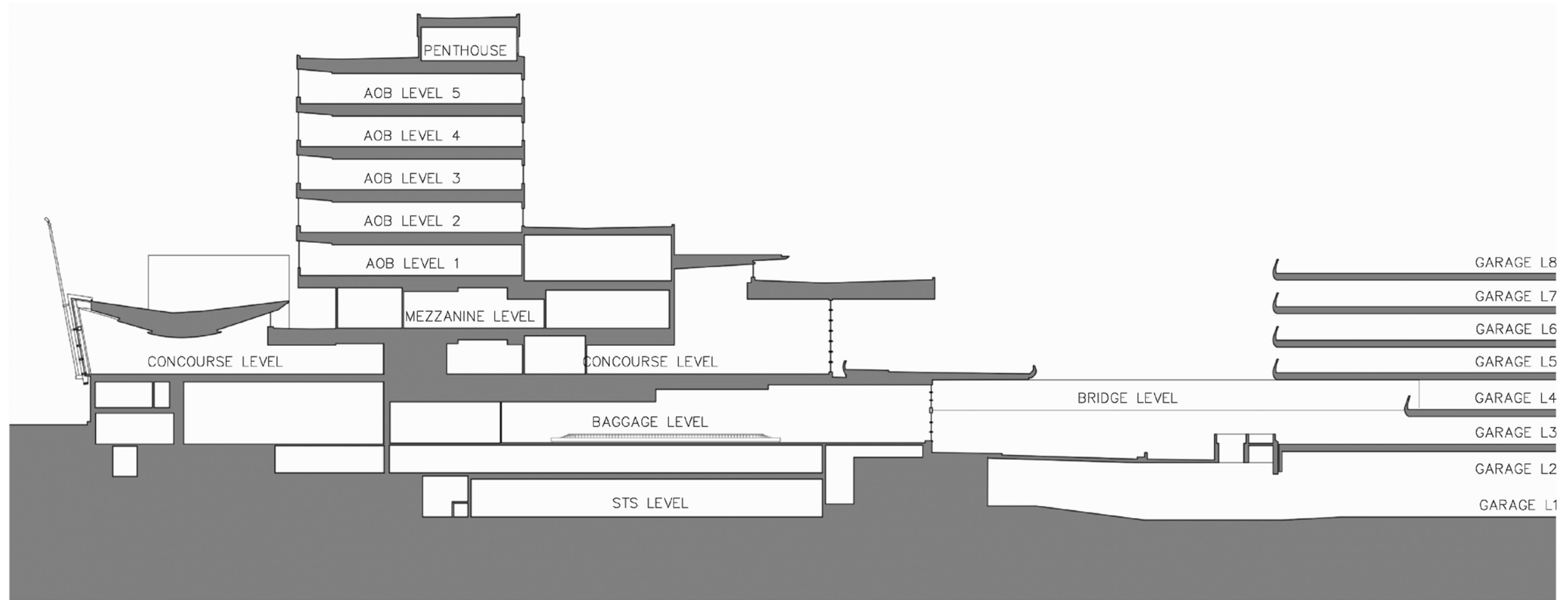


LEGEND  
Ramp areas  
Airport property line



Source: Port of Seattle

Figure 3-5  
**Airport Terminal and Concourse Levels**  
 Seattle-Tacoma International Airport

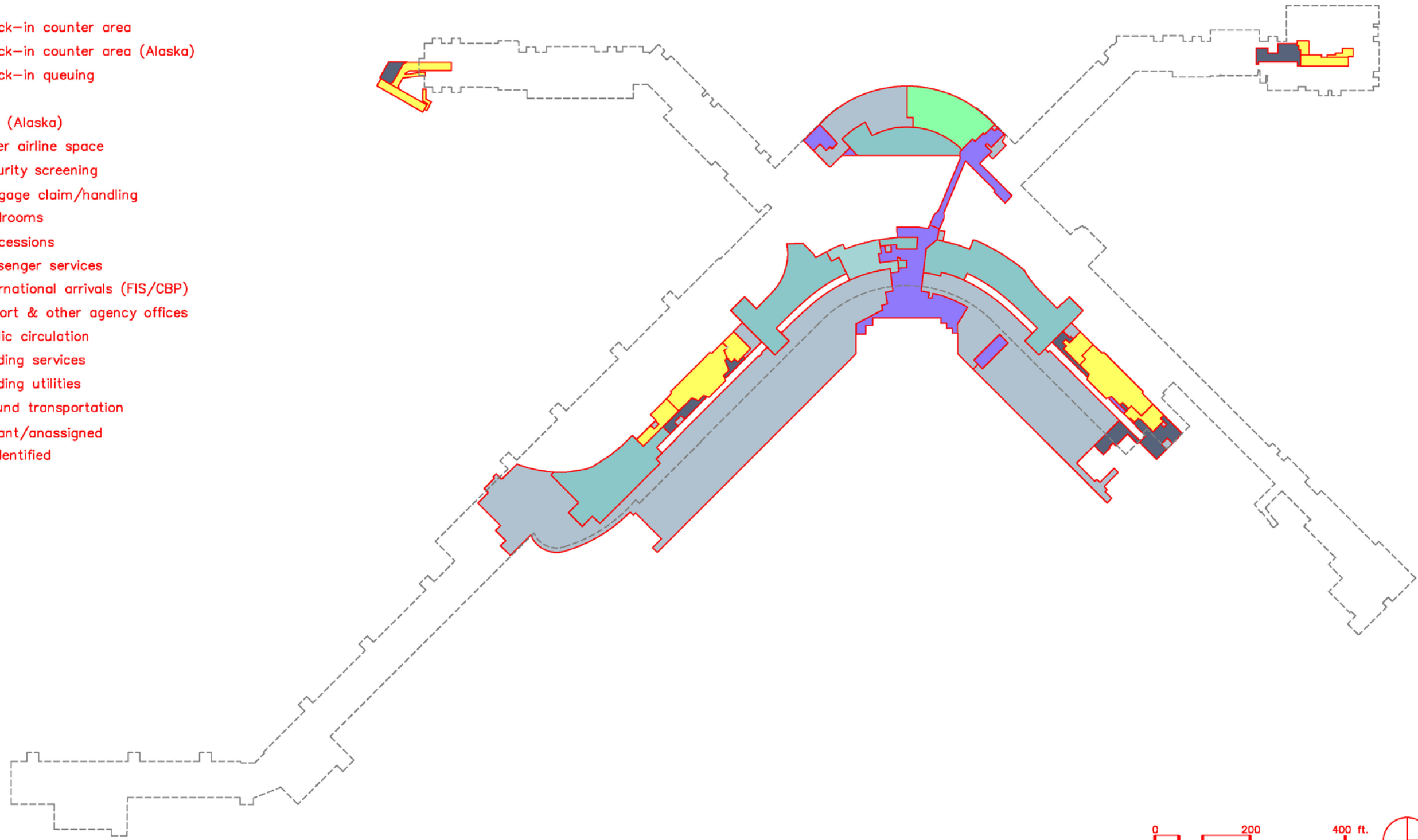


Source: Port record sets for STIA-0029 (A4.01) and STIA-6929 (A-17)

Figure 3-6  
**Overall Terminal Functional Allocation – STS Level**  
 Seattle-Tacoma International Airport

LEGEND

- Check-in counter area
- Check-in counter area (Alaska)
- Check-in queuing
- ATO
- ATO (Alaska)
- Other airline space
- Security screening
- Baggage claim/handling
- Holdrooms
- Concessions
- Passenger services
- International arrivals (FIS/CBP)
- Airport & other agency offices
- Public circulation
- Building services
- Building utilities
- Ground transportation
- Vacant/anassigned
- Unidentified

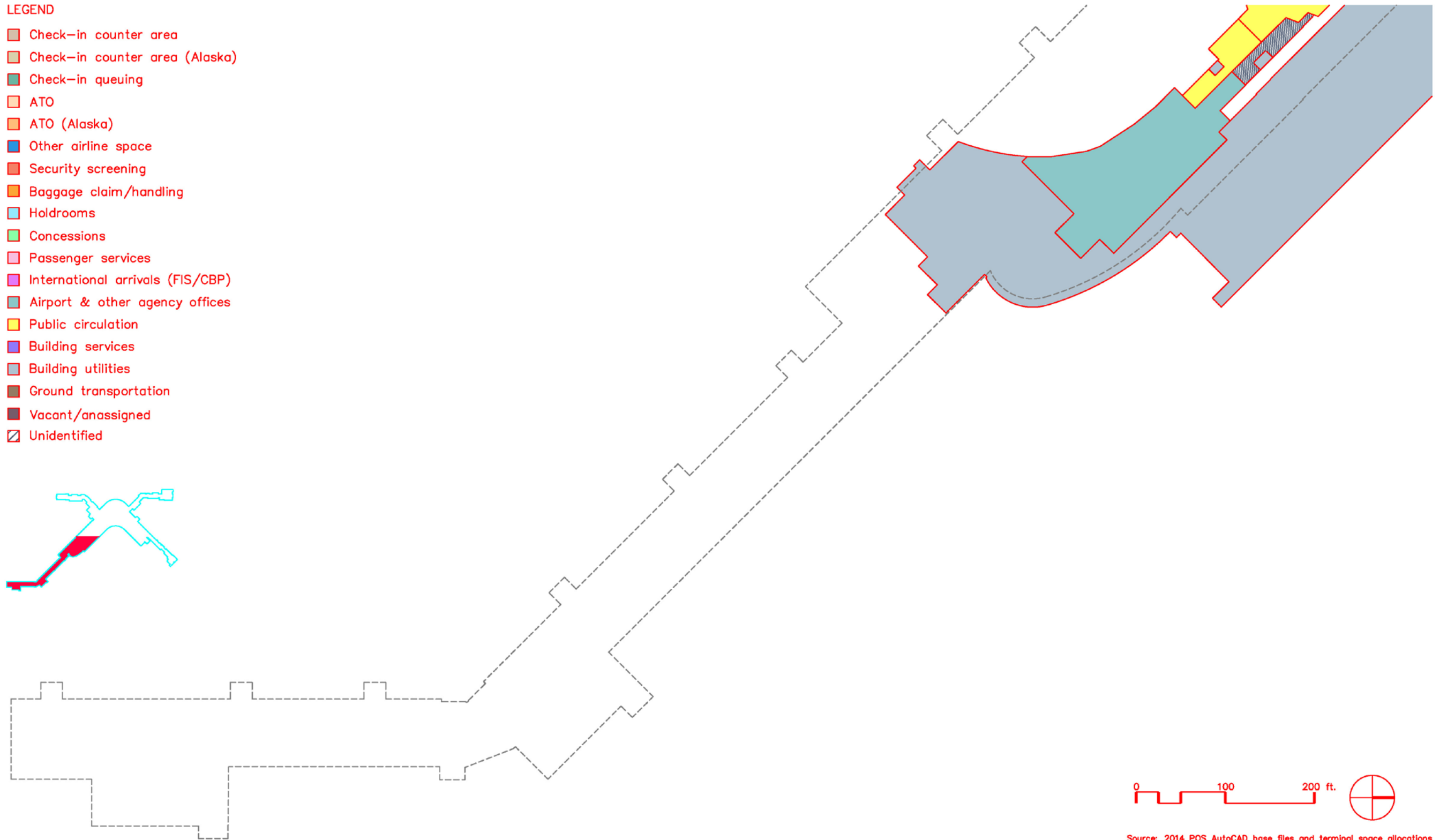
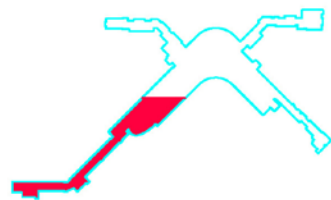


Source: 2014 POS AutoCAD base files and terminal space allocations

Figure 3-7  
**Overall Terminal Functional Allocation – STS Level Area 1**  
 Seattle-Tacoma International Airport

LEGEND

- Check-in counter area
- Check-in counter area (Alaska)
- Check-in queuing
- ATO
- ATO (Alaska)
- Other airline space
- Security screening
- Baggage claim/handling
- Holdrooms
- Concessions
- Passenger services
- International arrivals (FIS/CBP)
- Airport & other agency offices
- Public circulation
- Building services
- Building utilities
- Ground transportation
- Vacant/anassigned
- Unidentified

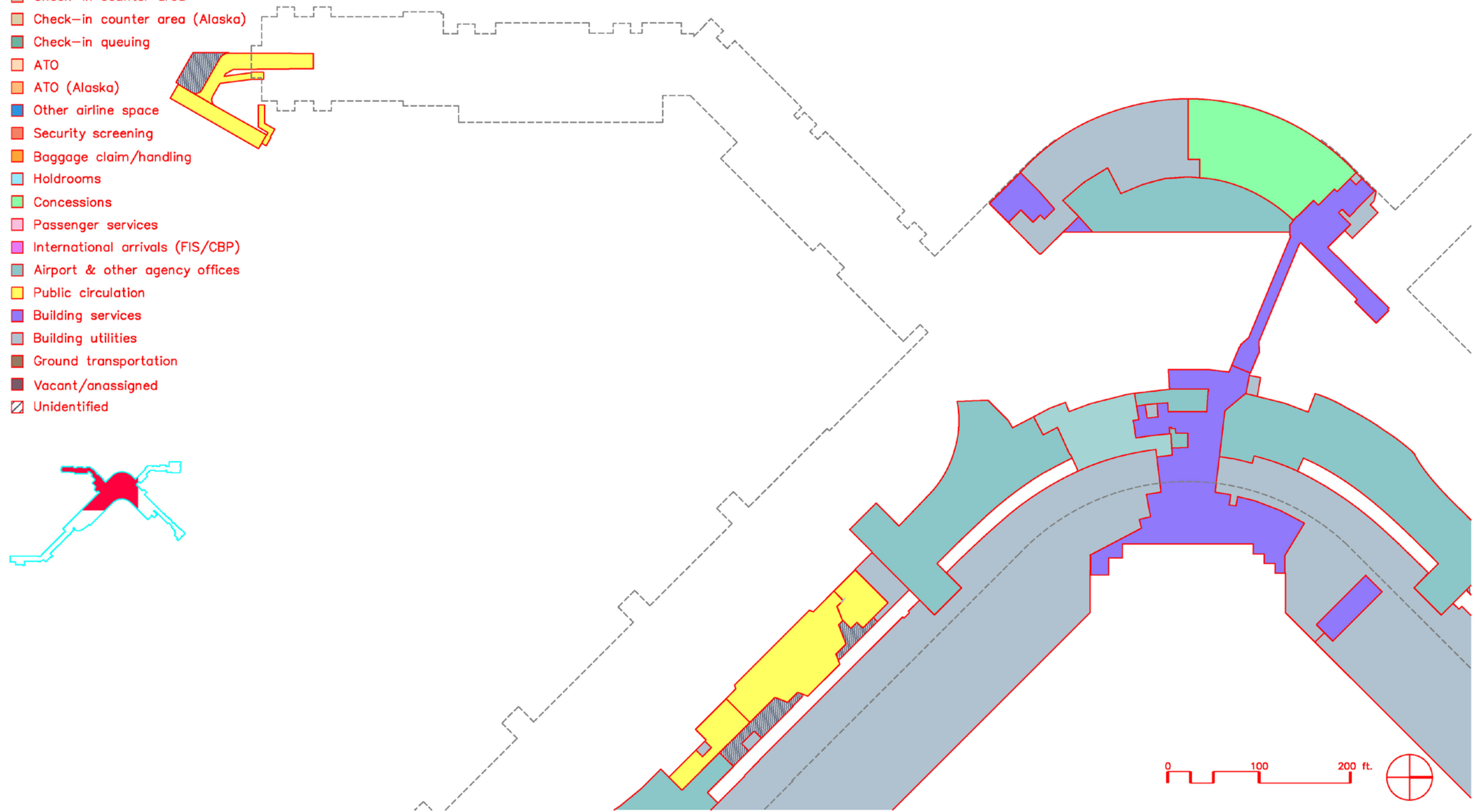


Source: 2014 POS AutoCAD base files and terminal space allocations

Figure 3-8  
**Overall Terminal Functional Allocation – STS Level Area 2**  
 Seattle-Tacoma International Airport

LEGEND

- Check-in counter area
- Check-in counter area (Alaska)
- Check-in queuing
- ATO
- ATO (Alaska)
- Other airline space
- Security screening
- Baggage claim/handling
- Holdrooms
- Concessions
- Passenger services
- International arrivals (FIS/CBP)
- Airport & other agency offices
- Public circulation
- Building services
- Building utilities
- Ground transportation
- Vacant/anassigned
- Unidentified

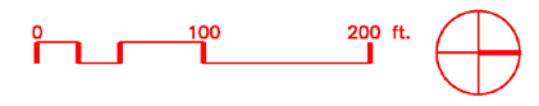
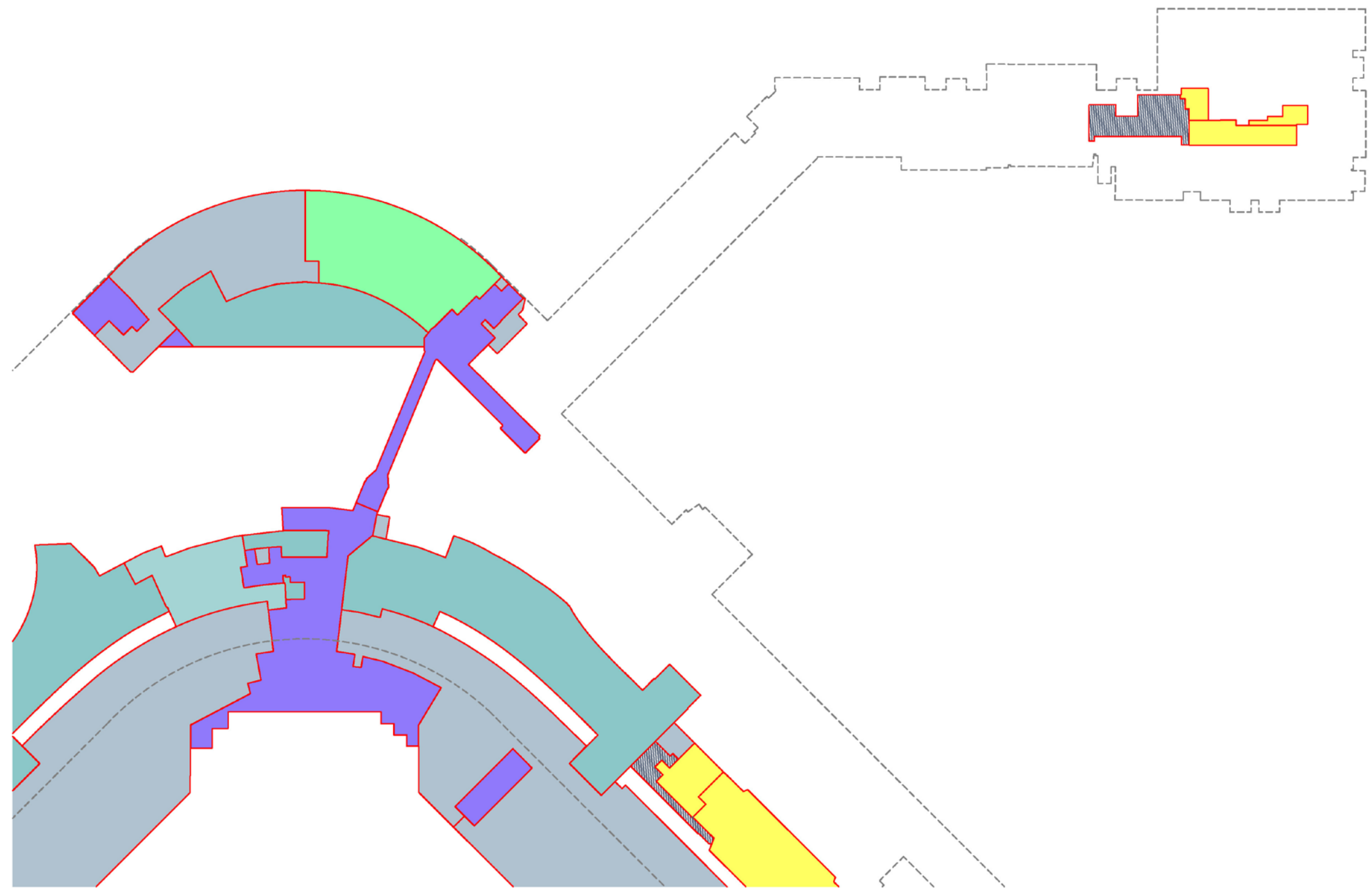
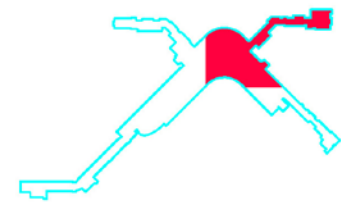


Source: 2014 POS AutoCAD base files and terminal space allocations

Figure 3-9  
**Overall Terminal Functional Allocation – STS Level Area 3**  
 Seattle-Tacoma International Airport

**LEGEND**

- Check-in counter area
- Check-in counter area (Alaska)
- Check-in queuing
- ATO
- ATO (Alaska)
- Other airline space
- Security screening
- Baggage claim/handling
- Holdrooms
- Concessions
- Passenger services
- International arrivals (FIS/CBP)
- Airport & other agency offices
- Public circulation
- Building services
- Building utilities
- Ground transportation
- Vacant/anassigned
- Unidentified

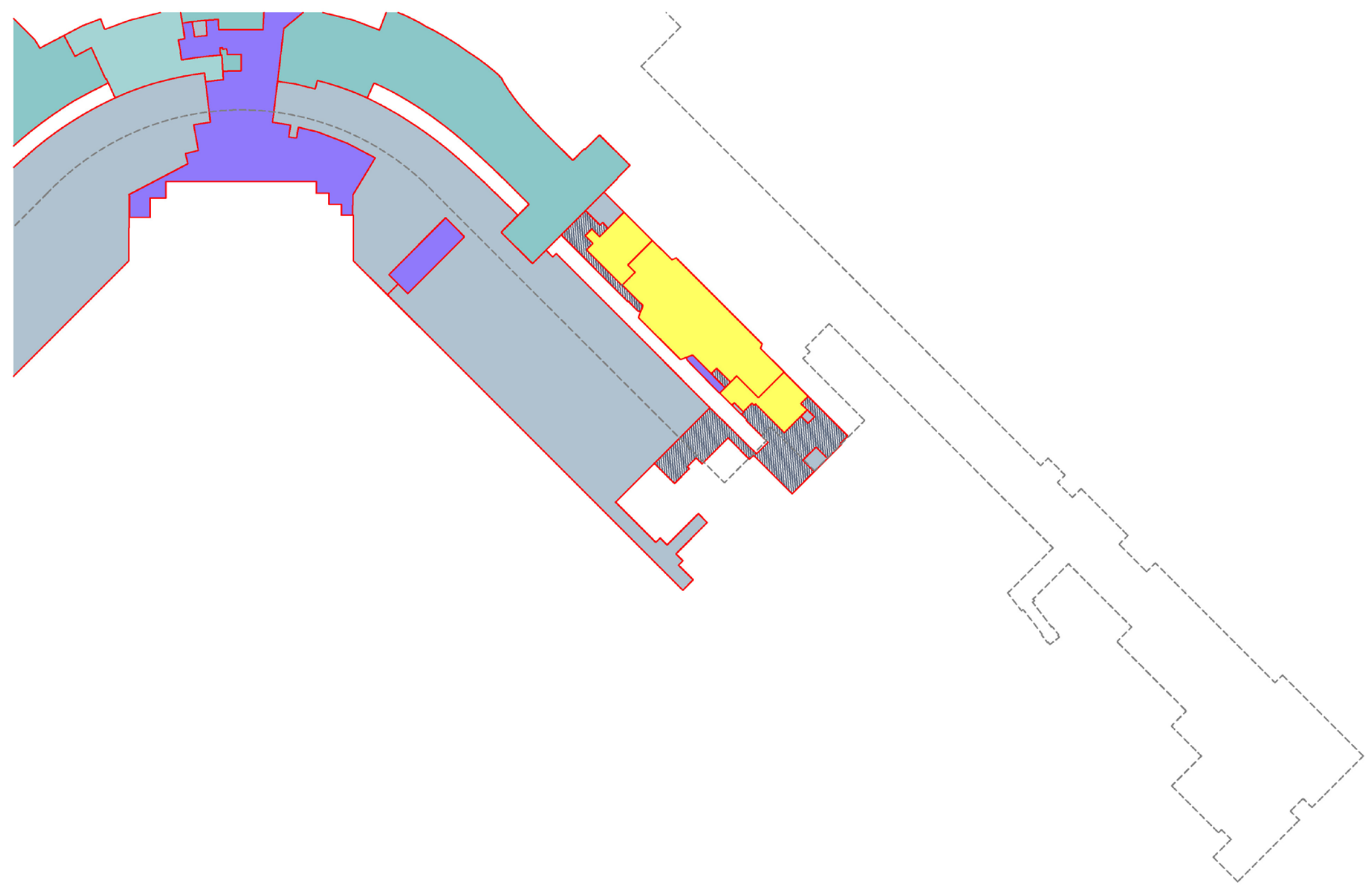


Source: 2014 POS AutoCAD base files and terminal space allocations



Figure 3-10  
**Overall Terminal Functional Allocation – STS Level Area 4**  
 Seattle-Tacoma International Airport

- LEGEND**
- Check-in counter area
  - Check-in counter area (Alaska)
  - Check-in queuing
  - ATO
  - ATO (Alaska)
  - Other airline space
  - Security screening
  - Baggage claim/handling
  - Holdrooms
  - Concessions
  - Passenger services
  - International arrivals (FIS/CBP)
  - Airport & other agency offices
  - Public circulation
  - Building services
  - Building utilities
  - Ground transportation
  - Vacant/anassigned
  - Unidentified

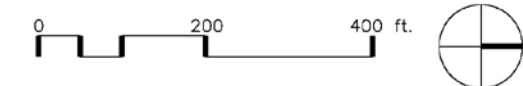
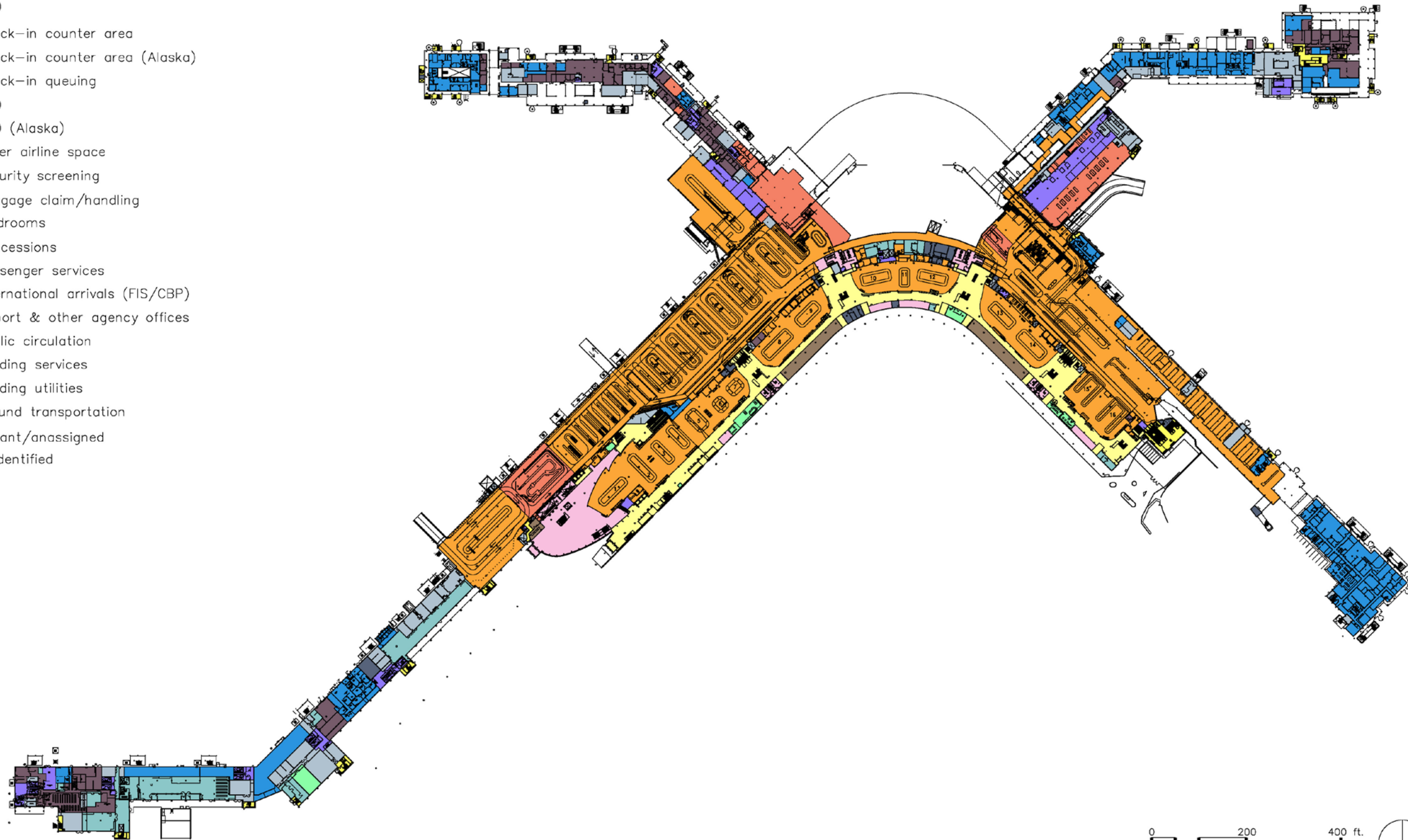


Source: 2014 POS AutoCAD base files and terminal space allocations

Figure 3-11  
**Overall Terminal Functional Allocation – Baggage Level**  
 Seattle-Tacoma International Airport

LEGEND

- Check-in counter area
- Check-in counter area (Alaska)
- Check-in queuing
- ATO
- ATO (Alaska)
- Other airline space
- Security screening
- Baggage claim/handling
- Holdrooms
- Concessions
- Passenger services
- International arrivals (FIS/CBP)
- Airport & other agency offices
- Public circulation
- Building services
- Building utilities
- Ground transportation
- Vacant/anassigned
- Unidentified

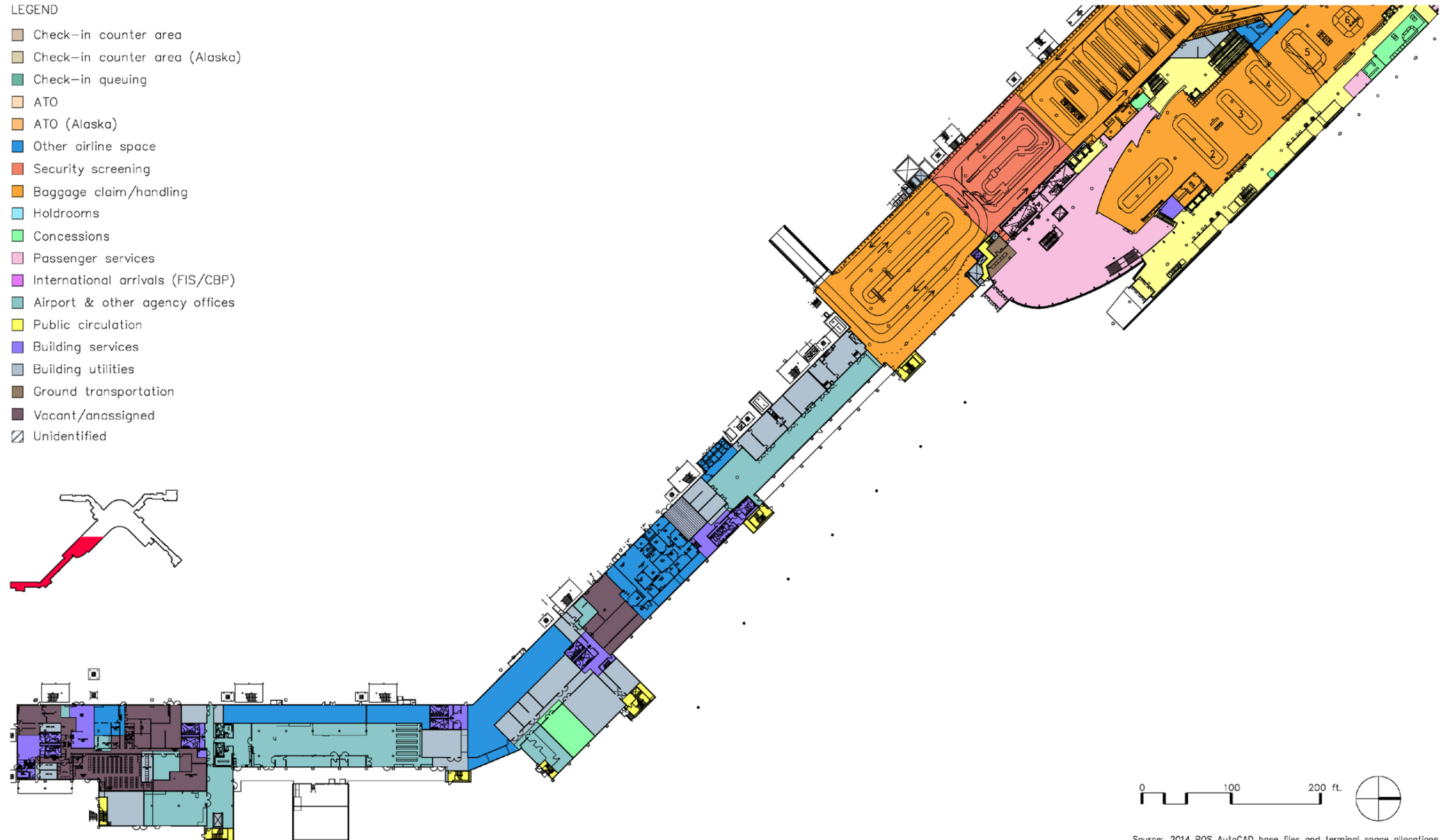


Source: 2014 POS AutoCAD base files and terminal space allocations

Figure 3-12  
**Overall Terminal Functional Allocation – Baggage Level Area 1**  
 Seattle-Tacoma International Airport

LEGEND

- Check-in counter area
- Check-in counter area (Alaska)
- Check-in queuing
- ATO
- ATO (Alaska)
- Other airline space
- Security screening
- Baggage claim/handling
- Holdrooms
- Concessions
- Passenger services
- International arrivals (FIS/CBP)
- Airport & other agency offices
- Public circulation
- Building services
- Building utilities
- Ground transportation
- Vacant/anassigned
- Unidentified

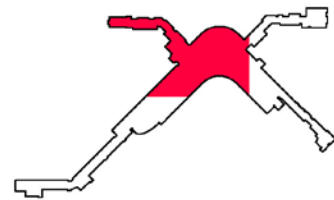


Source: 2014 POS AutoCAD base files and terminal space allocations

Figure 3-13  
**Overall Terminal Functional Allocation – Baggage Level Area 2**  
 Seattle-Tacoma International Airport

LEGEND

- Check-in counter area
- Check-in counter area (Alaska)
- Check-in queuing
- ATO
- ATO (Alaska)
- Other airline space
- Security screening
- Baggage claim/handling
- Holdrooms
- Concessions
- Passenger services
- International arrivals (FIS/CBP)
- Airport & other agency offices
- Public circulation
- Building services
- Building utilities
- Ground transportation
- Vacant/anassigned
- Unidentified

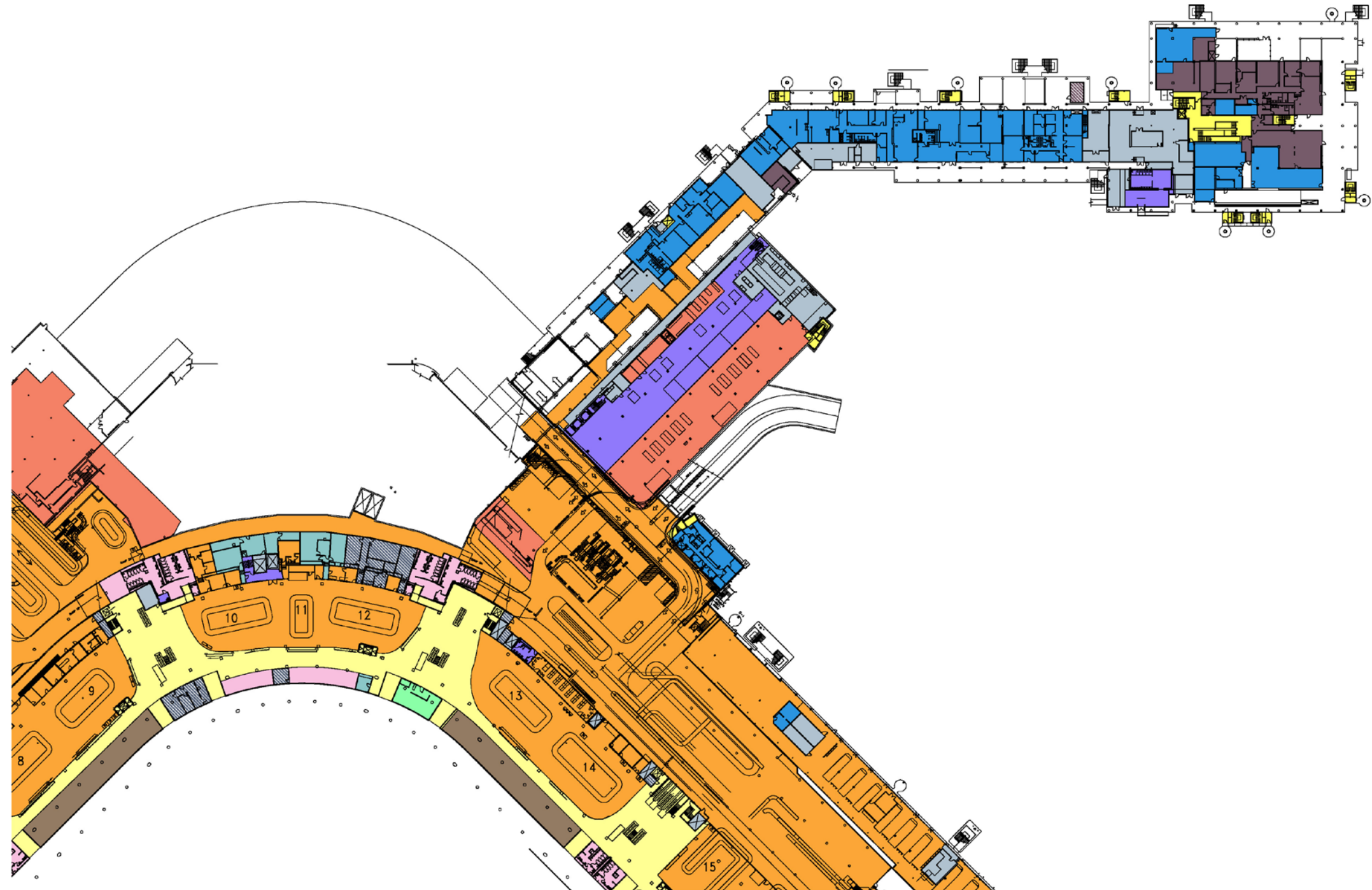
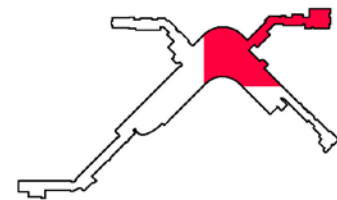


Source: 2014 PCS AutoCAD base files and terminal space allocations

Figure 3-14  
**Overall Terminal Functional Allocation – Baggage Level Area 3**  
 Seattle-Tacoma International Airport

LEGEND

- Check-in counter area
- Check-in counter area (Alaska)
- Check-in queuing
- ATO
- ATO (Alaska)
- Other airline space
- Security screening
- Baggage claim/handling
- Holdrooms
- Concessions
- Passenger services
- International arrivals (FIS/CBP)
- Airport & other agency offices
- Public circulation
- Building services
- Building utilities
- Ground transportation
- Vacant/unassigned
- Unidentified

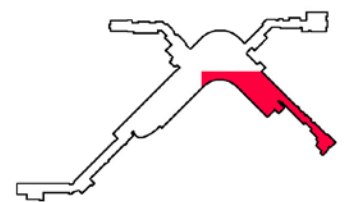


Source: 2014 POS AutoCAD base files and terminal space allocations

Figure 3-15  
**Overall Terminal Functional Allocation – Baggage Level Area 4**  
 Seattle-Tacoma International Airport

LEGEND

- Check-in counter area
- Check-in counter area (Alaska)
- Check-in queuing
- ATO
- ATO (Alaska)
- Other airline space
- Security screening
- Baggage claim/handling
- Holdrooms
- Concessions
- Passenger services
- International arrivals (FIS/CBP)
- Airport & other agency offices
- Public circulation
- Building services
- Building utilities
- Ground transportation
- Vacant/anassigned
- Unidentified

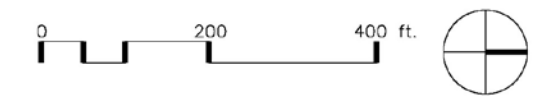
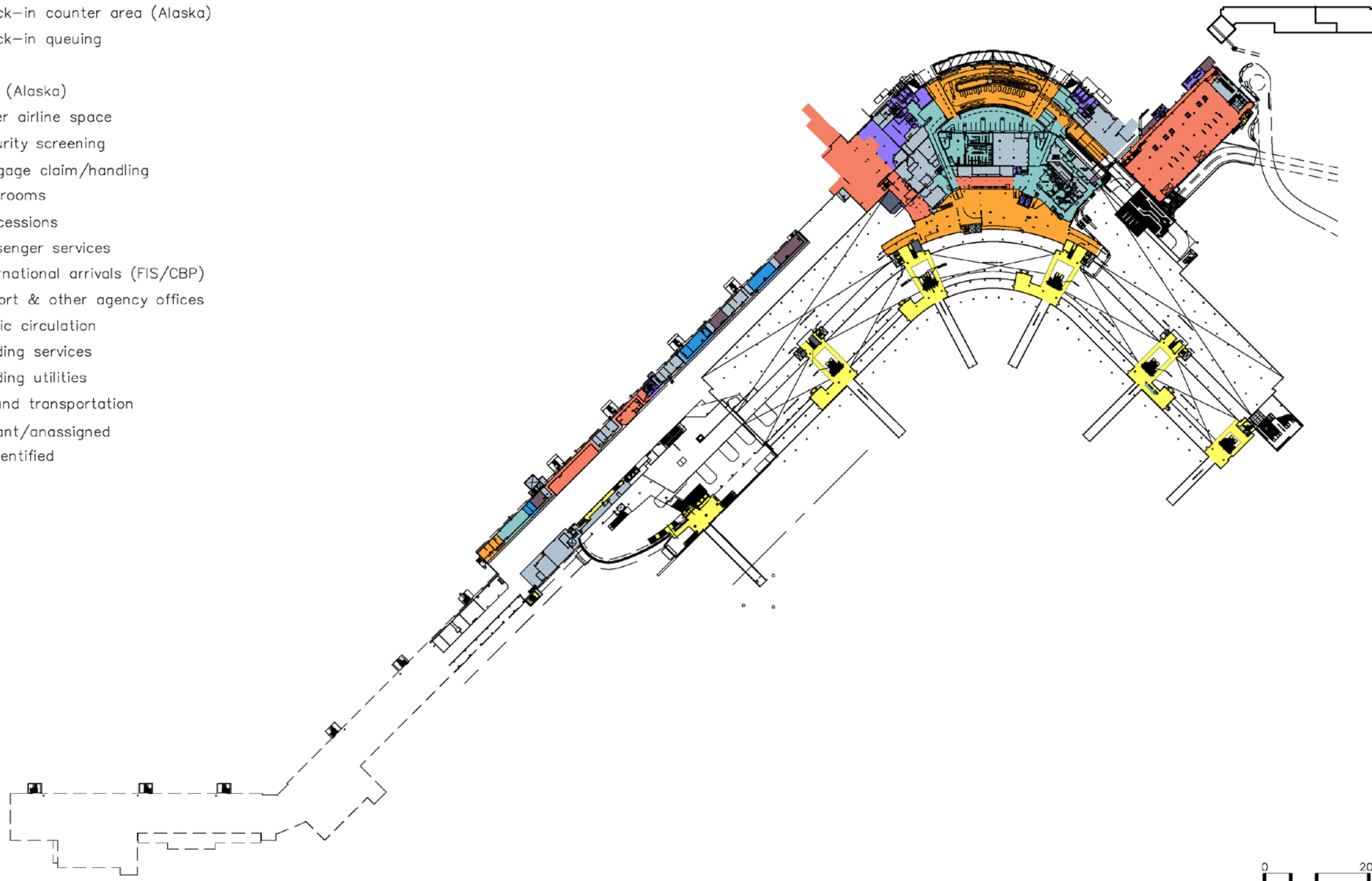


Source: 2014 POS AutoCAD base files and terminal space allocations

Figure 3-16  
**Overall Terminal Functional Allocation – Bridge Level**  
 Seattle-Tacoma International Airport

LEGEND

- Check-in counter area
- Check-in counter area (Alaska)
- Check-in queuing
- ATO
- ATO (Alaska)
- Other airline space
- Security screening
- Baggage claim/handling
- Holdrooms
- Concessions
- Passenger services
- International arrivals (FIS/CBP)
- Airport & other agency offices
- Public circulation
- Building services
- Building utilities
- Ground transportation
- Vacant/anassigned
- Unidentified

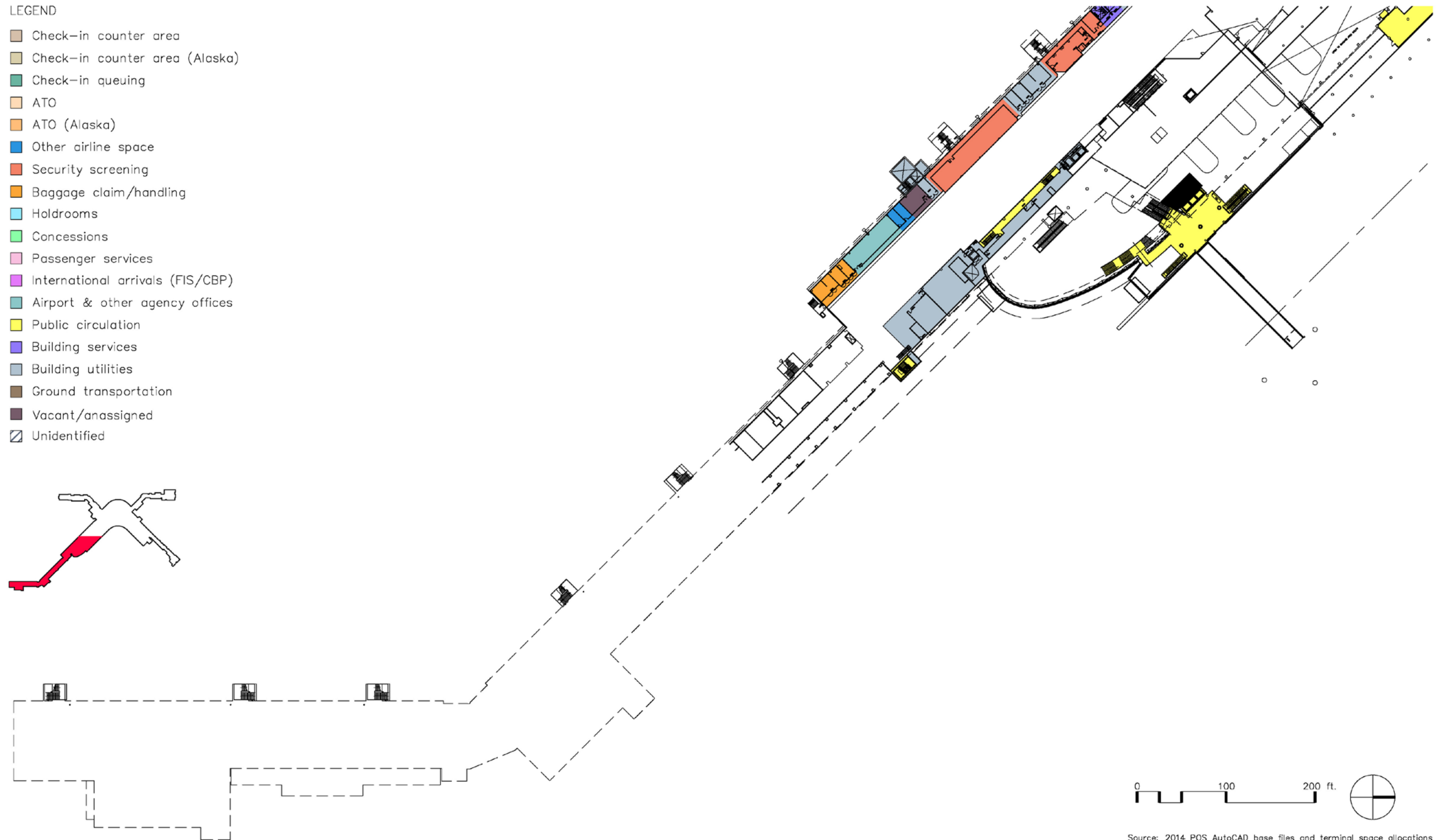


Source: 2014 POS AutoCAD base files and terminal space allocations

Figure 3-17  
**Overall Terminal Functional Allocation – Bridge Level Area 1**  
 Seattle-Tacoma International Airport

LEGEND

- Check-in counter area
- Check-in counter area (Alaska)
- Check-in queuing
- ATO
- ATO (Alaska)
- Other airline space
- Security screening
- Baggage claim/handling
- Holdrooms
- Concessions
- Passenger services
- International arrivals (FIS/CBP)
- Airport & other agency offices
- Public circulation
- Building services
- Building utilities
- Ground transportation
- Vacant/anassigned
- Unidentified



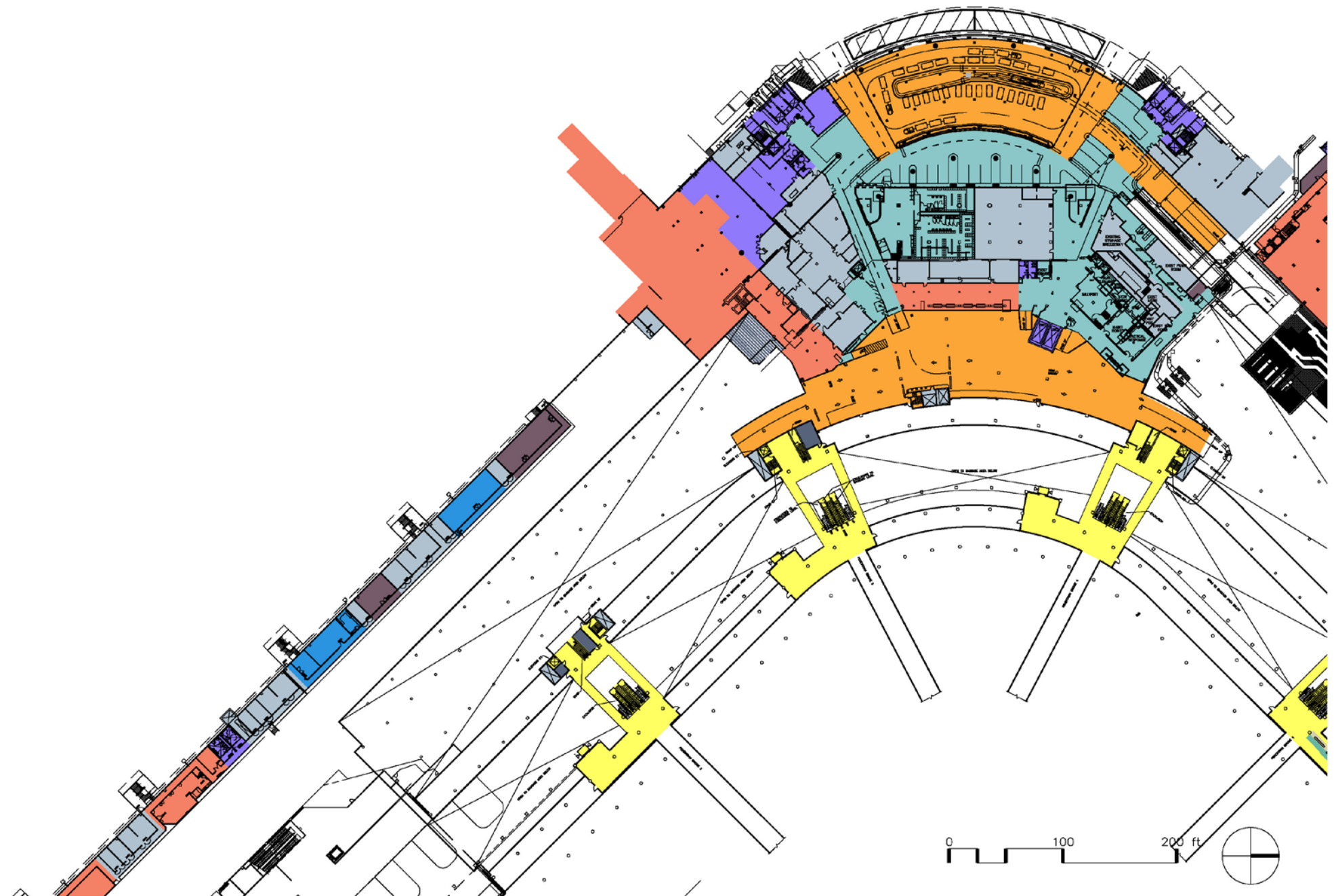
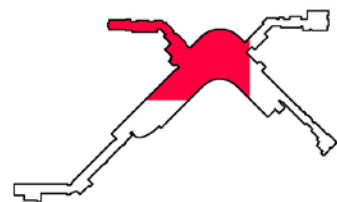
Source: 2014 POS AutoCAD base files and terminal space allocations



Figure 3-18  
**Overall Terminal Functional Allocation – Bridge Level Area 2**  
 Seattle-Tacoma International Airport

LEGEND

- Check-in counter area
- Check-in counter area (Alaska)
- Check-in queuing
- ATO
- ATO (Alaska)
- Other airline space
- Security screening
- Baggage claim/handling
- Holdrooms
- Concessions
- Passenger services
- International arrivals (FIS/CBP)
- Airport & other agency offices
- Public circulation
- Building services
- Building utilities
- Ground transportation
- Vacant/anassigned
- Unidentified

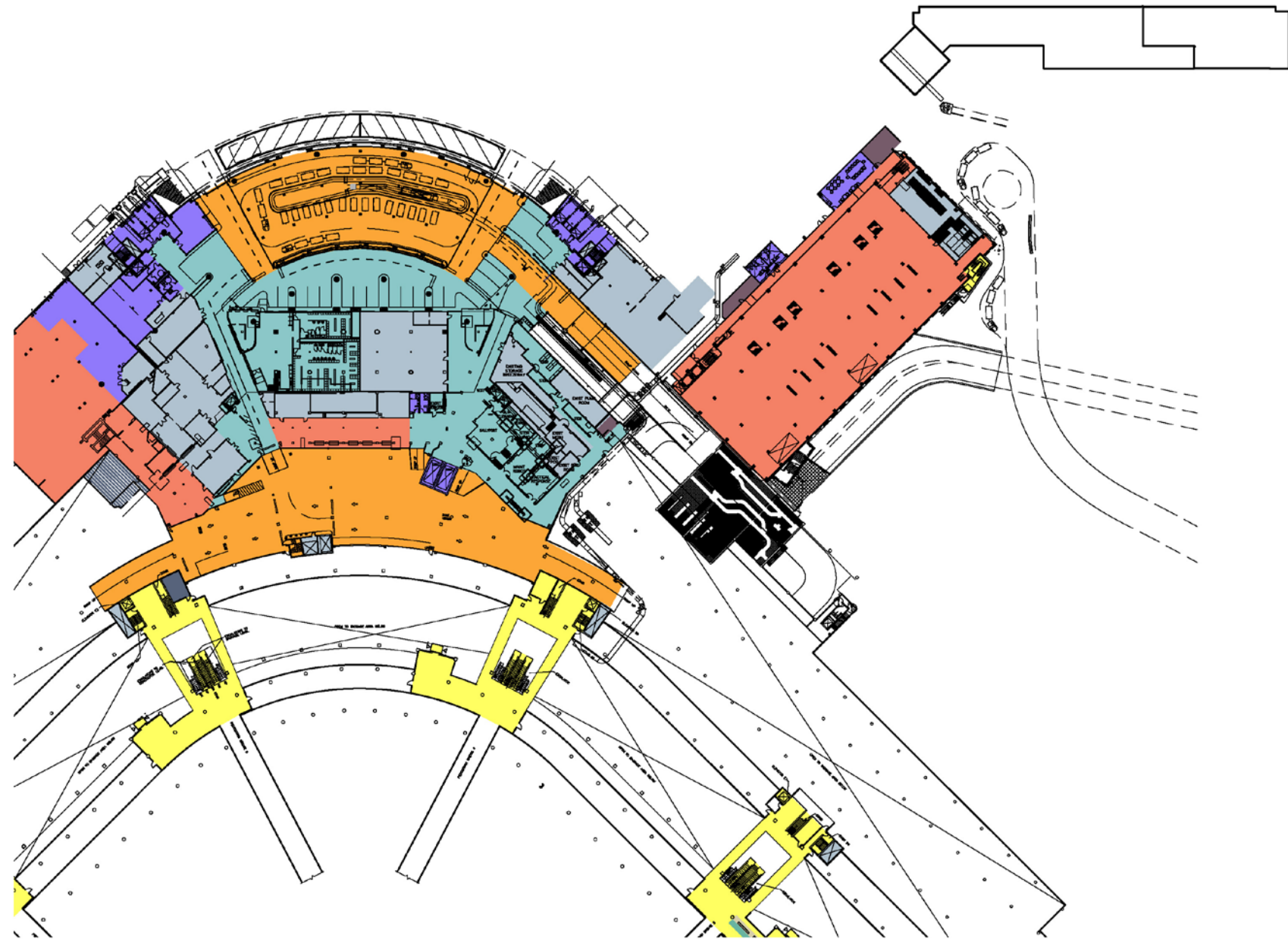
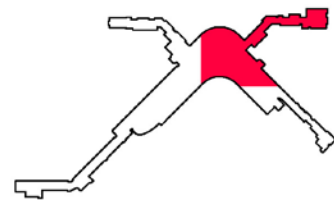


Source: 2014 POS AutoCAD base files and terminal space allocations

Figure 3-19  
**Overall Terminal Functional Allocation – Bridge Level Area 3**  
 Seattle-Tacoma International Airport

LEGEND

- Check-in counter area
- Check-in counter area (Alaska)
- Check-in queuing
- ATO
- ATO (Alaska)
- Other airline space
- Security screening
- Baggage claim/handling
- Holdrooms
- Concessions
- Passenger services
- International arrivals (FIS/CBP)
- Airport & other agency offices
- Public circulation
- Building services
- Building utilities
- Ground transportation
- Vacant/unassigned
- Unidentified

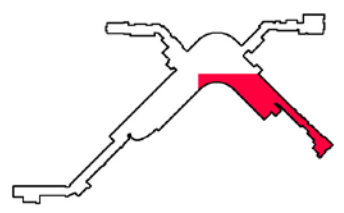
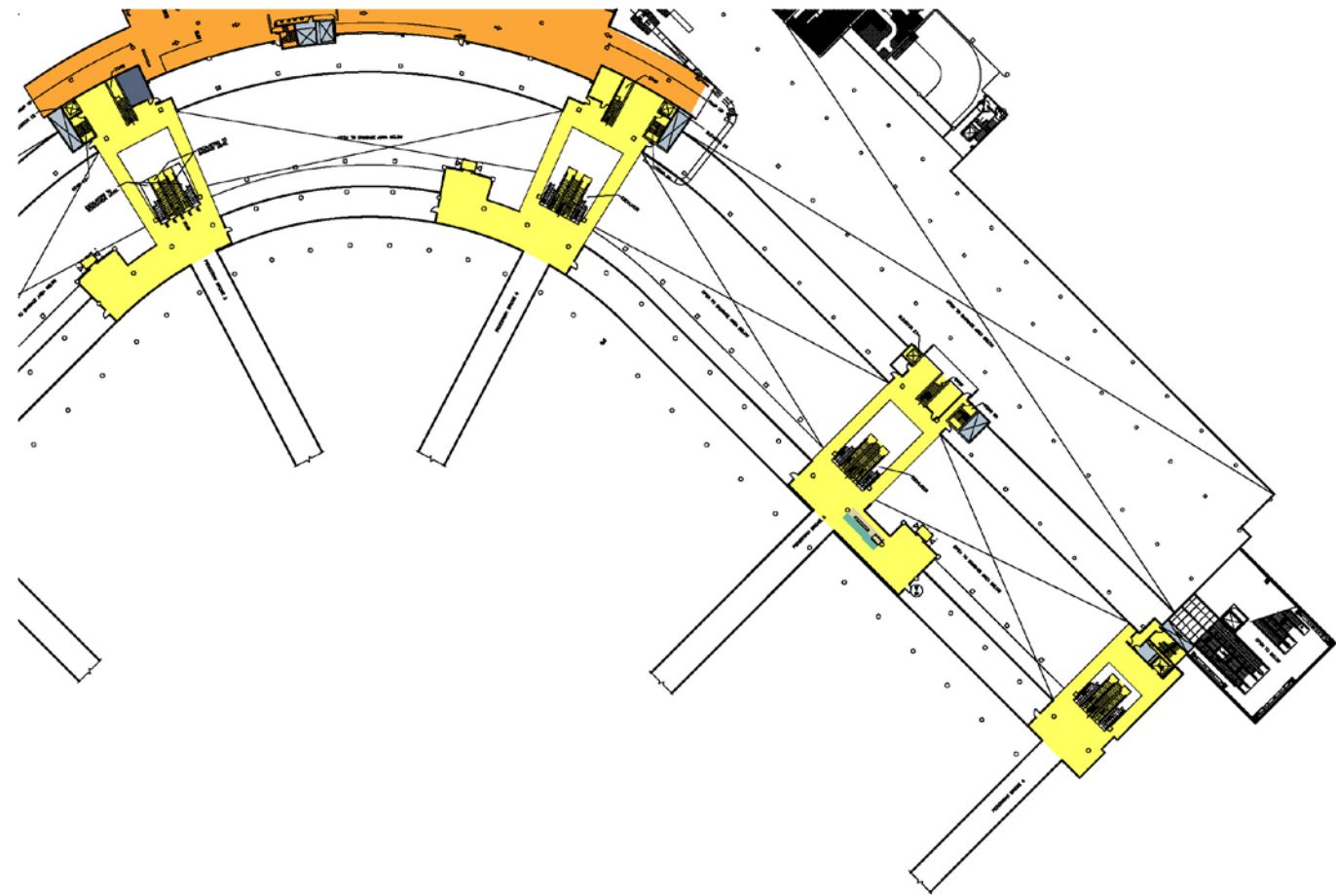


Source: 2014 POS AutoCAD base files and terminal space allocations

Figure 3-20  
**Overall Terminal Functional Allocation – Bridge Level Area 4**  
 Seattle-Tacoma International Airport

LEGEND

- Check-in counter area
- Check-in counter area (Alaska)
- Check-in queuing
- ATO
- ATO (Alaska)
- Other airline space
- Security screening
- Baggage claim/handling
- Holdrooms
- Concessions
- Passenger services
- International arrivals (FIS/CBP)
- Airport & other agency offices
- Public circulation
- Building services
- Building utilities
- Ground transportation
- Vacant/anassigned
- Unidentified

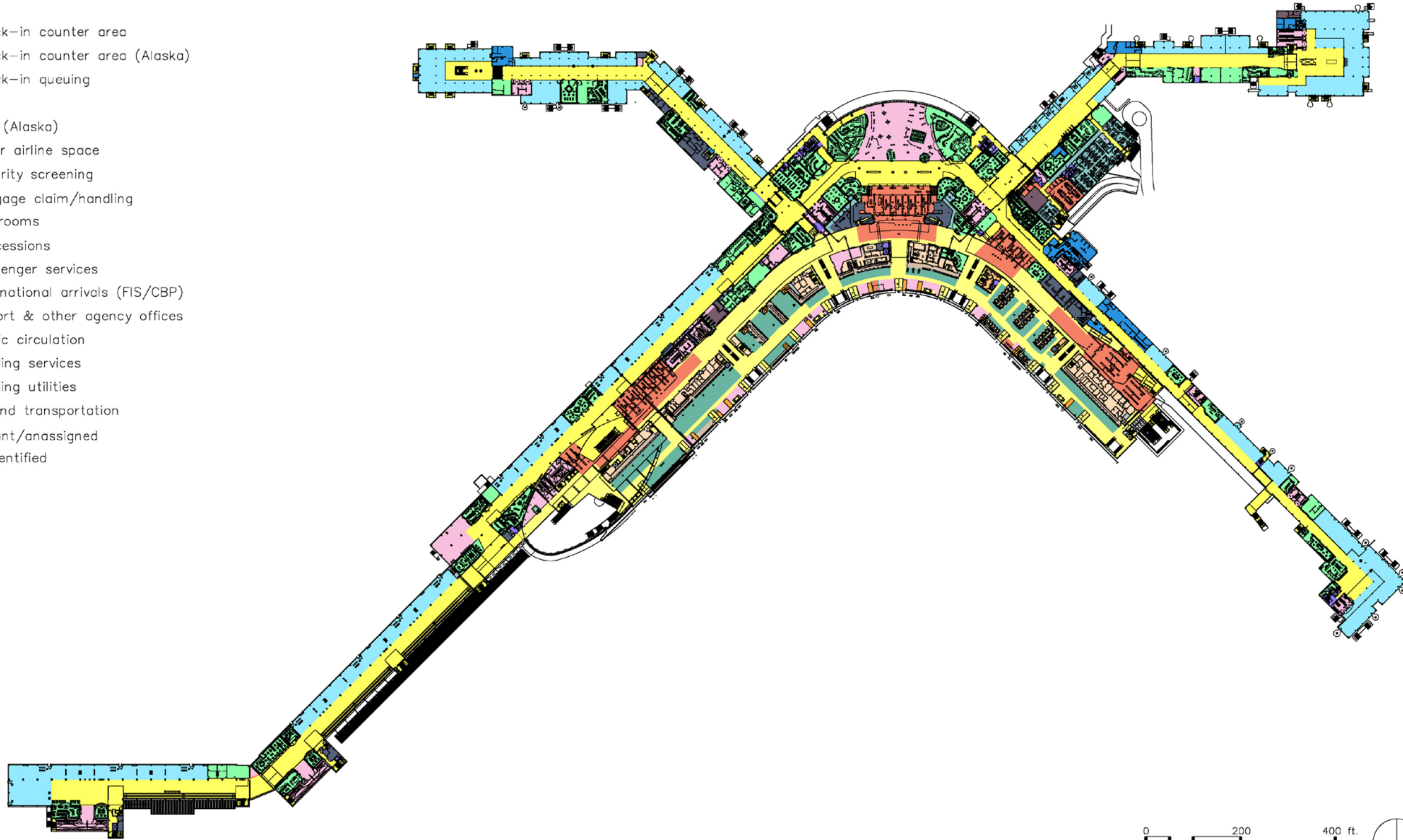


Source: 2014 POS AutoCAD base files and terminal space allocations

Figure 3-21  
**Overall Terminal Functional Allocation – Concourse Level**  
 Seattle-Tacoma International Airport

LEGEND

- Check-in counter area
- Check-in counter area (Alaska)
- Check-in queuing
- ATO
- ATO (Alaska)
- Other airline space
- Security screening
- Baggage claim/handling
- Holdrooms
- Concessions
- Passenger services
- International arrivals (FIS/CBP)
- Airport & other agency offices
- Public circulation
- Building services
- Building utilities
- Ground transportation
- Vacant/anassigned
- Unidentified

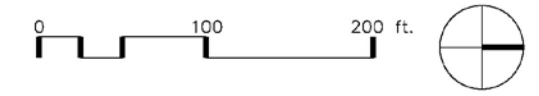
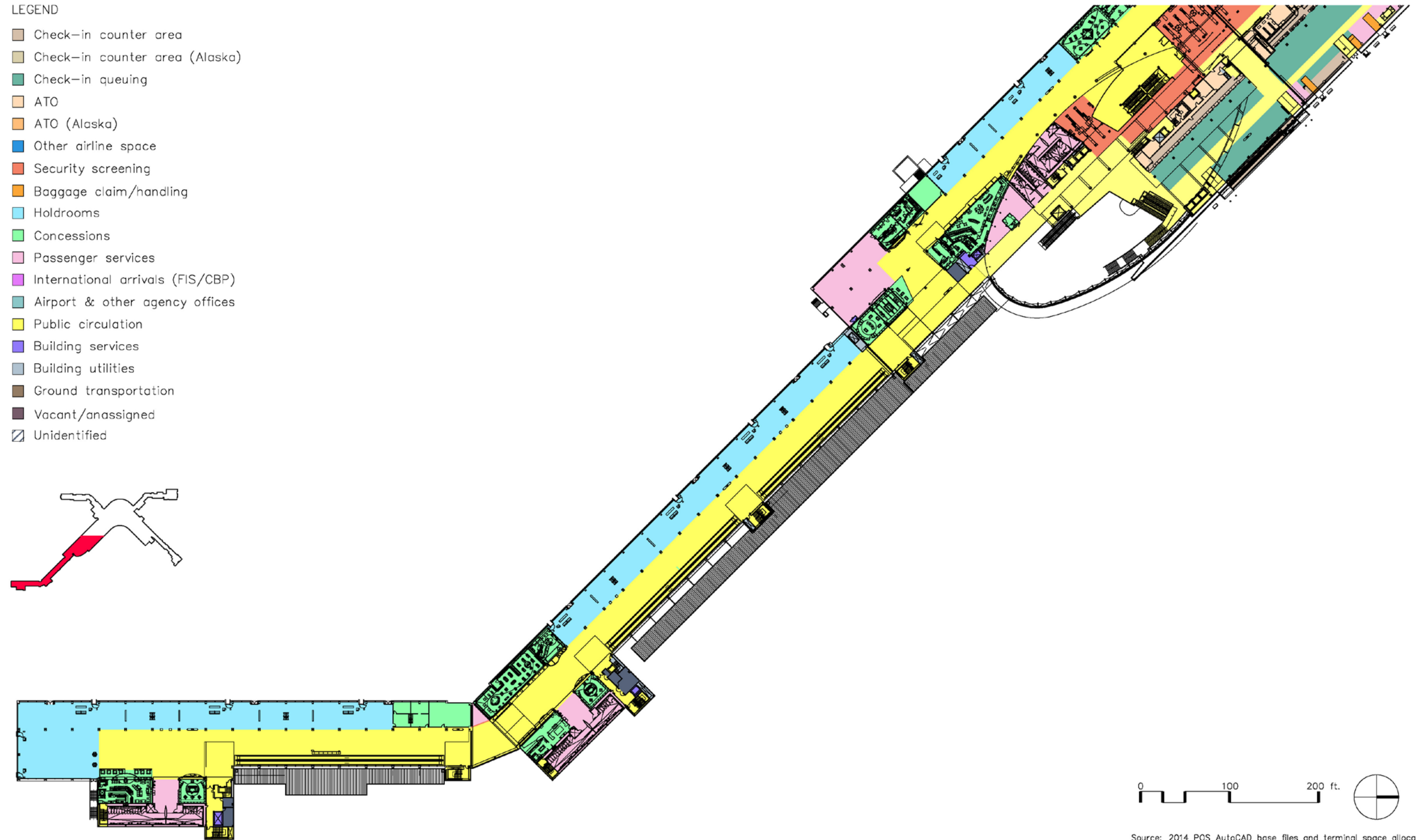


Source: 2014 POS AutoCAD base files and terminal space allocations

Figure 3-22  
**Overall Terminal Functional Allocation – Concourse Level Area 1**  
 Seattle-Tacoma International Airport

LEGEND

- Check-in counter area
- Check-in counter area (Alaska)
- Check-in queuing
- ATO
- ATO (Alaska)
- Other airline space
- Security screening
- Baggage claim/handling
- Holdrooms
- Concessions
- Passenger services
- International arrivals (FIS/CBP)
- Airport & other agency offices
- Public circulation
- Building services
- Building utilities
- Ground transportation
- Vacant/anassigned
- Unidentified

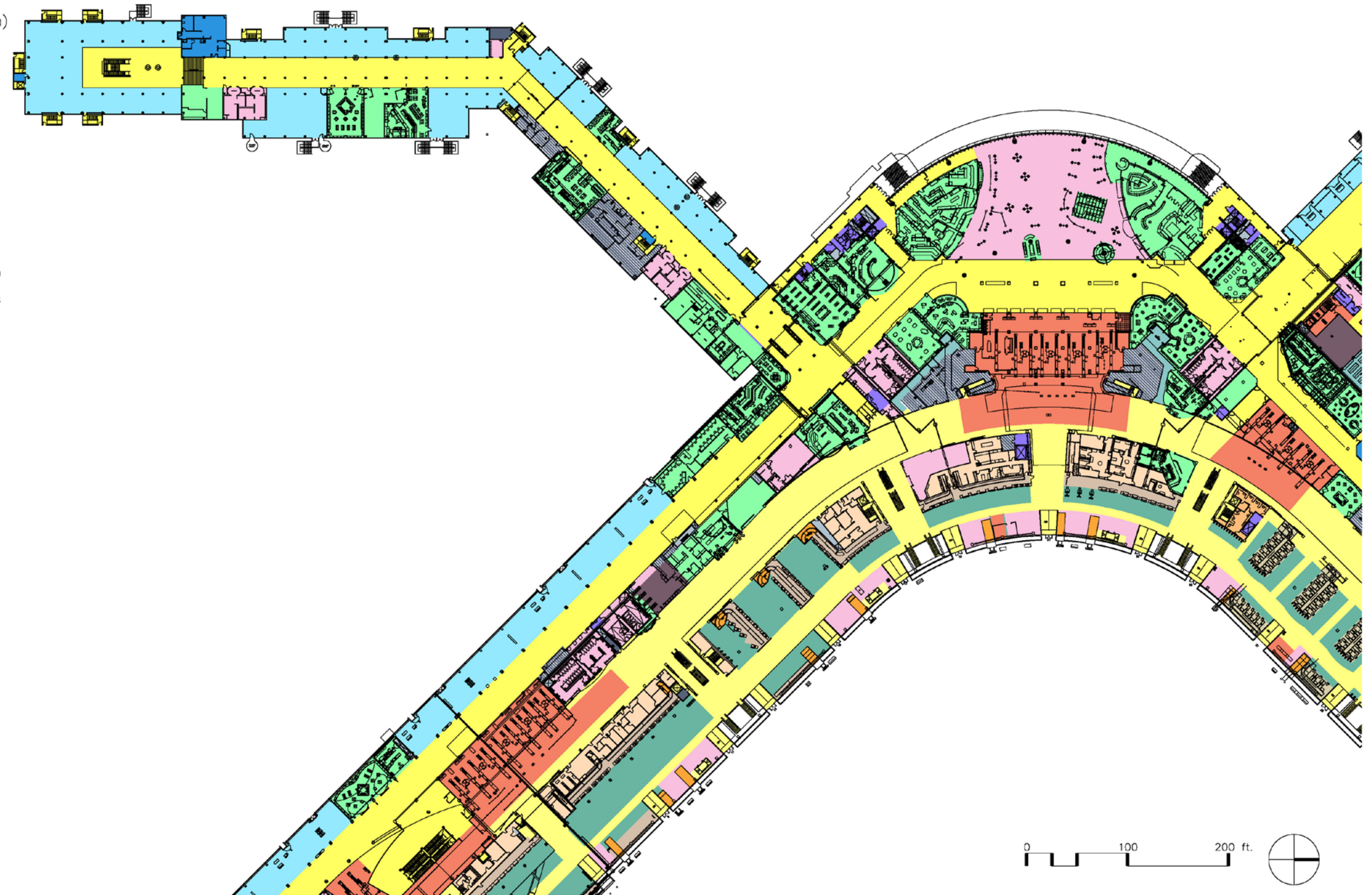


Source: 2014 PCS AutoCAD base files and terminal space allocations

Figure 3-23  
**Overall Terminal Functional Allocation – Concourse Level Area 2**  
 Seattle-Tacoma International Airport

LEGEND

- Check-in counter area
- Check-in counter area (Alaska)
- Check-in queuing
- ATO
- ATO (Alaska)
- Other airline space
- Security screening
- Baggage claim/handling
- Holdrooms
- Concessions
- Passenger services
- International arrivals (FIS/CBP)
- Airport & other agency offices
- Public circulation
- Building services
- Building utilities
- Ground transportation
- Vacant/anassigned
- Unidentified

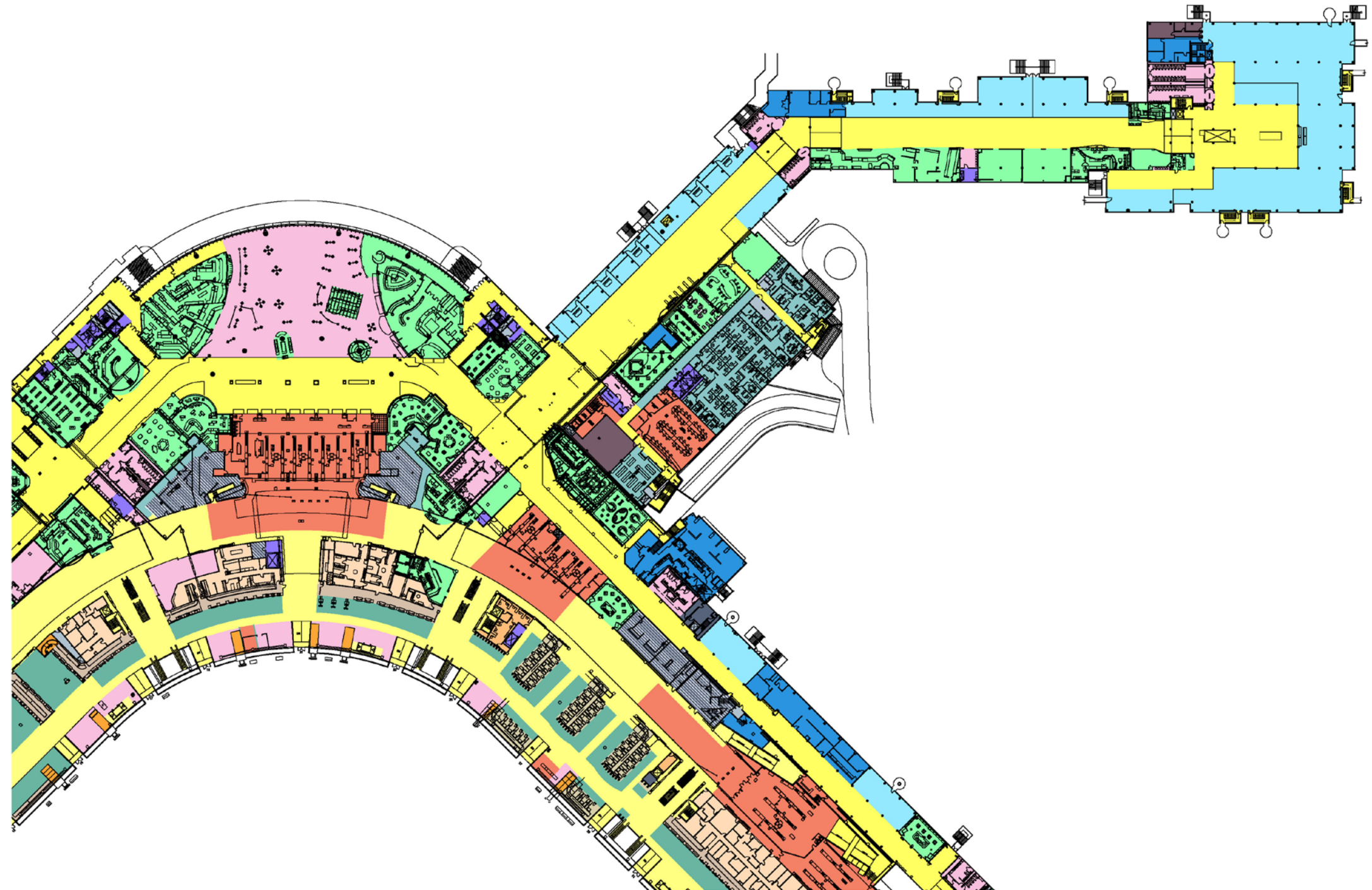
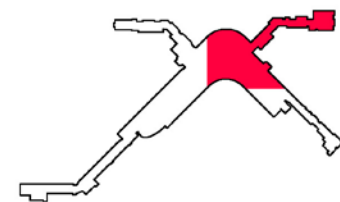


Source: 2014 POS AutoCAD base files and terminal space allocations

Figure 3-24  
**Overall Terminal Functional Allocation – Concourse Level Area 3**  
 Seattle-Tacoma International Airport

LEGEND

- Check-in counter area
- Check-in counter area (Alaska)
- Check-in queuing
- ATO
- ATO (Alaska)
- Other airline space
- Security screening
- Baggage claim/handling
- Holdrooms
- Concessions
- Passenger services
- International arrivals (FIS/CBP)
- Airport & other agency offices
- Public circulation
- Building services
- Building utilities
- Ground transportation
- Vacant/unassigned
- Unidentified

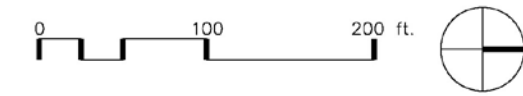
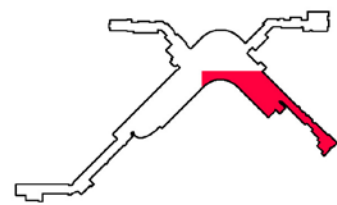
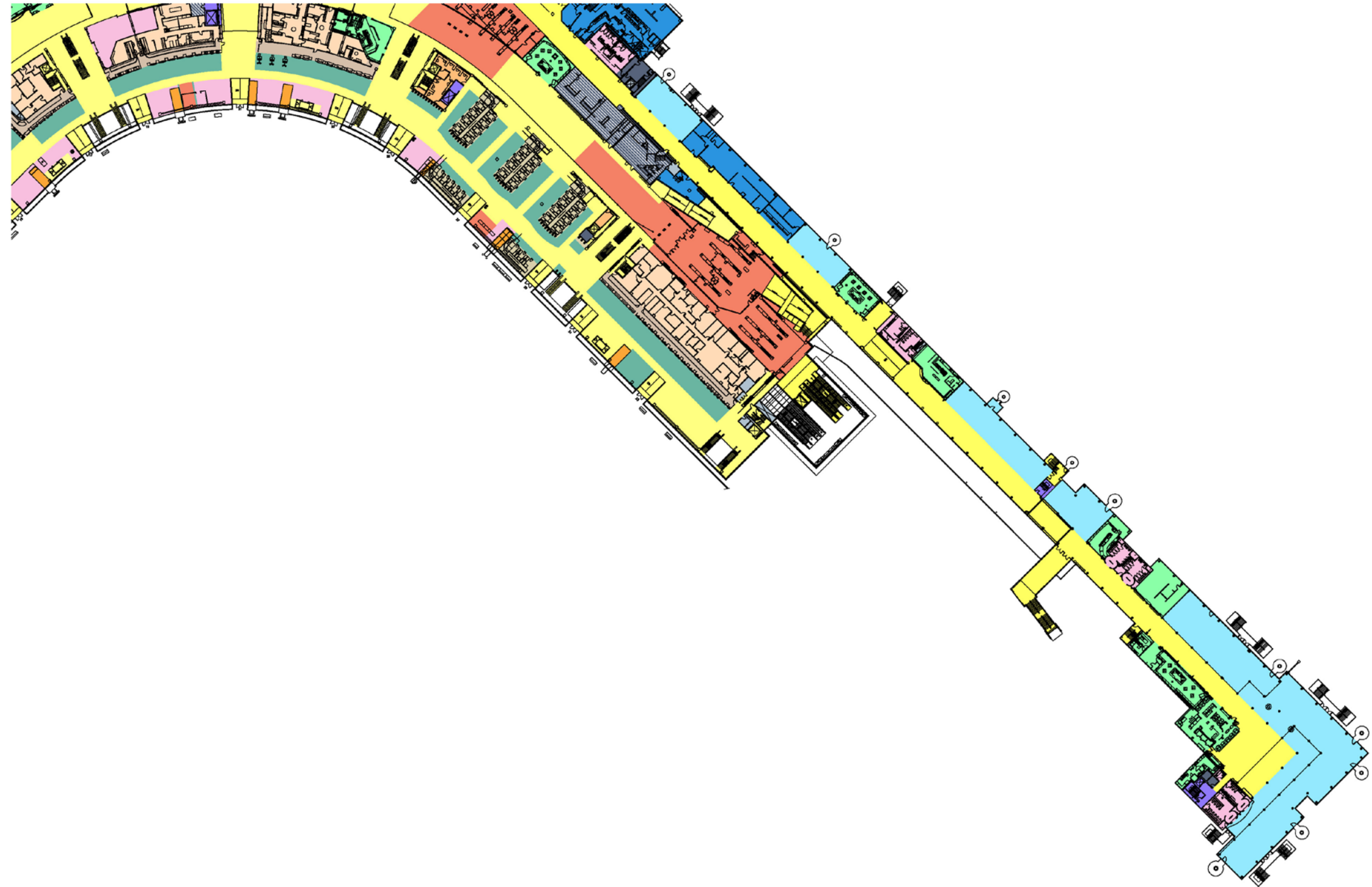


Source: 2014 POS AutoCAD base files and terminal space allocations

Figure 3-25  
**Overall Terminal Functional Allocation – Concourse Level Area 4**  
 Seattle-Tacoma International Airport

LEGEND

- Check-in counter area
- Check-in counter area (Alaska)
- Check-in queuing
- ATO
- ATO (Alaska)
- Other airline space
- Security screening
- Baggage claim/handling
- Holdrooms
- Concessions
- Passenger services
- International arrivals (FIS/CBP)
- Airport & other agency offices
- Public circulation
- Building services
- Building utilities
- Ground transportation
- Vacant/anassigned
- Unidentified

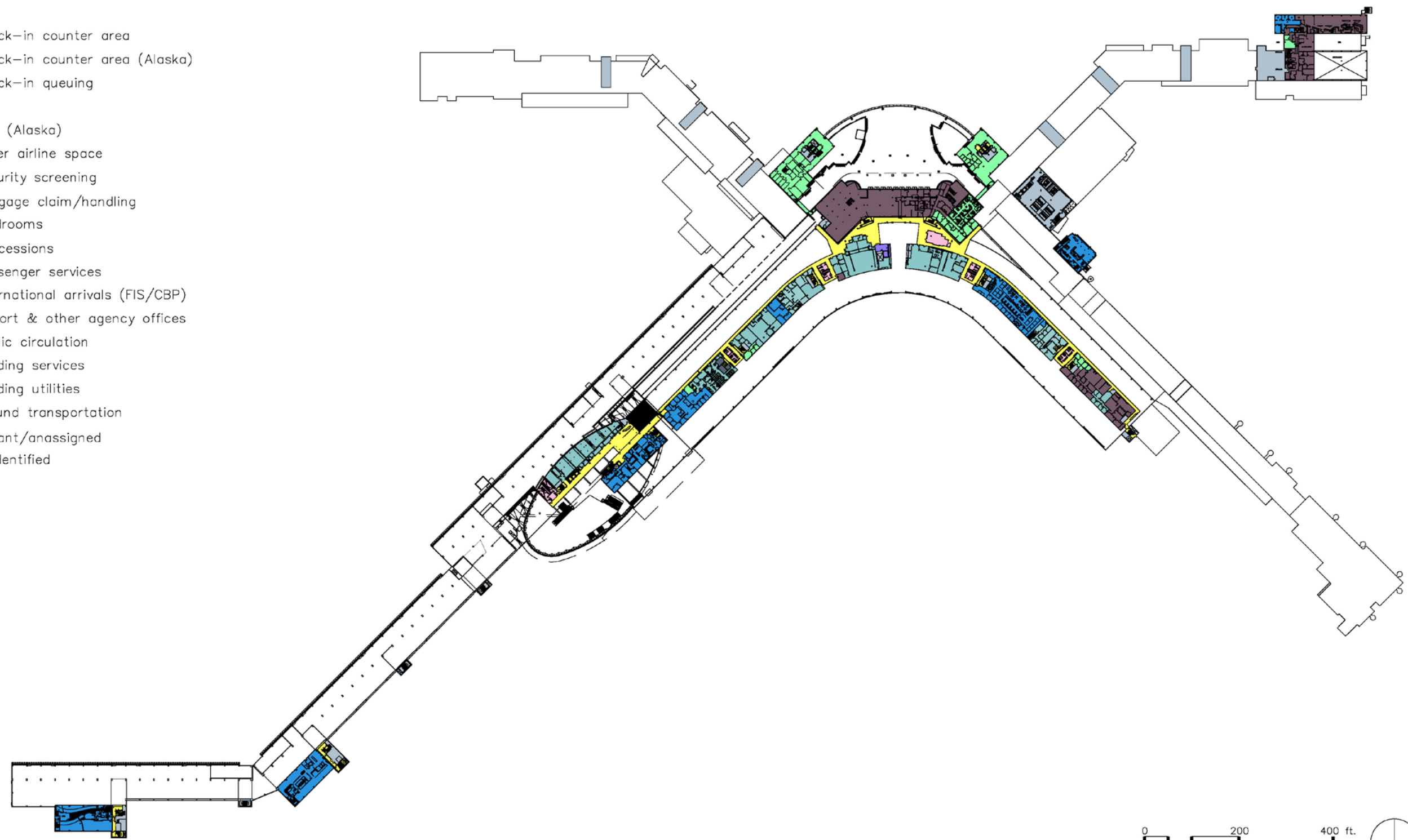


Source: 2014 PCS AutoCAD base files and terminal space allocations



Figure 3-26  
**Overall Terminal Functional Allocation – Mezzanine Level**  
 Seattle-Tacoma International Airport

- LEGEND
- Check-in counter area
  - Check-in counter area (Alaska)
  - Check-in queuing
  - ATO
  - ATO (Alaska)
  - Other airline space
  - Security screening
  - Baggage claim/handling
  - Holdrooms
  - Concessions
  - Passenger services
  - International arrivals (FIS/CBP)
  - Airport & other agency offices
  - Public circulation
  - Building services
  - Building utilities
  - Ground transportation
  - Vacant/anassigned
  - Unidentified

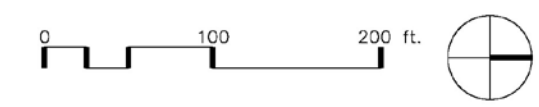
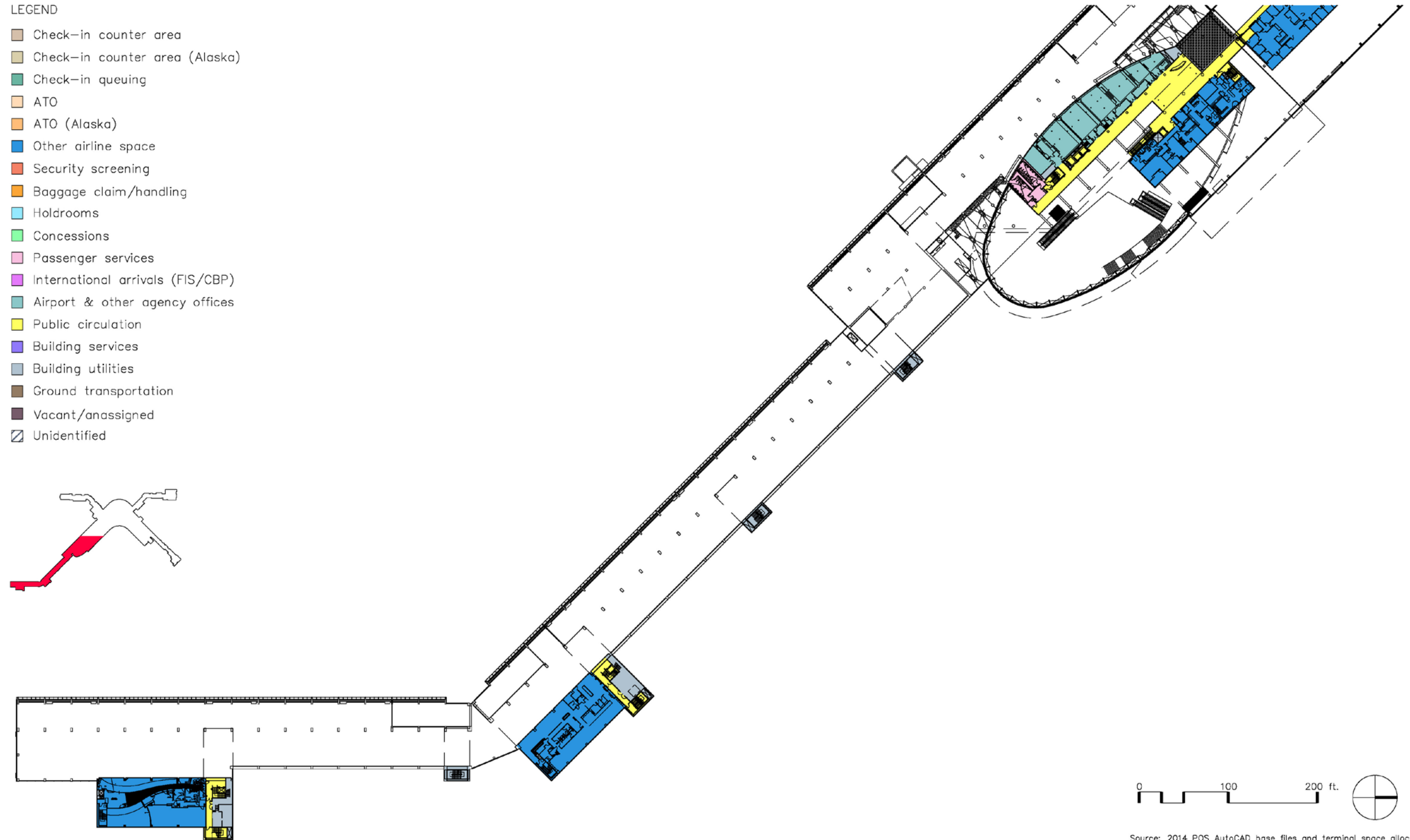


Source: 2014 POS AutoCAD base files and terminal space allocations

Figure 3-27  
**Overall Terminal Functional Allocation – Mezzanine Level Area 1**  
 Seattle-Tacoma International Airport

LEGEND

- Check-in counter area
- Check-in counter area (Alaska)
- Check-in queuing
- ATO
- ATO (Alaska)
- Other airline space
- Security screening
- Baggage claim/handling
- Holdrooms
- Concessions
- Passenger services
- International arrivals (FIS/CBP)
- Airport & other agency offices
- Public circulation
- Building services
- Building utilities
- Ground transportation
- Vacant/anassigned
- Unidentified

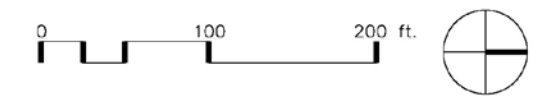
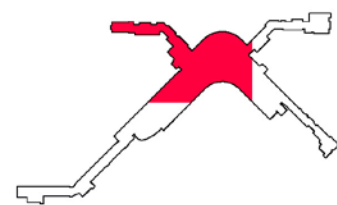


Source: 2014 POS AutoCAD base files and terminal space allocations

Figure 3-28  
**Overall Terminal Functional Allocation – Mezzanine Level Area 2**  
 Seattle-Tacoma International Airport

LEGEND

- Check-in counter area
- Check-in counter area (Alaska)
- Check-in queuing
- ATO
- ATO (Alaska)
- Other airline space
- Security screening
- Baggage claim/handling
- Holdrooms
- Concessions
- Passenger services
- International arrivals (FIS/CBP)
- Airport & other agency offices
- Public circulation
- Building services
- Building utilities
- Ground transportation
- Vacant/anassigned
- Unidentified

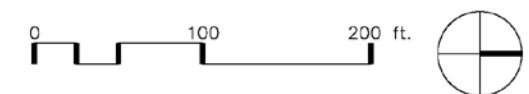
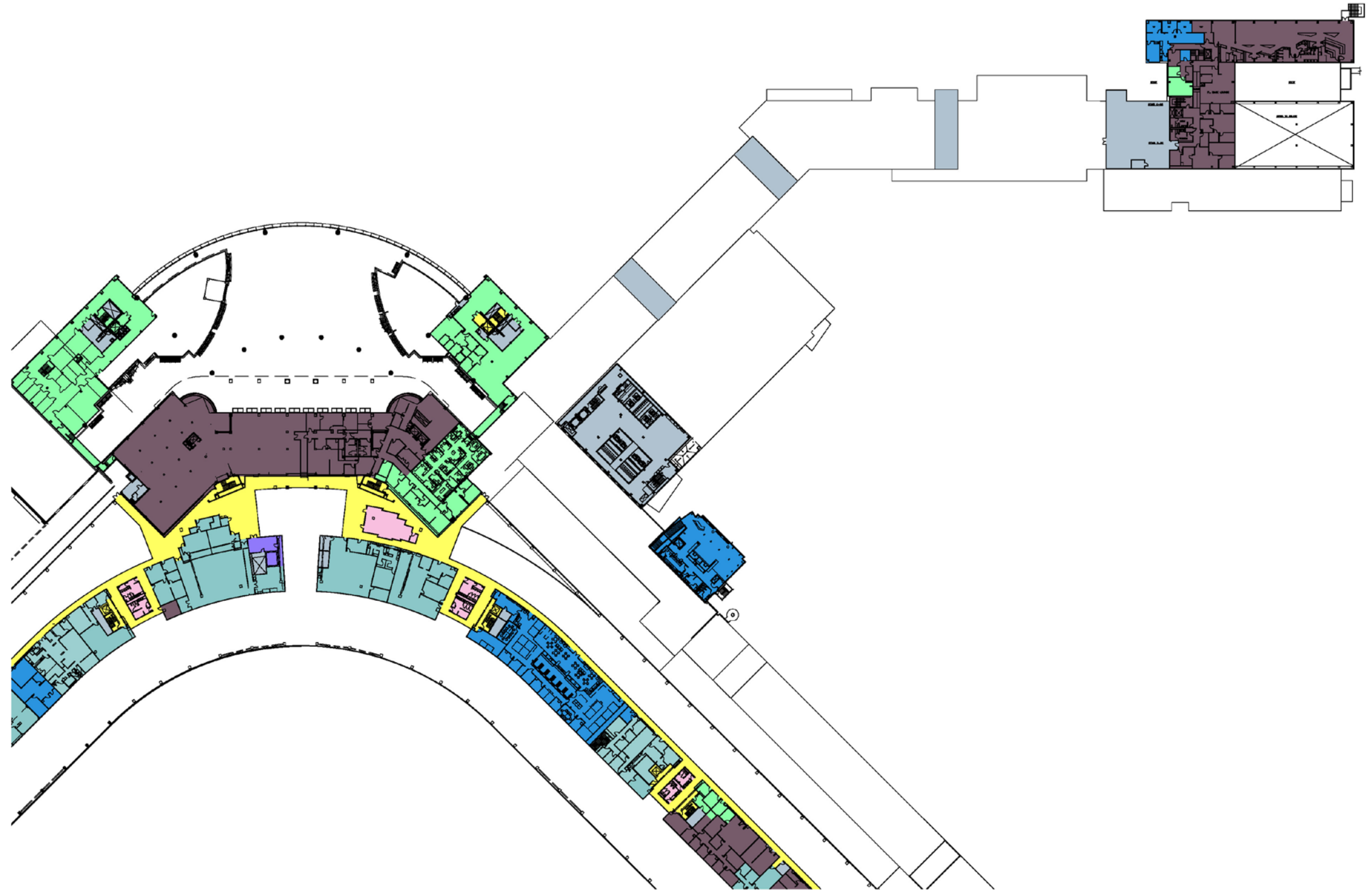
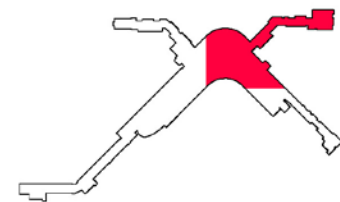


Source: 2014 POS AutoCAD base files and terminal space allocations

Figure 3-29  
**Overall Terminal Functional Allocation – Mezzanine Level Area 3**  
 Seattle-Tacoma International Airport

LEGEND

- Check-in counter area
- Check-in counter area (Alaska)
- Check-in queuing
- ATO
- ATO (Alaska)
- Other airline space
- Security screening
- Baggage claim/handling
- Holdrooms
- Concessions
- Passenger services
- International arrivals (FIS/CBP)
- Airport & other agency offices
- Public circulation
- Building services
- Building utilities
- Ground transportation
- Vacant/unassigned
- Unidentified

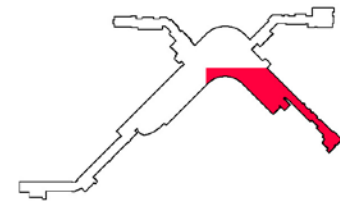
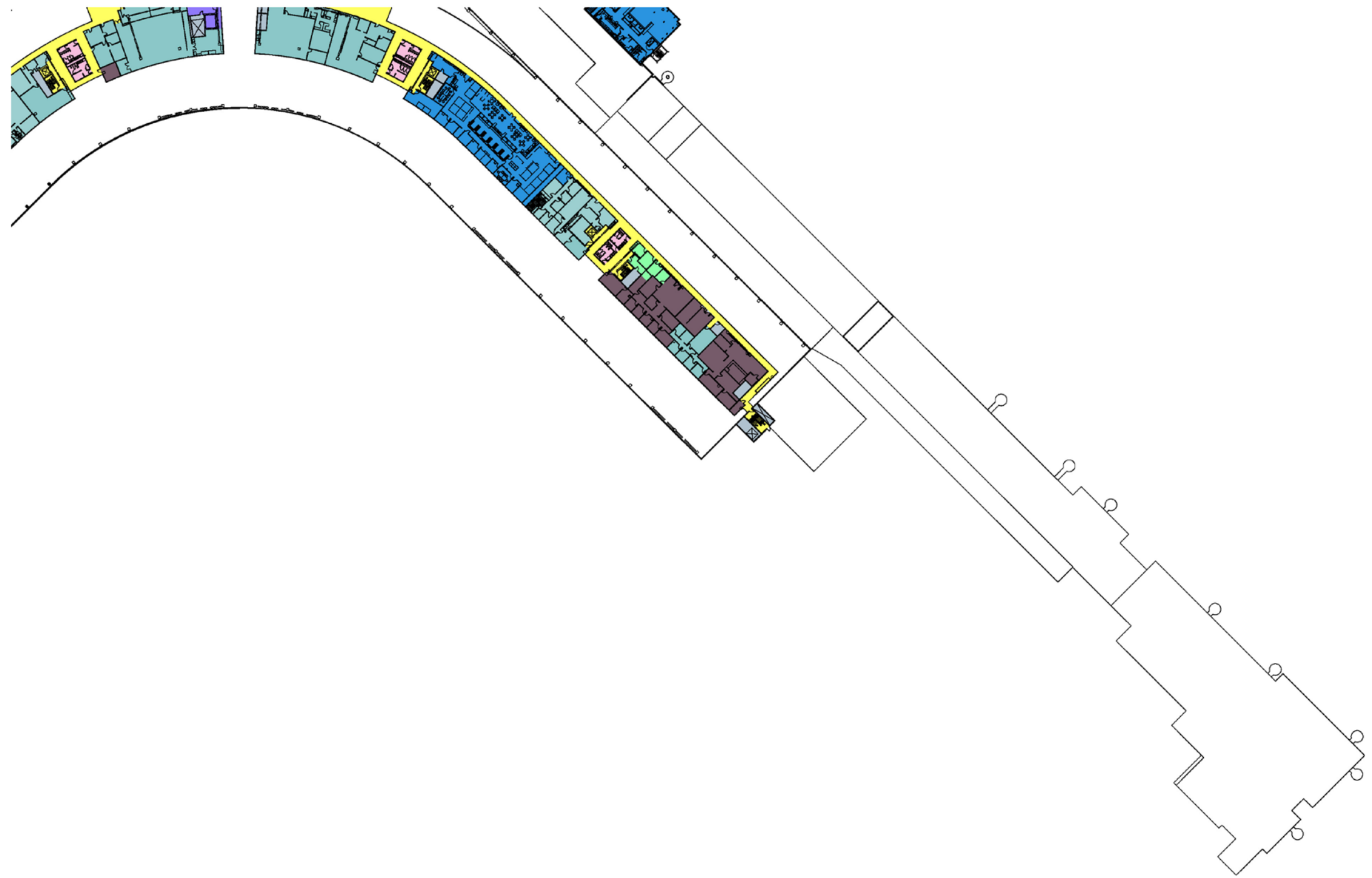


Source: 2014 POS AutoCAD base files and terminal space allocations

Figure 3-30  
**Overall Terminal Functional Allocation – Mezzanine Level Area 4**  
 Seattle-Tacoma International Airport

LEGEND

- Check-in counter area
- Check-in counter area (Alaska)
- Check-in queuing
- ATO
- ATO (Alaska)
- Other airline space
- Security screening
- Baggage claim/handling
- Holdrooms
- Concessions
- Passenger services
- International arrivals (FIS/CBP)
- Airport & other agency offices
- Public circulation
- Building services
- Building utilities
- Ground transportation
- Vacant/anassigned
- Unidentified

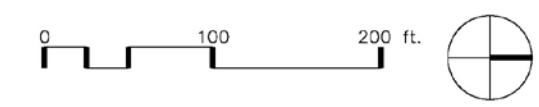
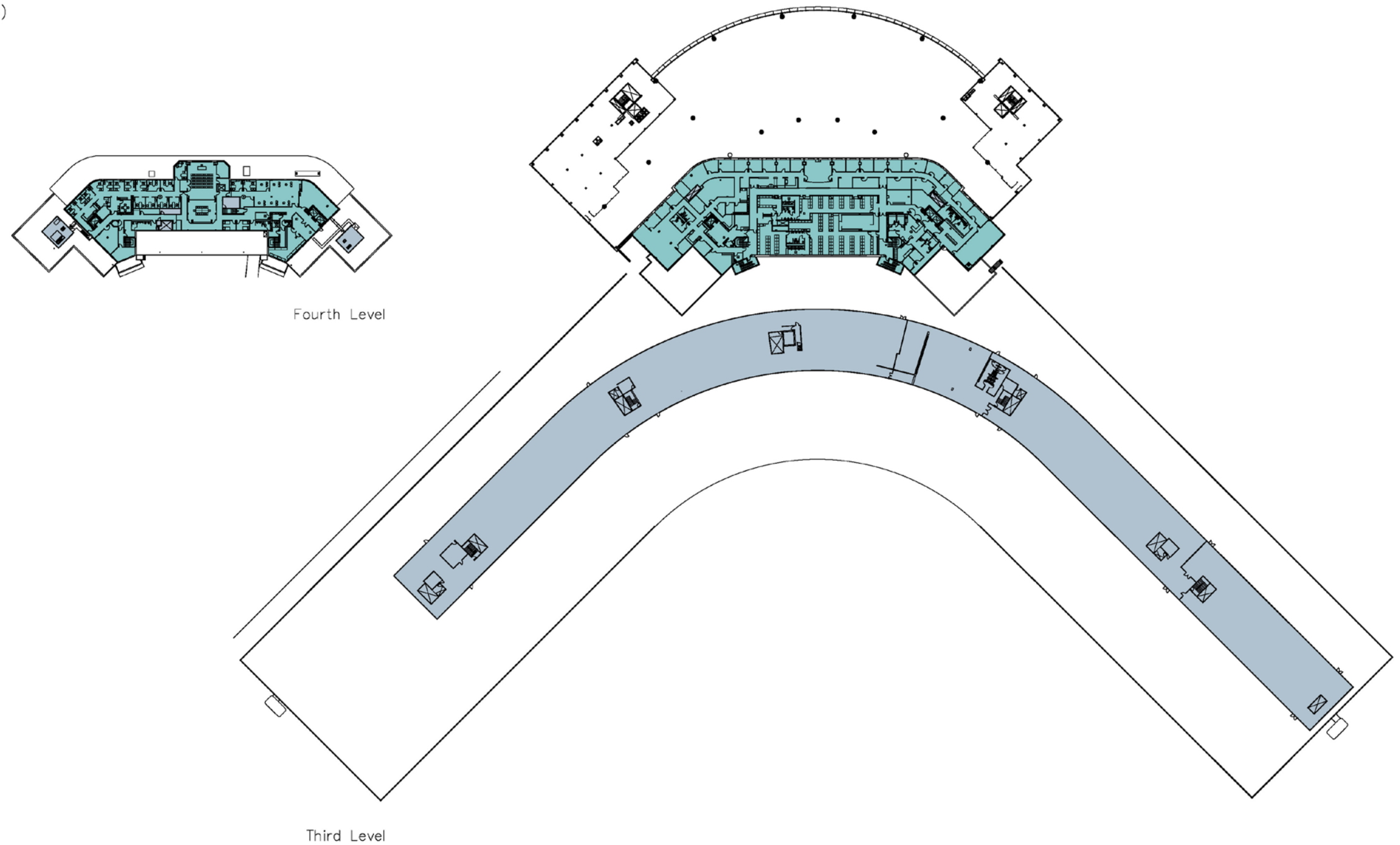
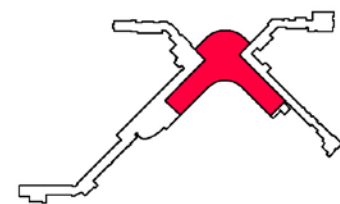


Source: 2014 POS AutoCAD base files and terminal space allocations

Figure 3-31  
**Overall Terminal Functional Allocation – Third & Fourth Levels**  
 Seattle-Tacoma International Airport

LEGEND

- Check-in counter area
- Check-in counter area (Alaska)
- Check-in queuing
- ATO
- ATO (Alaska)
- Other airline space
- Security screening
- Baggage claim/handling
- Holdrooms
- Concessions
- Passenger services
- International arrivals (FIS/CBP)
- Airport & other agency offices
- Public circulation
- Building services
- Building utilities
- Ground transportation
- Vacant/anassigned
- Unidentified

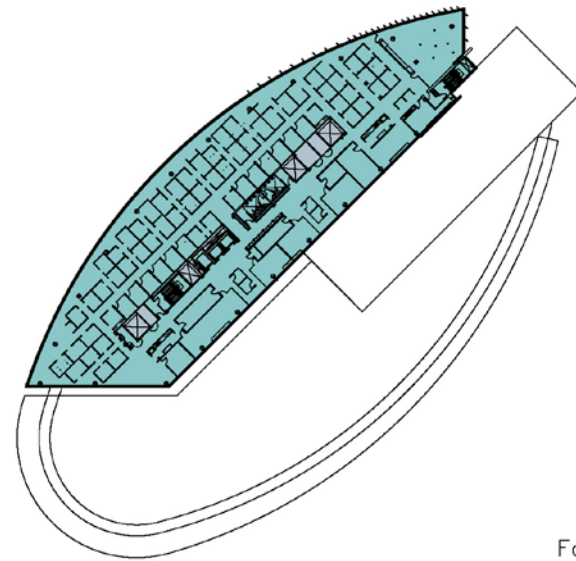
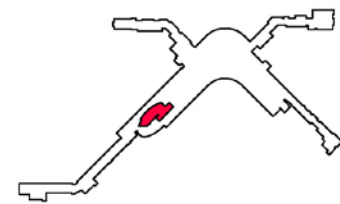


Source: 2014 POS AutoCAD base files and terminal space allocations

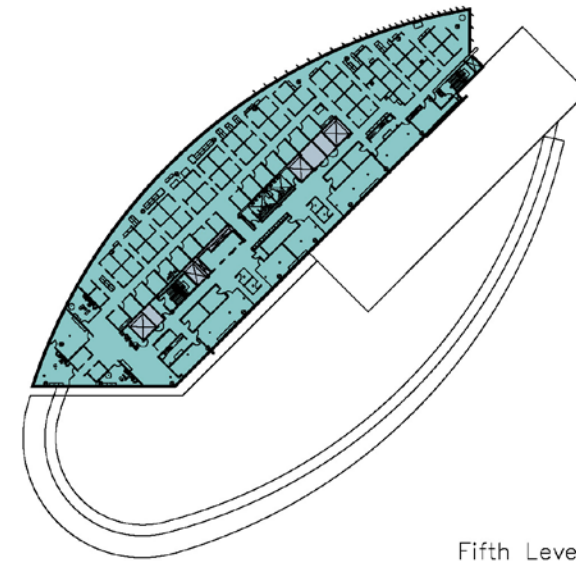
Figure 3-32  
**Overall Terminal Functional Allocation – Office Building**  
 Seattle-Tacoma International Airport

LEGEND

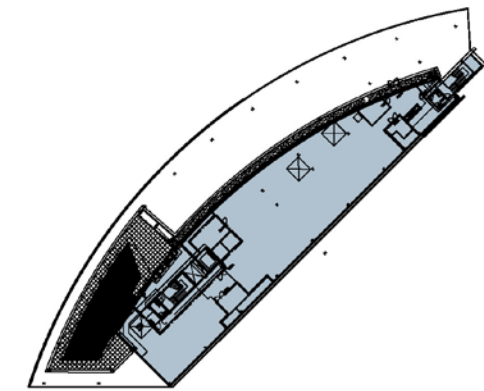
- Check-in counter area
- Check-in counter area (Alaska)
- Check-in queuing
- ATO
- ATO (Alaska)
- Other airline space
- Security screening
- Baggage claim/handling
- Holdrooms
- Concessions
- Passenger services
- International arrivals (FIS/CBP)
- Airport & other agency offices
- Public circulation
- Building services
- Building utilities
- Ground transportation
- Vacant/anassigned
- Unidentified



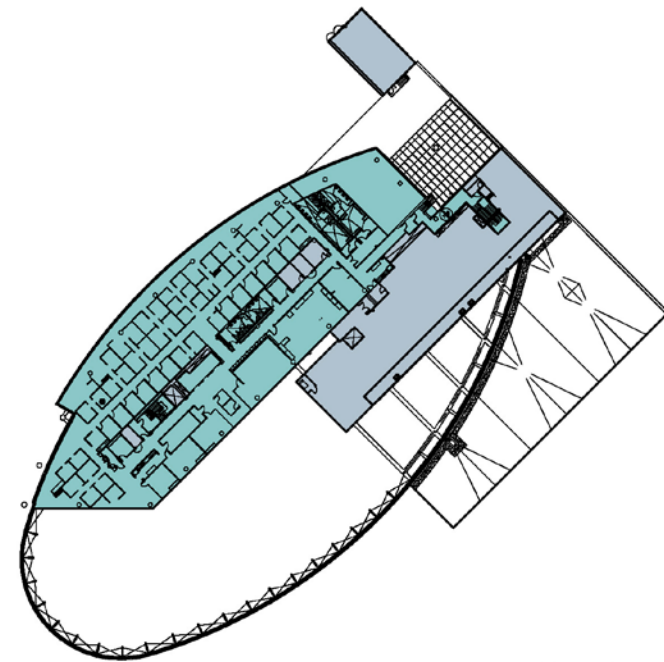
Fourth Level



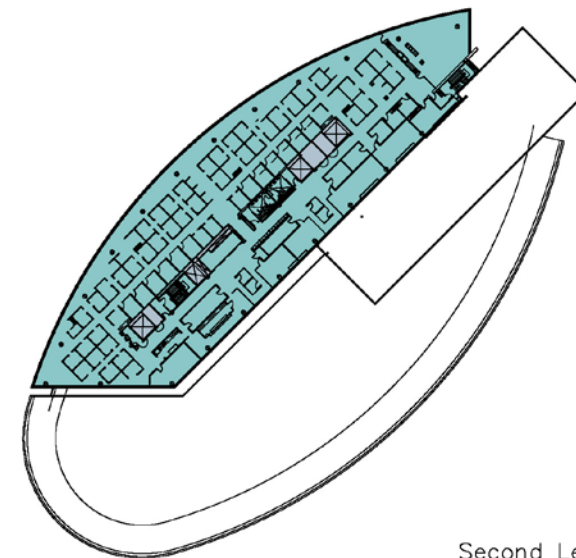
Fifth Level



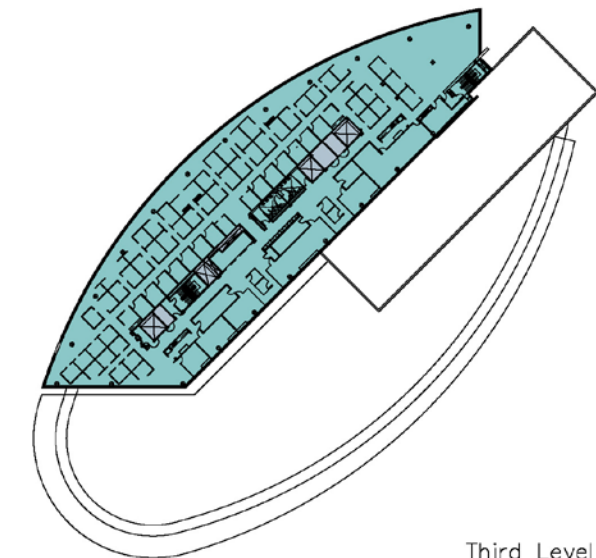
Penthouse Level



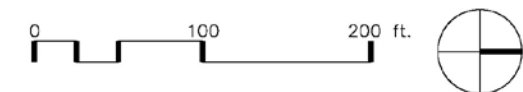
First Level



Second Level



Third Level

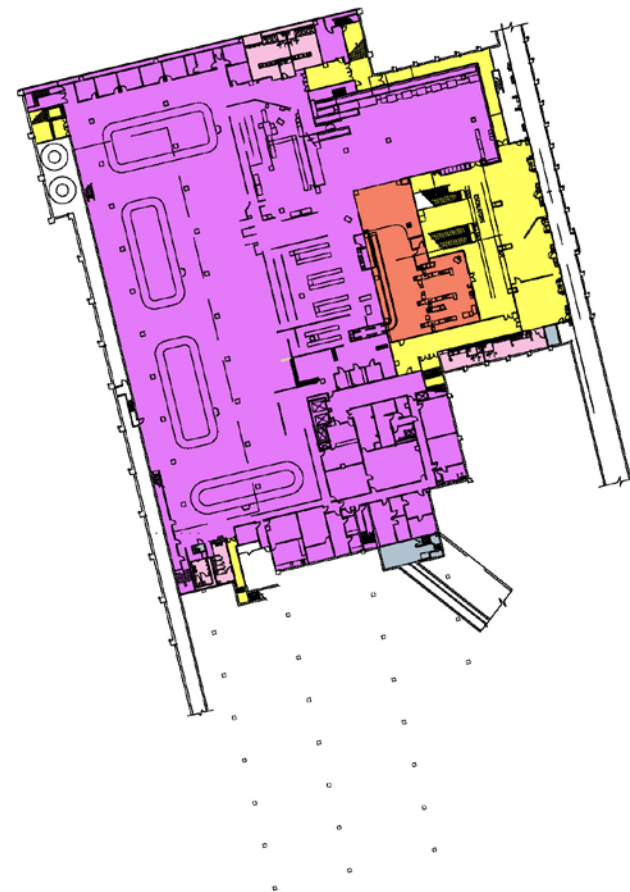
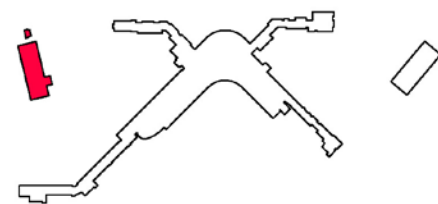


Source: 2014 POS AutoCAD base files and terminal space allocations

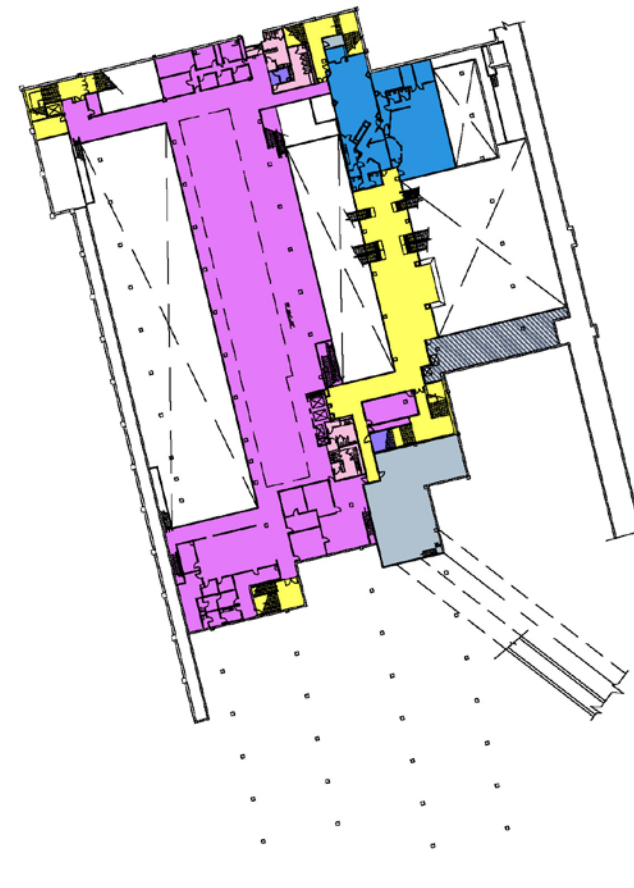
Figure 3-33  
**South Satellite Functional Allocation – STS, FIS and Ramp Levels**  
 Seattle-Tacoma International Airport

LEGEND

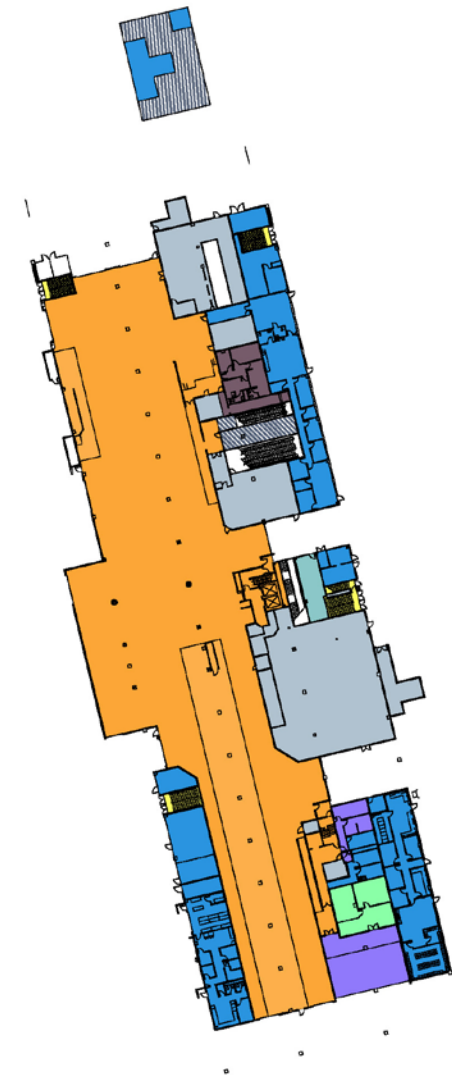
- Check-in counter area
- Check-in counter area (Alaska)
- Check-in queuing
- ATO
- ATO (Alaska)
- Other airline space
- Security screening
- Baggage claim/handling
- Holdrooms
- Concessions
- Passenger services
- International arrivals (FIS/CBP)
- Airport & other agency offices
- Public circulation
- Building services
- Building utilities
- Ground transportation
- Vacant/unassigned
- Unidentified



STS Level



FIS Level



Ramp Level



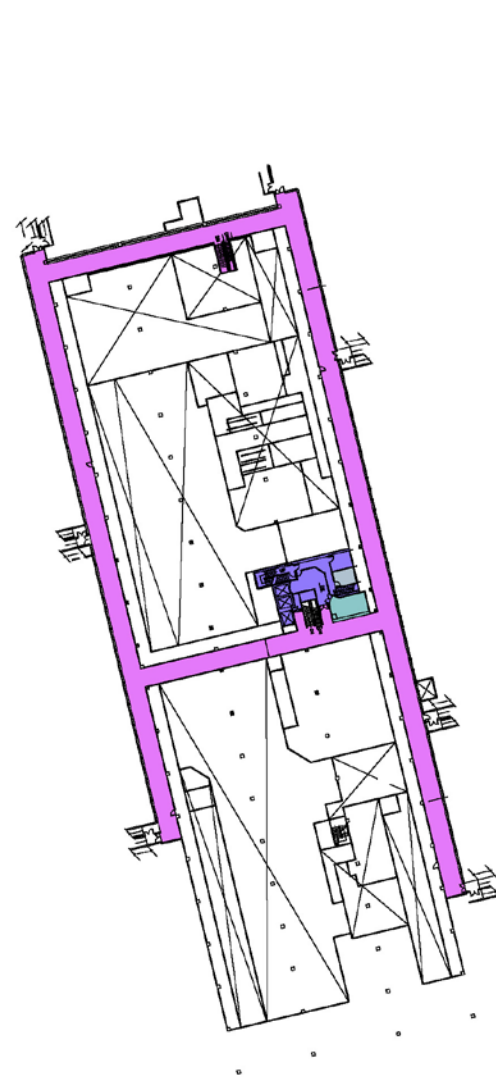
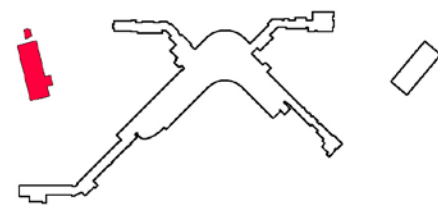
Source: 2014 POS AutoCAD base files and terminal space allocations



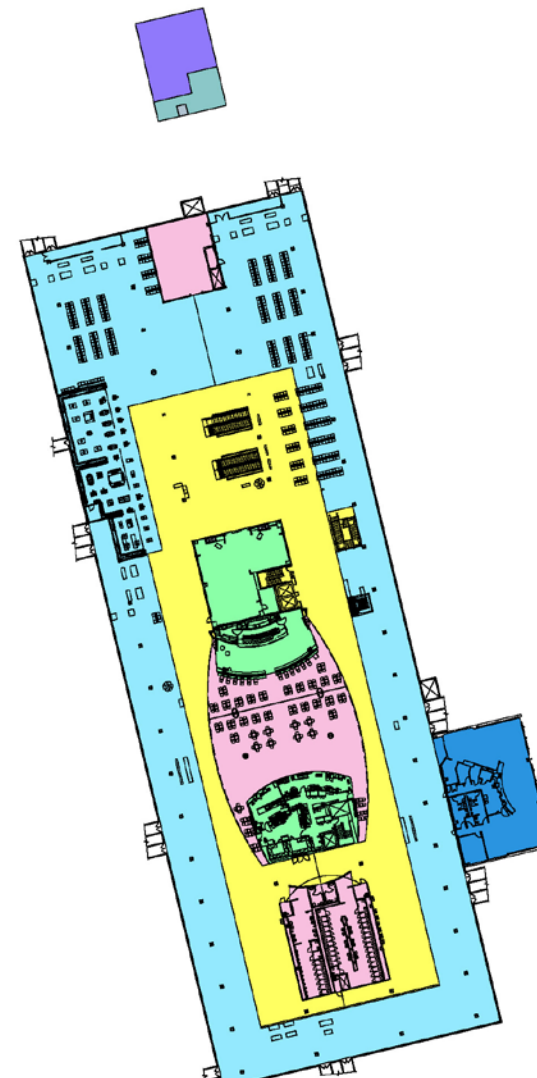
Figure 3-34  
**South Satellite Functional Allocation – Secure Corridor Concourse & Penthouse Levels**  
 Seattle-Tacoma International Airport

LEGEND

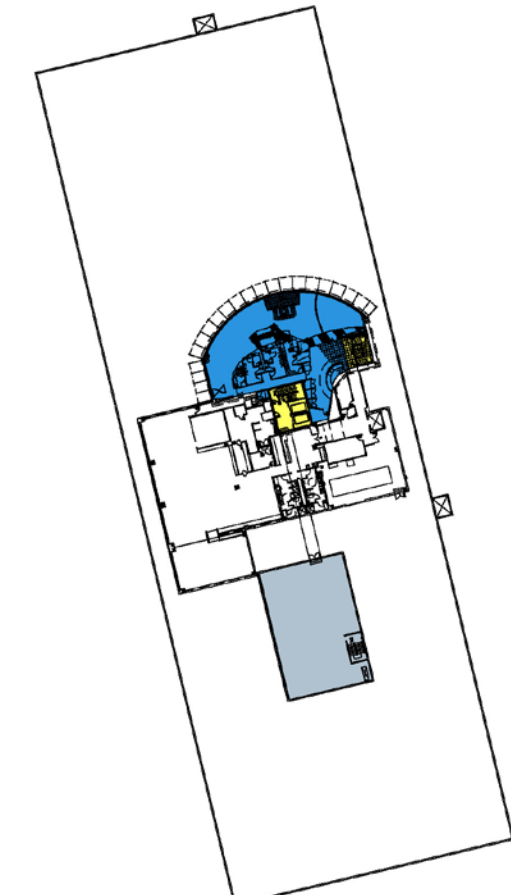
- Check-in counter area
- Check-in counter area (Alaska)
- Check-in queuing
- ATO
- ATO (Alaska)
- Other airline space
- Security screening
- Baggage claim/handling
- Holdrooms
- Concessions
- Passenger services
- International arrivals (FIS/CBP)
- Airport & other agency offices
- Public circulation
- Building services
- Building utilities
- Ground transportation
- Vacant/anassigned
- Unidentified



Secure Corridor Level



Concourse Level



Penthouse Level

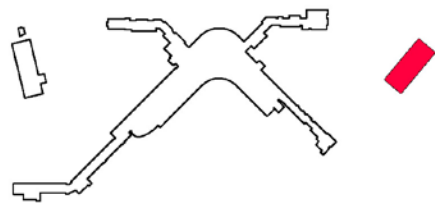


Source: 2014 POS AutoCAD base files and terminal space allocations

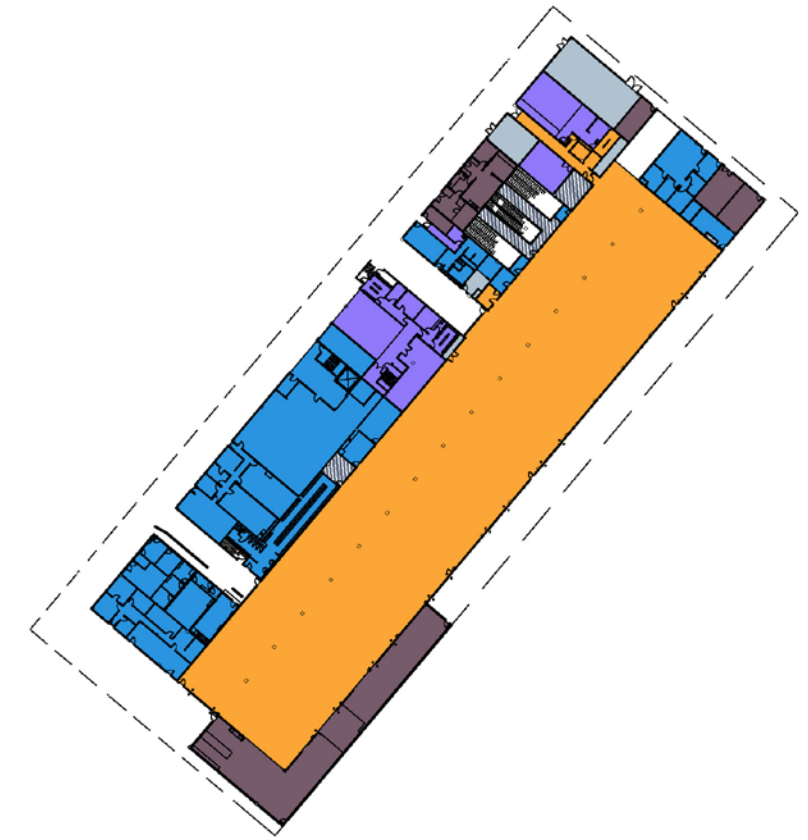
Figure 3-35  
**North Satellite Functional Allocation – STS and Ramp Levels**  
 Seattle-Tacoma International Airport

LEGEND

- Check-in counter area
- Check-in counter area (Alaska)
- Check-in queuing
- ATO
- ATO (Alaska)
- Other airline space
- Security screening
- Baggage claim/handling
- Holdrooms
- Concessions
- Passenger services
- International arrivals (FIS/CBP)
- Airport & other agency offices
- Public circulation
- Building services
- Building utilities
- Ground transportation
- Vacant/anassigned
- Unidentified



STS Level



Ramp Level

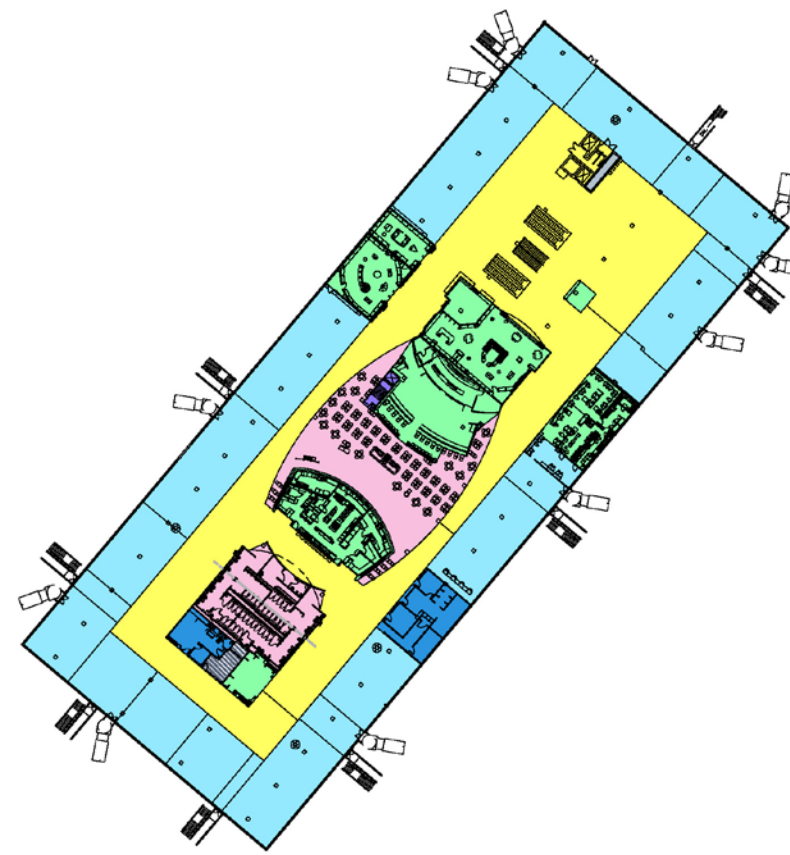
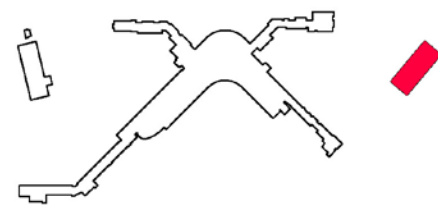


Source: 2014 POS AutoCAD base files and terminal space allocations

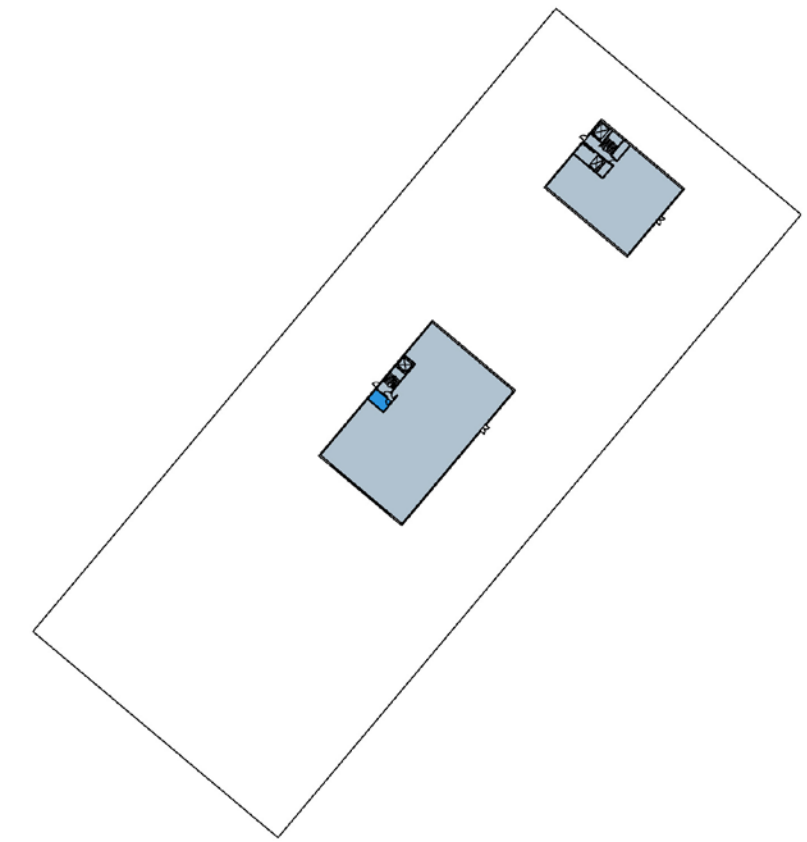
Figure 3-36  
**North Satellite Functional Allocation – Concourse & Penthouse Levels**  
 Seattle-Tacoma International Airport

LEGEND

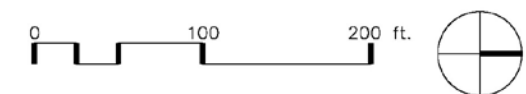
- Check-in counter area
- Check-in counter area (Alaska)
- Check-in queuing
- ATO
- ATO (Alaska)
- Other airline space
- Security screening
- Baggage claim/handling
- Holdrooms
- Concessions
- Passenger services
- International arrivals (FIS/CBP)
- Airport & other agency offices
- Public circulation
- Building services
- Building utilities
- Ground transportation
- Vacant/anassigned
- Unidentified



Concourse Level



Penthouse Level



Source: 2014 POS AutoCAD base files and terminal space allocations

Figure 3-37  
Security Checkpoints (Concourse Level)  
Seattle-Tacoma International Airport

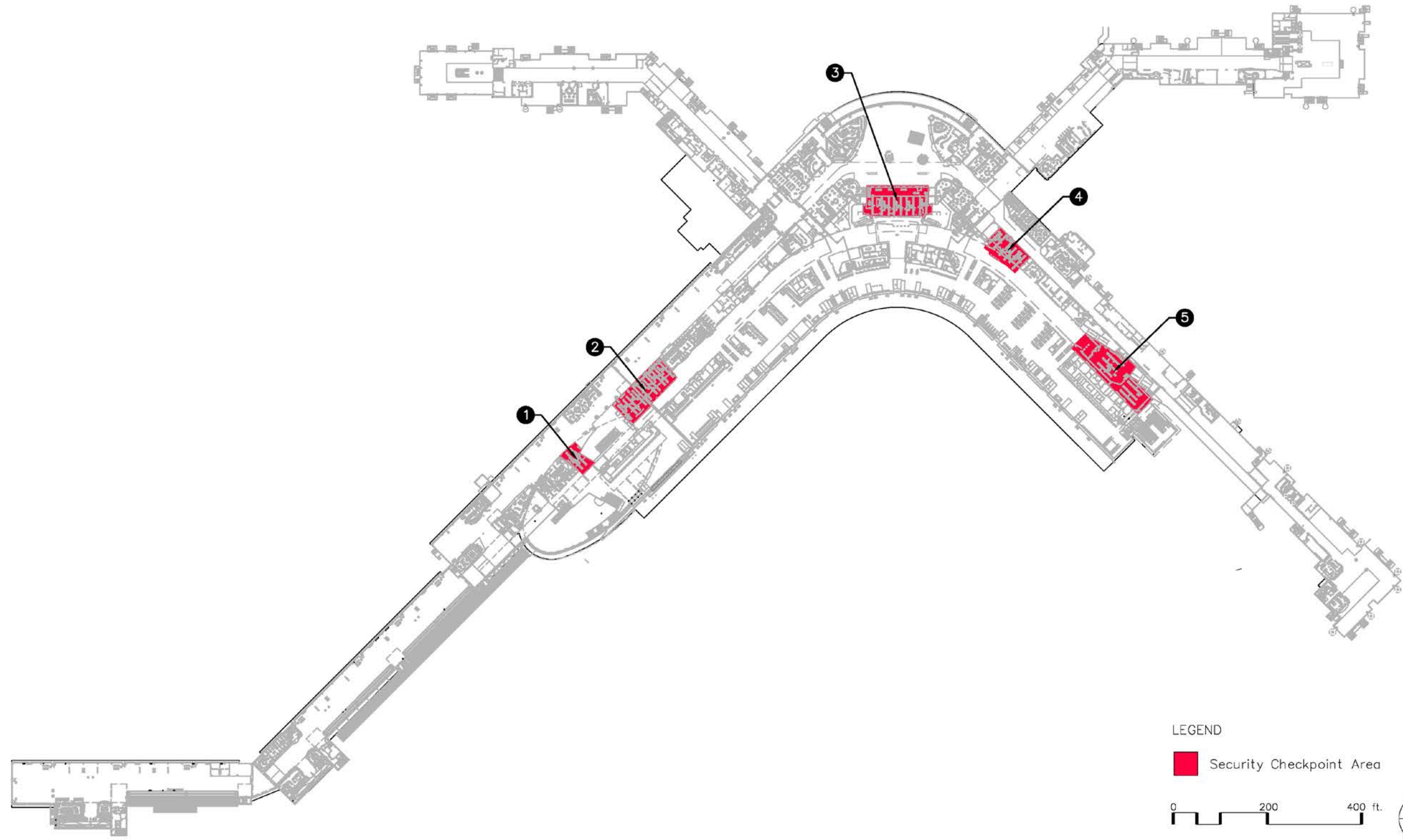
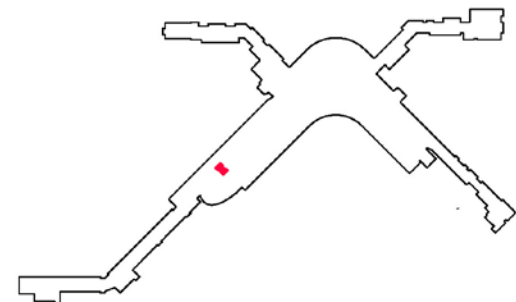
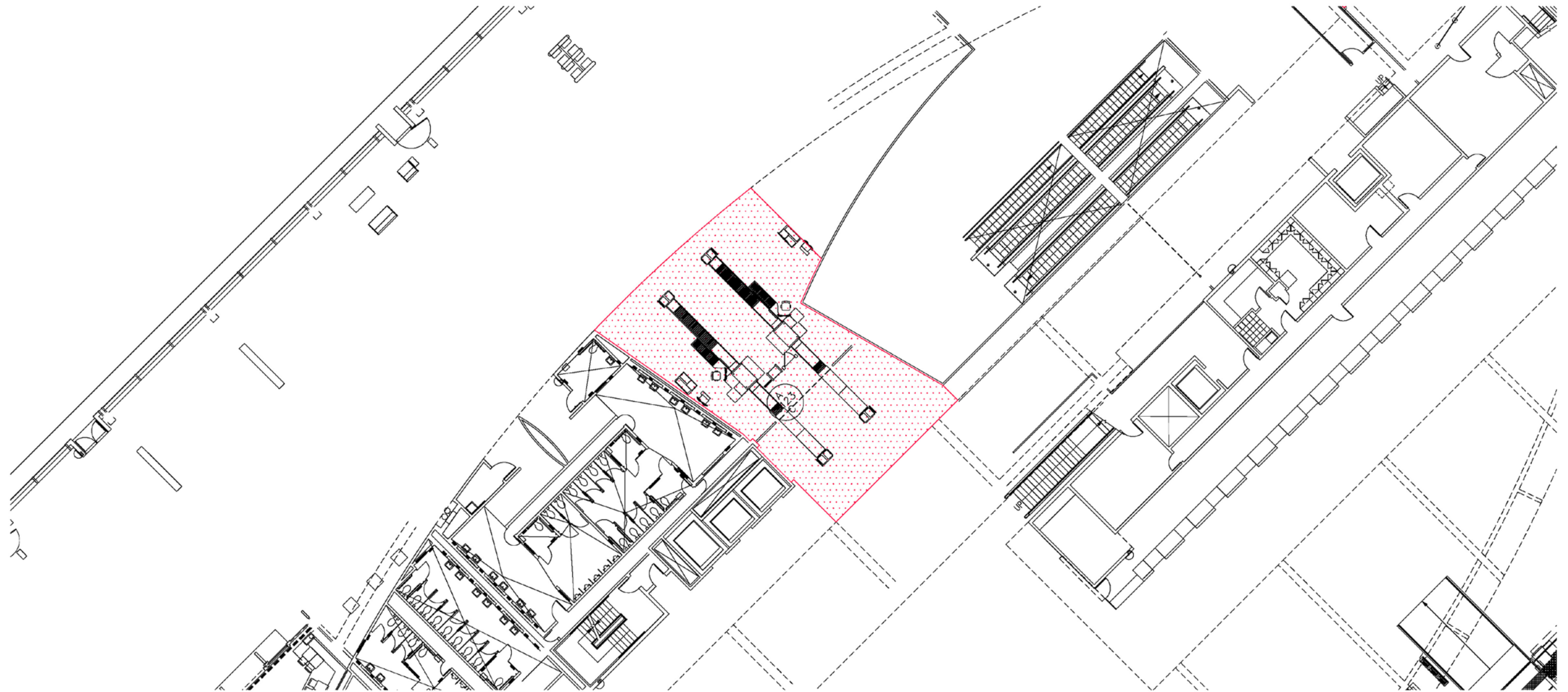



Figure 3-38  
Security Checkpoints Area 1  
Seattle-Tacoma International Airport



LEGEND

 Security checkpoint area

0 20 40 ft.



Source: POS Security Checkpoint Drawings (2013)

Figure 3-39  
Security Checkpoints Area 2  
Seattle-Tacoma International Airport

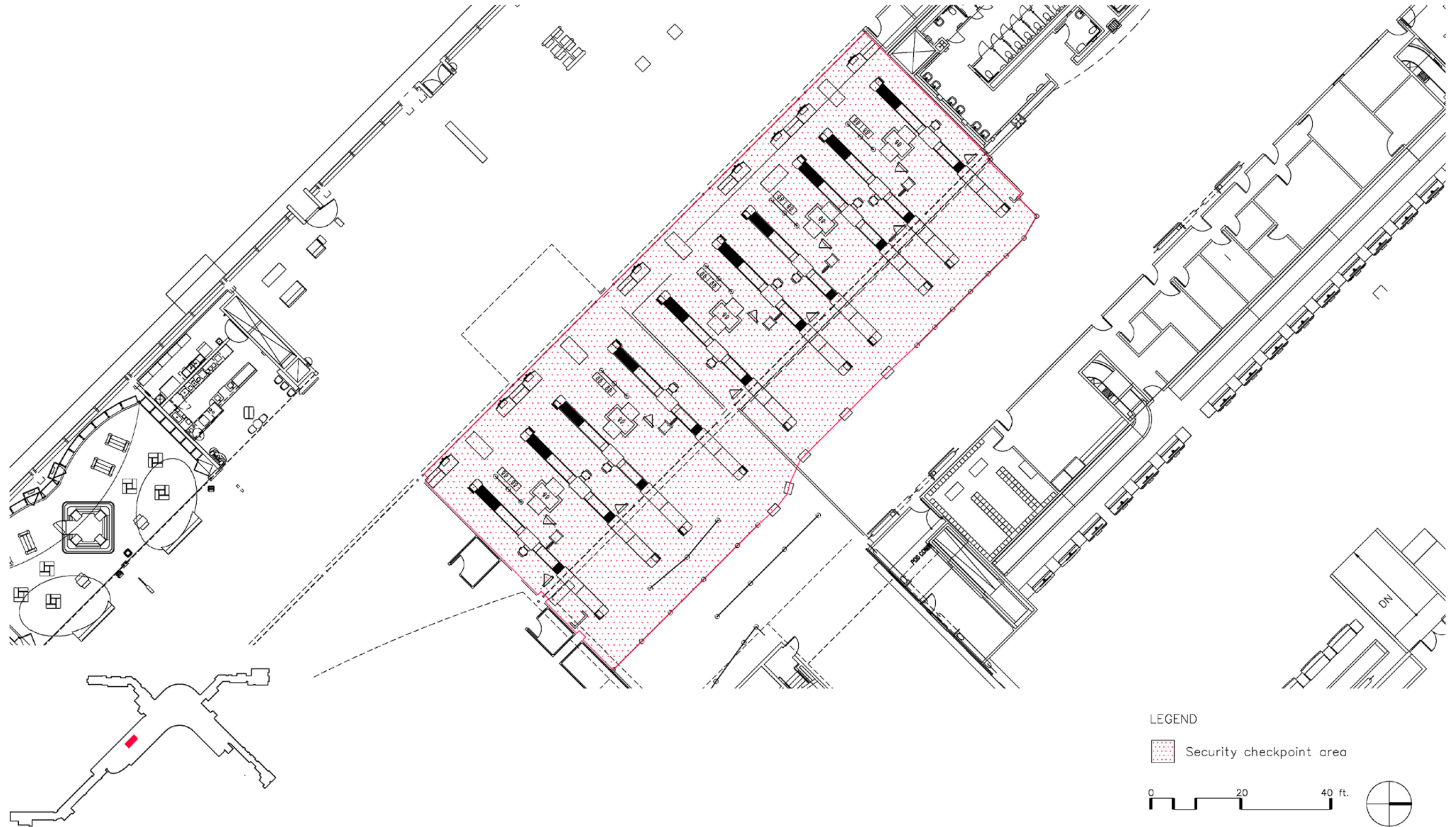


Figure 3-40  
Security Checkpoints Area 3  
Seattle-Tacoma International Airport

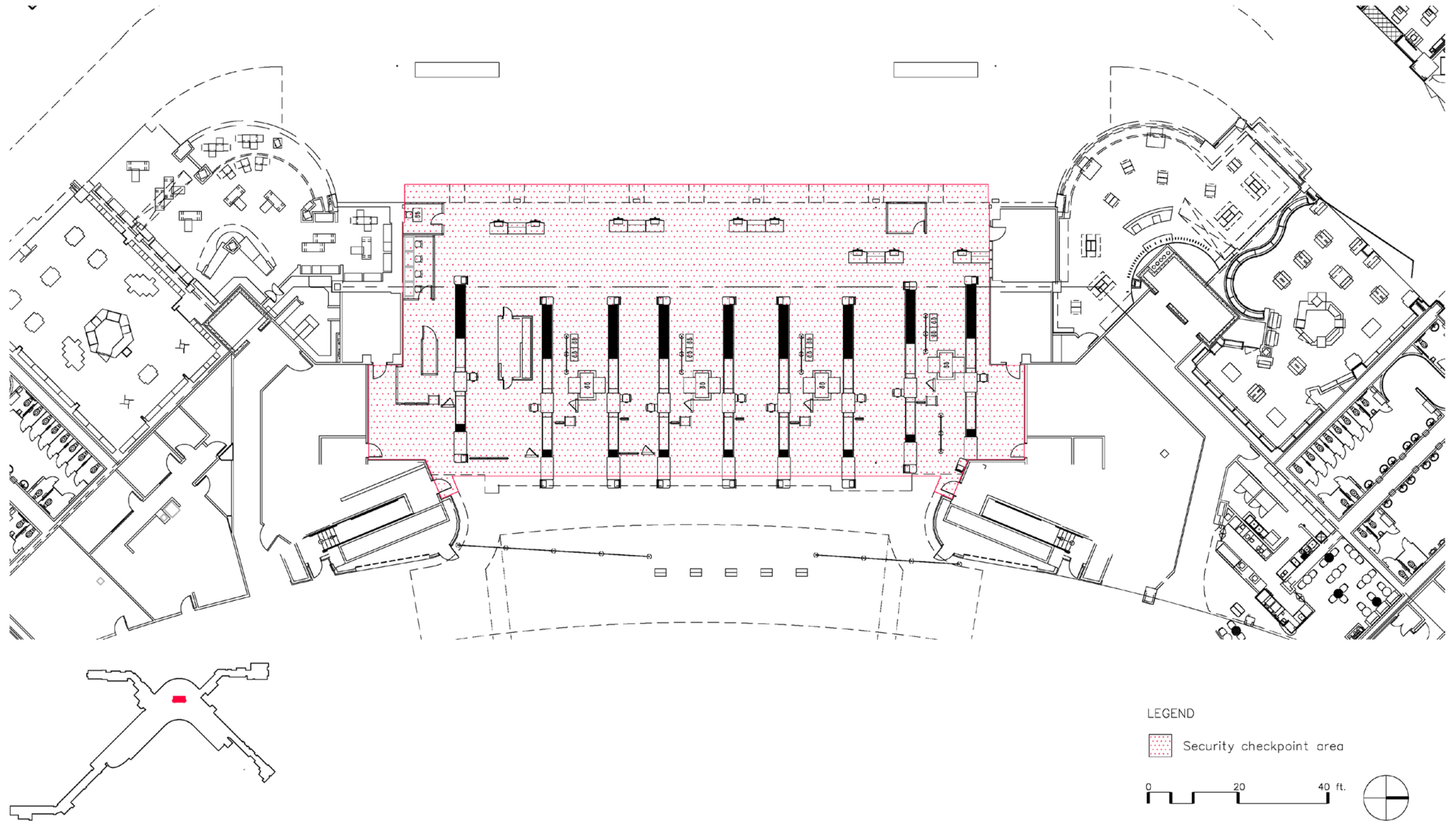


Figure 3-41  
Security Checkpoints Area 4  
Seattle-Tacoma International Airport



Source: POS Security Checkpoint Drawings (2013)



Figure 3-42  
Security Checkpoints Area 5  
Seattle-Tacoma International Airport



Source: POS Security Checkpoint Drawings (2013)

Table 3-1  
**Airlines Serving the Airport**  
 Seattle-Tacoma International Airport

ICAO code	Airline	Service type
ACA/JZA	Air Canada (Air Canada Jazz)	International
ASA	Alaska Airlines	Domestic
AAL/EGF	American Airlines (American Eagle)	Domestic
ANA	All Nippon Airways	International
AAR	Asiana Airlines	International
BAW	British Airways	International
CIB	Condor Airlines	International
DAL	Delta Air Lines	Domestic
UAE	Emirates Airlines	International
EVA	Eva Air	International
FFT	Frontier Airlines	Domestic
CHH	Hainan Airlines	International
HAL	Hawaiian Airlines	International
QXE	Horizon Air	Domestic
ICE	Icelandair	International
JBU	JetBlue Airways	Domestic
KAL	Korean Air	International
DLH	Lufthansa Airlines	International
SWA	Southwest Airlines	Domestic
SCX	Sun Country Airlines	Domestic
UAL	United Airlines	Domestic
USA	US Airways	Domestic
VRD	Virgin America	Domestic

Source: Port of Seattle website, 2014.

Table 3-2  
**On-Gate Parking for Maximum Aircraft Mix—Airline Assignments and Aircraft Parking Capabilities**  
 Seattle-Tacoma International Airport

Gate #	Airline	Airplane Design Group (ADG)				Gate #	Airline	Airplane Design Group (ADG)			
		ADG II (Small jet or turboprop)	ADG III (B-737, MD 80)	ADG IV (B-767)	ADG V (B-747)			ADG II (Small jet or turboprop)	ADG III (B-737, MD 80)	ADG IV (B-767)	ADG V (B-747)
<b>Concourse A (15 parking positions)</b>					<b>Concourse D (10 parking positions)</b>						
A1	Port		X			D1	Alaska		X		
A2	American		X	X		D2	Alaska		X		
A3	American		X	X		D3	Alaska		X		
A4	Port		X	X		D4	Port		X		
A5	United		X	X		D5	JetBlue		X	X	
A6A (A6)	United	X	X	X		D7	American		X	X	
A6B (A6)	United	X				D8	American		X	X	
A7	United	X	X			D9	American		X	X	
A8	United	X	X			D10	Alaska		X		
A9, A9A	United	X	X	X	X	D11	Alaska		X		
A10	United	X	X	X		<b>South Satellite (15 parking positions)</b>					
A11, A11A	United	X	X	X	X	S1	Port		X	X	X
A12	United	X	X	X	X	S2	Delta	X	X	X	
A13	United	X	X	X	X	S3, S3A	Delta	X	X	X	
A14	Air Canada/Jazz Air	X	X			S4	Delta		X	X	
<b>Concourse B (13 parking positions)</b>					<b>North Satellite ( 19 parking positions)</b>						
B1	Port		X	X		N1	Alaska		X		
B3, B3A	Delta		X	X	X	N2	Alaska		X		
B4	Delta		X			N3	Alaska		X		
B5	Delta		X	X	X	N6	Alaska		X		
B6	Southwest		X			N7	Alaska		X		
B7	Delta		X	X		N8	Alaska		X		
B8	Southwest		X			Q30	Alaska	X			
B9	Delta		X	X		Q31	Alaska	X			
B10	Southwest		X			Q32	Alaska	X			
B11	Virgin		X	X		Q33	Alaska	X			
B12	Southwest		X			N11	Alaska		X		
B14	Southwest		X			N12A	Horizon	X			
B15, B15A	Port		X	X		N12B	Horizon	X			
<b>Concourse C (20 parking positions)</b>					<b>North Satellite ( 19 parking positions)</b>						
Q1	Horizon	X				N12C	Horizon	X			
Q2	Horizon	X				N12D	Horizon	X			
Q3	Horizon	X				N12E	Horizon	X			
Q4	Horizon	X				N14	Alaska		X		
Q5	Horizon	X				N15	Alaska		X		
Q6	Horizon	X				N16	Alaska		X		
Q7	Horizon	X									
Q8	Horizon	X									
Q10	Horizon	X									
Q12	Horizon	X									
Q13	Horizon	X									
Q14	Horizon	X									
Q15	Horizon	X									
Q16	Horizon	X									
C9	Horizon		X								
C11	Alaska		X								
C15	Alaska		X								
C17	Alaska		X								
C18	Alaska	X	X								
C20	Alaska		X								

Notes: On-gate parking is defined in this table as passenger loading bridges and commonly used ground loading and unloading positions.  
 Sources: Aircraft parking capabilities from *Overall Aircraft Parking Layout, Port of Seattle, November 21, 2014*. Airline assignments from Port of Seattle, January 2014.

Table 3-3  
**Off-Gate Parking Available for Remain Overnight Aircraft**  
 Seattle-Tacoma International Airport

Ramp Location	Control	Airplane Design Group (ADG) – Mix A						Airplane Design Group (ADG) – Mix B					
		ADG II (Small jet or turboprop)	ADG III (B-737)	ADG IV (B-767)	ADG V (B-747)	ADG VI (A380)	Total	ADG II (Small jet or turboprop)	ADG III (B-737))	ADG IV (B-767)	ADG V (B-747)	ADG VI (A380)	Total
<b>PASSENGER TERMINAL</b>													
South Satellite	Airline	--	--	--	--	--	--	--	--	--	--	--	--
Concourse A	Airline	--	1	1	--	--	2	--	1	1	--	--	2
Concourse B	Airline	--	--	--	--	--	--	--	--	--	--	--	--
Concourse C	Airline	--	1	--	--	--	1	--	1	--	--	--	1
Concourse D	Airline	--	1	--	--	--	1	--	1	--	--	--	1
North Satellite	Airline	--	<u>1</u>	--	--	--	<u>1</u>	--	<u>1</u>	--	--	--	<u>1</u>
Subtotal		--	4	1	--	--	5	--	4	1	--	--	5
<b>AIRLINE MAINTENANCE HANGARS</b>													
Alaska Hangar	Alaska	--	9	--	--	--	9	--	9	--	--	--	9
Delta Hangar	Delta	--	--	2	4	--	6	--	--	2	4	--	6
United Maintenance	United	--	<u>1</u>	<u>1</u>	--	--	<u>2</u>	--	<u>1</u>	<u>1</u>	--	--	<u>2</u>
Subtotal		--	10	3	4	--	17	--	10	3	4	--	17
<b>AIR CARGO HARDSTANDS</b>													
Air Cargo 1	Port	2	--	--	--	--	2	2	--	--	--	--	2
Air Cargo 2	Port	--	5	2	--	--	7	--	5	2	--	--	7
Air Cargo 3	Port	--	2	--	--	--	2	--	--	--	1	--	1
Air Cargo 4	Port	--	3	--	--	--	3	--	--	2	--	--	2
Air Cargo 5	Port	1	8	--	--	--	9	--	2	--	1	2	5
Air Cargo 6	Port	--	2	1	--	--	3	--	--	--	2	--	2
Air Cargo 7	Port	--	<u>7</u>	<u>2</u>	--	--	<u>9</u>	--	--	<u>3</u>	--	<u>1</u>	<u>4</u>
Subtotal		3	27	5	--	--	35	2	7	7	4	3	23
Total		3	41	9	4	--	57	2	21	11	8	3	45

Notes:

RON = Remain overnight.

This table excludes off-gate aircraft parking positions not available for aircraft RON parking (e.g., FedEx and Alaska cargo).

Source: Port of Seattle, 2014.

Table 3-4  
**Terminal Space Summary – Main Terminal**  
 Seattle-Tacoma International Airport

Function	Main terminal areas (s.f.)							Total	
	Mezzanine	Concourse	Bridge	Baggage	STS	3RD floor	4TH floor		Office tower
1. Check-in counter area	--	17,486	127	--	--	--	--	--	17,613
2. Check -in queuing	--	27,583	112	--	--	--	--	--	27,695
3. Airline ticket offices	--	30,155	--	--	--	--	--	--	30,155
4. Other airline space	--	--	--	--	--	--	--	--	142,592
A. Airline clubroom	16,981	6,662	--	--	--	--	--	--	23,643
B. Ground handling ramp op and storage	--	--	68,083	20,037	--	--	--	--	88,120
C. Airline support	21,725	7,949	--	1,155	--	--	--	--	30,829
5. Security screening	--	--	--	--	--	--	--	--	139,268
A. Passenger screening checkpoints	--	52,617	--	--	--	--	--	--	52,617
B. Employees/delivery screening checkpoint	--	--	--	--	--	--	--	--	--
C. Checked baggage screening	--	4,304	54,275	28,072	--	--	--	--	86,651
6. Baggage	--	--	--	--	--	--	--	--	374,559
A. Outbound baggage handling	--	1,879	89,627	152,897	--	--	--	--	244,403
B. Inbound baggage security screening	--	--	6,319	34,208	--	--	--	--	40,527
C. Baggage claim	--	--	--	80,727	--	--	--	--	80,727
D. Baggage service offices	--	--	--	8,902	--	--	--	--	8,902
7. Hold rooms	--	135,839	--	--	--	--	--	--	135,839
8. Concessions	--	--	--	--	--	--	--	--	152,979
A. Food/beverage concessions	--	60,978	--	521	--	--	--	--	61,499
B. News/gift/specialty retail concessions	--	35,181	--	2,472	--	--	--	--	37,653
C. Services	--	3,117	--	1,053	--	--	--	--	4,170
D. Duty free	--	1,588	--	--	--	--	--	--	1,588
E. Remote support	16,635	--	--	16,420	--	--	--	--	33,055
F. Vacant concession	--	15,014	--	--	--	--	--	--	15,014
9. Passenger service	--	--	--	--	--	--	--	--	104,977
A. Restrooms	3,494	27,837	--	9,203	--	--	--	--	40,534
B. Other passenger service	1,264	41,928	--	21,251	--	--	--	--	64,443
10. International arrivals (FIS)	--	--	--	--	--	--	--	--	--
11. Airport and other agency offices	--	--	--	--	--	--	--	--	362,620
A. Port of Seattle	26,027	--	37,040	42,004	68,109	28,491	13,552	115,029	330,252
B. Other agency office/operations support	11,409	13,762	--	649	6,548	--	--	--	32,368
12. Public circulation	--	--	--	--	--	--	--	--	560,960
A. Secure area public circulation	2,588	235,742	8,304	11,337	13,591	--	--	--	271,562
B. Non-secure area public circulation	30,171	146,872	32,562	58,262	--	--	--	--	267,867
C. STS guideway	--	--	--	--	21,531	--	--	--	21,531
13. Building services	691	5,412	20,835	30,602	21,629	--	--	--	79,169
14. Building utilities	28,628	3,920	68,792	46,333	185,200	75,693	1,219	26,427	436,212
15. Rental car	--	--	--	8,279	--	--	--	--	8,279
16. Vacant	39,702	3,868	30,729	15,115	--	--	--	--	89,414
17. Unknown	496	16,568	2,508	6,189	10,551	--	--	--	36,312

Source: Port of Seattle, Terminal Development Strategy, 2012.

Table 3-5  
**Terminal Space Summary – South Satellite**  
 Seattle-Tacoma International Airport

Function	South Satellite areas (s.f.)						Total
	Penthouse	Concourse	Secure corridor	Bridge	FIS	STS	
1. Check-in counter area	--	--	--	--	--	--	--
2. Check-in queuing	--	--	--	--	--	--	--
3. Airline ticket offices	--	--	--	--	--	--	--
4. Other airline space	--	--	--	--	--	--	24,967
A. Airline clubroom	4,608	4,153	--	4,457	--	--	13,218
B. Ground handling ramp op and storage	--	--	11,749	--	--	--	11,749
C. Airline support	--	--	--	--	--	--	--
5. Security screening	--	--	--	--	--	--	4,114
A. Passenger screening checkpoints	--	--	--	--	--	--	--
B. Employees/delivery screening	--	--	--	--	--	--	--
C. Checked baggage screening	--	--	--	--	--	4,114	4,114
6. Baggage	--	--	--	--	--	--	36,340
A. Outbound baggage handling	--	--	--	30,010	--	--	30,010
B. Inbound baggage security screening	--	--	--	6,330	--	--	6,330
C. Baggage claim	--	--	--	--	--	--	--
D. Baggage service offices	--	--	--	--	--	--	--
7. Hold rooms	--	40,163	--	--	--	--	40,163
8. Concessions	--	--	--	--	--	--	11,577
A. Food/beverage concessions	--	4,699	--	--	--	--	4,699
B. News/gift/specialty retail concessions	--	2,329	--	--	--	--	2,329
C. Services	--	--	--	1,025	--	--	1,025
D. Duty free	--	3,524	--	--	--	--	3,524
E. Remote support	--	--	--	--	--	--	--
F. Vacant concession	--	--	--	--	--	--	--
9. Passenger service	--	--	--	--	--	--	--
A. Restroom	--	--	--	--	--	--	--
B. Other passenger services	--	--	--	--	--	--	--
10. International arrivals (FIS)	--	--	12,365	--	24,732	54,295	91,392
11. Airport and other agency offices	--	--	--	--	--	--	1,491
A. Port of Seattle	--	672	314	505	--	--	1,491
B. Other agency office/operations support	--	--	--	--	--	--	--
12. Public circulation	--	--	--	--	--	--	42,960
A. Secure area public circulation	825	23,559	--	1,009	--	6,514	31,907
B. Non-secure area public circulation	--	--	--	--	7,785	--	7,785
C. STS guideway	--	--	--	--	--	3,268	3,268
13. Building services	--	1,763	1,381	2,109	156	--	5,409
14. Building utilities	3,954	173	130	10,982	2,990	611	18,840
15. Rental car	--	--	--	--	--	--	--
16. Vacant	--	--	--	1,142	--	--	1,142
17. Unknown	--	--	--	1,932	1,725	--	3,657

Source: Port of Seattle, Terminal Development Strategy, 2012.

Table 3-6  
**Terminal Space Summary – North Satellite**  
 Seattle-Tacoma International Airport

Function	North Satellite areas (s.f.)				Total
	Penthouse	Concourse	Bridge	STS	
1. Check-in counter area	--	--	--	--	--
2. Check-in queuing	--	--	--	--	--
3. Airline ticket offices	--	--	--	--	--
4. Other airline space	--	--	--	--	26,028
A. Airline clubroom	--	--	--	7,085	7,085
B. Ground handling ramp op and storage	--	--	14,503	--	14,503
C. Airline support	93	2,316	--	2,031	4,440
5. Security screening	--	--	--	--	--
A. Passenger screening checkpoints	--	--	--	--	--
B. Employees/delivery screening	--	--	--	--	--
C. Checked baggage screening	--	--	--	--	--
6. Baggage	--	--	--	--	34,579
A. Outbound baggage handling	--	--	34,579	--	34,579
B. Inbound baggage security screening	--	--	--	--	--
C. Baggage claim	--	--	--	--	--
D. Baggage service offices	--	--	--	--	--
7. Hold rooms	--	36,178	--	--	36,178
8. Concessions	--	--	--	--	13,209
A. Food/beverage concessions	--	7,584	--	--	7,584
B. News/gift/specialty retail concessions	--	3,416	--	--	3,416
C. Services	--	189	--	--	189
D. Duty free	--	2,020	--	--	2,020
E. Remote support	--	--	--	--	--
F. Vacant concession	--	--	--	--	--
9. Passenger service	--	--	--	--	9,288
A. Restroom	--	3,353	--	--	3,353
B. Other passenger services	--	5,935	--	--	5,935
10. International arrivals (FIS)	--	--	--	--	--
11. Airport and other agency offices	--	--	--	--	--
A. Port of Seattle	--	--	--	--	--
B. Other agency office/operations support	--	--	--	--	--
12. Public circulation	--	--	--	--	9,619
A. Secure area public circulation	--	--	--	7,195	7,195
B. Non-secure area public circulation	--	--	--	--	--
C. STS guideway	--	--	--	2,424	2,424
13. Building services	--	199	4,643	2,551	7,393
14. Building utilities	9,635	142	2,303	5,146	17,226
15. Rental car	--	--	--	--	--
16. Vacant	--	--	6,889	1,894	8,783
17. Unknown	--	--	1,224	11,652	12,876

Source: Port of Seattle, Terminal Development Strategy, 2012.

Table 3-7  
**Airline Ticketing and Bag Drop Summary**  
 Seattle-Tacoma International Airport

Ticketing zone	Airline(s)	Location	Agent stations	CUSE	Self-serve kiosks	CUSS kiosks	Bag drop	Notes
Zone 1	AMC	Main counter	8	--	--	--	--	
	Asiana	Main counter	6	--	--	--	--	
	British Airways	Main counter	8	--	--	--	--	
	Emirates	Main counter	8	--	--	--	--	Economy check-in.
	Eva	Main counter	6	--	--	--	--	
	Hawaiian	Main counter	6	--	--	--	--	Uses CUSS for self-bag tagging.
	Korean	Main counter	6	--	--	--	--	
	Lufthansa	Main counter	6	--	--	--	--	
	Hainan	Window wall	6	--	--	--	--	
	ANA	Window wall	6	--	--	--	--	
	Emirates	Window wall	8	--	--	--	--	
	Zone 2	Air Canada	Main counter	4	Y	--	4	2
United		Main counter	30	N	34	--	13	
CUSE		Window wall	10	Y	--	--	6	Uses Zone 1 main counter on occasion.
Sun Country			4	--	--	--	--	
Condor			6	--	--	--	--	
Icelandair			4	--	--	--	--	
Zone 3	Delta	Sky priority area	5	N	5	--	--	Sky Priority has five self-serve kiosks and five single agent stations with bag drop.
		General flow thru	16	N	--	--	8	
		Window wall	8	N	28	--	8	
	Virgin America	Main counter	6	N	6	--	3	
	American	Main counter	12	N	12	--	6	
Zone 4	Southwest	Main counter	20	N	18	--	19	Fixed stanchions in front of counters. Two self-serve, no bag check-in kiosks.
Zone 5	American	Main counter	4	N	12	--	4	Open area allows bag drop from self-check.
	JetBlue	Main counter	4	N	--	--	4	
		Window wall	--	N	2	--	--	
	VACANT	Main counter	4	Y	--	--	4	
	Frontier	Main counter	4	N	--	--	4	
Window wall		--	N	4	--	--		



Table 3-7 (page 2 of 2)  
**Airline Ticketing and Bag Drop Summary**  
 Seattle-Tacoma International Airport

Ticketing zone	Airline(s)	Location	Agent stations	CUSE	Self-serve kiosks	CUSS kiosks	Bag drop	Notes
Zone 6	Alaska	Main counter	--	N	39	--	--	5 for First Class/MVP.
		Flow thru	24	N	--	--	48	
		Window wall(1)	5	N	--	--	5	
		Window wall (2)	3	N	--	--	4	
Zone 7	CRUISE	Main counter	6	Y	--	--	--	Manual check in area. Only four terminals.
Bridge 1	CUTE	Promenade/garage	--	--	--	--	1	All Quick Check- In are in garage.
Bridge 2	Delta	Promenade/garage	--	--	3	--	1	All Quick Check- In are in garage.
Bridge 3	Delta	Promenade/garage	--	--	3	--	1	All Quick Check- In are in garage.
Bridge 4	CUTE	Promenade/garage	--	--	--	--	1	All Quick Check- In are in garage.
Bridge 5	Alaska	Promenade/garage	--	--	7	--	1	All Quick Check- In are in garage.
Bridge 6	Alaska	Promenade/garage	--	--	2	--	1	All Quick Check- In are in garage.
Enplane curbside	Alaska	Curb	3	--	--	--	--	
	American	Curb	2	--	--	--	--	
	Delta	Curb	4	--	--	--	--	
	Southwest	Curb	4	--	--	--	--	
	United	Curb	4	--	--	--	--	

Notes:

- Agent Stations = Podium without self-check-in kiosks, but includes bag drop and ticketing computer.
- CUSE = Common Use ticketing stations with LCD monitors.
- Self-serve kiosks = Includes airline specific Self Check-in and boarding pass printing. May or may not be adjacent to dag drop.
- Bag Drop = Includes a position that accommodates bag transfer to airline, may or may not be adjacent to agent or self-check-in kiosks.
- CUSS Kiosks = Includes "Quick" Self Check-in and boarding pass printing for limited airlines. May or may not be adjacent to dag drop.

Source: Port of Seattle, 2014.

Table 3-8  
**Airline Office Areas**  
 Seattle-Tacoma International Airport

Airline	Ticketing Lease Area (s.f.)	Other Lease Area (s.f.)	Total
Alaska Airlines Inc.	196	36,351	36,547
All Nippon Airways	--	1,445	1,445
American Airlines Inc.	1,00	2,127	3,129
Asiana Airlines	--	1,306	1,306
British Airways	--	3,068	3,068
Delta Air Lines Inc.	3,238	18,232	21,470
Emirates Airline	--	1,038	1,038
Eva Airways Corp	--	1,410	1,410
Frontier Airlines	--	701	701
Hainan Airlines Company Ltd.	--	166	166
Hawaiian Air Inc.	--	527	527
JetBlue Airways Corp	912	912	1,824
Korean Airlines	--	549	548
Lufthansa German Airlines	--	747	747
MN Airlines LLC dba Condor Airlines	--	299	299
Port of Seattle (CUSE)	10,640	--	10,640
Southwest Airlines Co.	2,381	3,275	5,656
United Airlines Inc.	2,841	24,265	27,106
US Airways Inc.	1,636	3,742	5,378
Virgin America Inc.	<u>1,327</u>	<u>215</u>	<u>1,541</u>
Total	24,172	100,374	124,546

Note: Other Office Areas includes: Ramp Offices, Baggage Offices, and VIP Offices.

Source: Port of Seattle PROPWORKS database, 2014.

Table 3-9  
**Security Checkpoints**  
 Seattle-Tacoma International Airport

Checkpoint	Location	Pre-security			Processing					TSA staff / office area
		Est. queuing area (s.f.)	Est. queue lanes (s.f.)	Type	No. of service lines	Public processing area	No. of WTD units	No. of WBS units	No. of ETD/BLS stations	
1	ALT. SOUTH, CONC. A & S	1,440	160	PR, G	2	2,284	2	0	2	no
2	SOUTH, CONC. A & B	3,760	940	TSA, PR, G, KC	10	5,371	6	4	6	yes
3	CENTRAL, CONC. B & C	3,840	875	TSA, PR, G	9	8,910	6	3	6	yes
4	CONC. C & D	1,600	360	TSA, PR, G	5	3,594	3	2	3	yes
5	NORTH, CONC. D & N	<u>4,420</u>	<u>1,040</u>	TSA, PR, G, KC	<u>7</u>	<u>10,669</u>	<u>5</u>	<u>2</u>	<u>5</u>	yes
	Total	15,060	3,375		33	30,828	22	11	22	

Notes:

- TSA = TSA pre-check
- PR = Premium
- G = General Passenger
- KC = Known crew
- WTD = Walk thru metal detector
- WBS = Whole body scanner
- ETD/BLS = Electronic trace detection

Source: Record drawings and field review.

Table 3-10  
**Concessionaires**  
 Seattle-Tacoma International Airport

Name	Type	Total Locations (terminal, concourses, and satellites)	Name	Type	Total Locations (terminal, concourses, and satellites)
Bose	Food/beverage	2	LaPisa Café	Food/beverage	1
Discover Puget Sound	News/gift/specialty retail	1	Manchu Wok	Food/beverage	1
Alki Bakery	News/gift/specialty retail	2	Kid Works	News/gift/specialty retail	1
Diva Espresso	Food/beverage	1	Mountain Room Bar	Food/beverage	1
Hudson News	News/gift/specialty retail	14	Seattle Tap Room	Food/beverage	1
Hudson BooksellerRemote support	News/gift/specialty retail	3	The Coffee Bean and Tea Leaf	Food/beverage	1
Kathy Casey Dish D'lish	Food/beverage	2	Casa Del Agave	Food/beverage	1
Massage Bar	Service	1	McDonalds Restaurant	Food/beverage	1
Seattle's Best Coffee	Food/beverage	3	Quiznos	Food/beverage	1
Dufry Duty Free	Duty free	4	Sbarro	Food/beverage	1
Starbucks Coffee	Food/beverage	7	Beecher's Handmade Cheese	Food/beverage	1
Travelex Currency Exchange	Service	4	Butter London	News/gift/specialty retail	1
Pilot House Restaurant	Food/beverage	1	Freshens	Food/beverage	1
Vintage Washington Wine Bar	Food/beverage	1	In Motion Entertainment	News/gift/specialty retail	1
Anthony's Restaurant	Food/beverage	1	Tech On The Go	News/gift/specialty retail	2
Dilletante Chocolate & Mocha Café	Food/beverage	2	The Wishing Stone	News/gift/specialty retail	1
Ex Officio	News/gift/specialty retail	1	Ventures	News/gift/specialty retail	1
Fireworks	News/gift/specialty retail	1	Waji's	Food/beverage	1
Ivar's Restaurant	Food/beverage	1	Wolfgang Puck Gourmet Express	Food/beverage	1
Life Is Good	News/gift/specialty retail	1	Affordable Luxurys	News/gift/specialty retail	1
Maki of Japan	Food/beverage	1	Alaska Lodge	Food/beverage	1
Palino Pastaria	Food/beverage	1	Chili's Too	Food/beverage	1
Qdoba	Food/beverage	1	Sports Page Pub	Food/beverage	1
The Body Shop	News/gift/specialty retail	1	Dungeness Bay Seafood House	Food/beverage	1
Wendy's Restaurant	Food/beverage	1	Kobo	Food/beverage	1
Made in Washington Store	News/gift/specialty retail	1	Runway Grill	Food/beverage	1
Vino Volo	Food/beverage	1	Bigfoot Food & Spirit	Food/beverage	1
Africa Lounge	Food/beverage	1	Burger King Restaurant	Food/beverage	1
Great American Bagel Bakery	Food/beverage	3	Seattle Seahawks 12 Club	Food/beverage	1

Source: Port of Seattle website, 2014.



Table 3-12  
**Outbound Baggage Screening Systems Summary**  
 Seattle-Tacoma International Airport

Ticketing zone	Airlines	EDS Matrix Number	EDS slots available	EDS Matrices		Feed type
				EDS slots active	EDS type	
Pre-Optimization (Multiple EDS Matrices)						
5, 6	American, JetBlue, Frontier, Alaska, Horizon	C1 Screening	10	8	Morpho CTX 9000	Inline
n.a.	International transfer	C25 Screening			Morpho CTX 9000	Inline
2, 3	United, Air Canada, Air Canada Jazz	C60 Screening	8	7	Morpho CTX 9000	Inline
1	International outbound	C61 Screening	3	3	Morpho CTX 9000	Inline
7	None	C88 Screening	4	4	Morpho CTX 9000	Inline
4	Southwest	C96 Screening	4	3	Morpho CTX 9000	Inline
n.a.	North airlines	North Cruise Screening	n.a.	n.a.	Morpho CTX 5500	Standalone
n.a.	South airlines	South Cruise Screening	n.a.	n.a.	Morpho CTX 5500	Standalone
Post-Optimization (Single EDS Matrix)						
1-7	All	Airport-wide	16	11@45 MAP, 15@60 MAP	Morpho CTX 9800 or Smiths HI-SCAN 10080 XCT	Inline

Source: Port of Seattle, 2014.

Table 3-13  
**Inbound Baggage Carousel System Summary**  
 Seattle-Tacoma International Airport

Bag claim	Served airlines	Carousel System						
		Type	Capacity		No. of remote feeds	Length of feed belts	Passenger frontage (s.f.)	Claim area waiting (s.f.)
			Input bags/min.	Passenger estimate				
1	Hawaiian, Sun Country, International	Sloped Plate	50	136	2	80	180	2,340
2	United, Air Canada, Jazz	Sloped Plate	50	136	2	80	180	2,340
3	United, Air Canada, Jazz	Sloped Plate	25	113	1	40	150	1,950
4	Delta	Sloped Plate	25	113	1	40	150	1,950
5	Delta	Sloped Plate	25	113	1	35	150	1,950
6	Delta	Sloped Plate	25	79	1	35	105	1,365
7	Port of Seattle	Sloped Plate	25	87	1	35	115	1,495
8	US Airways	Sloped Plate	25	155	1	65	205	2,665
9	Virgin America/Frontier	Sloped Plate	25	125	1	35	165	2,145
10	Southwest	Sloped Plate	50	128	2	70	170	2,210
11	Southwest	Sloped Plate	25	87	1	35	115	1,495
12	American/Jet Blue	Sloped Plate	25	128	1	70	170	2,210
13	Alaska /Horizon	Sloped Plate	50	134	2	70	177	2,301
14	Alaska /Horizon	Sloped Plate	50	128	2	70	170	2,210
15	Alaska/Horizon	Flat Plate	30	164	None, direct	40	217	2,821
16	Port of Seattle	Flat Plate	30	151	None, direct	40	200	2,600

Source: Port of Seattle, 2014.

# Ground Transportation

## 4.1 Introduction

Figure 4-1 illustrates the location of the Airport – south of the City of Seattle and within the jurisdiction of the City of SeaTac. The Airport is bounded by and is accessible via the state and regional highway network (Interstates 5 and 405, and State Roads [SR] 518 and 509), as well as local roadways (SR 99 / International Boulevard, S. 188<sup>th</sup> St., S. 170<sup>th</sup> St., S. 160<sup>th</sup> St.). SR 518 provides direct access to the multilane North Airport Expressway. The North Airport Expressway also provides local access to Air Cargo Road and S. 170<sup>th</sup> St. via southbound and northbound off-ramps. An on-ramp to the southbound Airport Expressway is provided from Air Cargo Road.

General access to and from the south is provided via signalized intersections at SR 99 / International Boulevard and S. 188<sup>th</sup> St., as well as S. 170<sup>th</sup> St.. Access to airfield services, air cargo, airline operations, and ground transportation facilities located south of the terminal area is provided via 28<sup>th</sup> Avenue and the intersection with S. 188<sup>th</sup> St.

### 4.1.1 Terminal Access

Figure 4-2 illustrates the on-airport roadway system. Vehicles approaching the Airport from the north generally use SR 518 to reach the North Airport Expressway, which provides access to the Main Terminal curbsides, Main Garage, and (via an exit to S. 170<sup>th</sup> St.) remote parking at the Doug Fox Lot. Once inside the terminal area, the North Airport Expressway provides separate access to the Upper Drive, Lower Drive, commercial ground transportation areas on the third floor of the Main Garage, Main Garage, and over height vehicle parking located east of the Main Garage.

Vehicles approaching from the south generally enter the Airport at S. 182<sup>nd</sup> St. and use the northbound North Airport Expressway to either the return-to-terminal ramp near S. 160<sup>th</sup> St. or to S. 170<sup>th</sup> St. (from which they can turn onto Air Cargo Road and then on on-ramp to the southbound North Airport Expressway).

Vehicles exiting the terminal area use the intersection of S. 182<sup>nd</sup> St. and SR 99 / International Boulevard or the northbound North Airport Expressway.

Access to the Rental Car Facility (RCF) is via SR 99 / International Boulevard and S. 160<sup>th</sup> St.. Customers approaching from the north via SR 518 are directed to exit to SR 99 / International Boulevard while customers approaching from the south are us SR 99 / International Boulevard.

Access to facilities located long Air Cargo Road, north of the terminal area, is provided via the North Airport Expressway and an off-ramp to S. 170<sup>th</sup> St., which connects to Air Cargo Road. Vehicles can also reach this section of Air Cargo Road via S. 154<sup>th</sup> St. and other local streets to the north. Vehicles leaving

this section of Air Cargo Road can use S. 160<sup>th</sup> St. or S. 170<sup>th</sup> St. to reach SR 99 / International Boulevard, which connects to the regional freeway system. Access to and from uses located on Air Cargo Road south of the terminal area is via S. 188<sup>th</sup> St., which provides access to SR 99 / International Boulevard, Interstate 5, and SR 509.

The Port has identified a corridor, the “South Access” corridor, to potentially provide direct access to the terminal area from the south. This corridor would provide a connection to a future extension of SR 509.

### 4.1.2 Transit Routes Serving Seattle-Tacoma International Airport

Transit to and from the Airport is provided both by King County Metro (local) and Sound Transit (regional). Figure 4-1 illustrates the various transit routes, park and ride locations, and station locations near the Airport. Table 4-1 lists the routes serving the Airport. SoundTransit routes 560 and 579 pick-up and drop off on the Lower Drive while all King County Metro areas pick-up and drop off on SR 99 / International Blvd., near the light rail station.

The SoundTransit Link Light Rail Station is located east of, and adjacent to, the northeast corner of the Main Garage and is currently the southwestern most station in the network. An extension of the Light Rail line to S. 200<sup>th</sup> St. is currently under construction. This segment’s alignment runs from the existing airport station, follows Air Cargo Road, and 28<sup>th</sup> Ave, and ends at S. 200<sup>th</sup> St.. The S. 200<sup>th</sup> St. station, to be located just west of SR 99 / International Boulevard, will also include a structured parking garage. Eventually the line will extend further south along the International Boulevard corridor.

### 4.1.3 Terminal Area Roadways Traffic Operations

Traffic volume data and level of service assessments will be prepared in the Facilities Requirements. The staff has evaluated future access to SR 509 and a tentative plan exists for future planning efforts.

### 4.1.4 Parking

#### 4.1.4.1 On-Airport Parking Facilities

Figure 4-4 illustrates the locations of various parking facilities serving passengers and employees. On-airport public parking locations are shown in Figure 4-4 and referenced in Table 4-2 and Table 4-3.

As indicated in Table 4-2, the terminal parking garage currently provides parking for nearly 13,000 vehicles, with approximately 11,000 spaces allocated for public parking. The Port also provides a parking area for over height and larger vehicles located east of the Main Garage exit plaza and is estimated to accommodate 95 vehicles. Access to this lot is via either the North Airport Expressway or the S. 182<sup>nd</sup> St. airport entrance. The garage also provides space for permitted employee parking on Level 1 with an estimated 700 spaces.

In addition to the parking garage, the Port maintains a 1,620 stall on-airport lot north of S. 170<sup>th</sup> St.. This lot is leased and operated as the Doug Fox Parking lot, with shuttle service provided on a regular basis.

The Port provides a 250-space cell phone parking lot just south of S. 170<sup>th</sup> St., between the northbound and southbound lanes of the Airport Expressway.



#### **4.1.4.2 Employee Parking**

Terminal-employee parking is provided in the Main Garage on Floor 1 and the North Employee Parking Lot (NEPL). The garage allocates approximately 690 spaces while NEPL has an allocated capacity of 4,100 spaces. The Port provides shuttle service to and from the NEPL via a route along Air Cargo Road to the parking garage service tunnel. The route provides two stops along Air Cargo Road and then two other stops at each end of the service tunnel adjacent to Main Garage Floor 1. Parking is also provided on individual tenant lease holds in the north and south air cargo areas, general aviation area, S. 28<sup>th</sup> Ave. logistics area, Swissport, USA Inc. (Swissport) Fueling (tank farm), Delta and Alaska hangars, and several other small locations. The toll plaza area adjacent to the Main Garage also contains spaces for permitted parking and landside operations staff. Table 4-3 summarizes the available data related to employee parking.

#### **4.1.4.3 Off-Airport Parking**

The City of SeaTac and City of Burien are home to approximately 19,000 available vendor provided parking spaces. Of these, approximately 14,300 are available for airport related parking with the remainder serving hotel/motel customers. Figure 4-5 illustrates the location of on-airport vendor-provided spaces and Table 4-4 summarizes the parking capacity at all 35 off-airport public parking locations serving Airport passengers.

#### **4.1.5 Commercial Ground Transportation Services**

Commercial Ground Transportation Services are provided on Level 3 of the Main Garage, the South GT Lot, and the North Charter Lot. Figure 4-3 depicts the locations and capacities of services using Level 3 of the Main Garage.

##### **4.1.5.1 Courtesy Vehicles**

Courtesy vehicle service is offered by 18 off-airport parking operators, 17 hotel/motels that also offer off-airport parking, and 48 other hotel/motels. As shown on Table 4-5, these operators provided over 1.2 million courtesy vehicle trips to the Airport in 2013. Courtesy vehicles pick up and drop off passengers on both a scheduled and on-demand basis from the 3<sup>rd</sup> Floor Courtesy Vehicle Drive. Figure 4-3 illustrates the layout of the three “courtesy islands” which are identified from north to south. Islands 1 and 3 serve hotels and parking shuttle services while Island 2 caters to Downtown Airporter services. Island 3 is also designated for airline crew shuttles. The Courtesy Drive also provides access at both north and south ends for motorcycle parking.

##### **4.1.5.2 Taxicabs, Limousines, and Shared-ride Vans**

Taxis, limousines, and shared-ride vans pick up passengers on Level 3 of the Main Garage in locations identified on Figure 4-5. In addition to the passenger loading areas, taxis use 70 staging spaces at the north end of Level 3 of the Main Garage. Table 4-6 summarizes the traffic volumes for these operations for calendar year 2013.

##### **4.1.5.3 Scheduled and Charter Services**

Currently, eleven scheduled bus operators (“Airporters”) serve the Airport, providing bus and van services. These services, summarized on Table 4-7, load passengers in the South GT Lot. In addition, Kenmore Air provides shuttle service between the South GT Lot, Boeing Field, and their Lake Union terminal.

Between April and October, the Airport accommodates charter buses carrying passengers and baggage between the Airport and cruise ships berthed at downtown Seattle and Vancouver, BC. In 2014, these charter buses dropped off passengers (sea-to-air passengers) at the north end of the Upper Drive and picked up passengers (air-to-sea passengers) in the South GT Lot using 22 bus parking positions. In prior years, these charter buses dropped off passengers in the North Charter Lot (providing 7 bus parking positions), adjacent to Concourse D, which remains available for this use.

##### **4.1.5.4 Ground Transportation Support Areas**

As a support to ground transportation providers, the Airport provides two ground transportation hold lots. One is located on the south side of S. 160<sup>th</sup> St. opposite the Consolidated Rental Car Facility. This 2.5-acre lot provides queuing and rest service time for taxis and limousines prior to their entry into the 3<sup>rd</sup> floor of the garage. The second area is located off S. 28<sup>th</sup> Avenue, west of S. 188<sup>th</sup> St.. This 1.2-acre area is used for queuing of Airporters and Cruise charter buses prior to entry into the South GT Lot.

##### **4.1.6 Consolidated Rental-Car Facility**

In 2011 the Port opened the Consolidated Rental Car Facility (RCF) located west of International Boulevard and north of S. 160<sup>th</sup> St.. This five-level facility provides all customer service, ready/return, and quick turn-around service areas for all on-Airport rental car operators. Table 4-8 provides data relative to the space allocations for the RCF. Table 4-9 provides a description of fueling and washing within the designated QTA spaces.

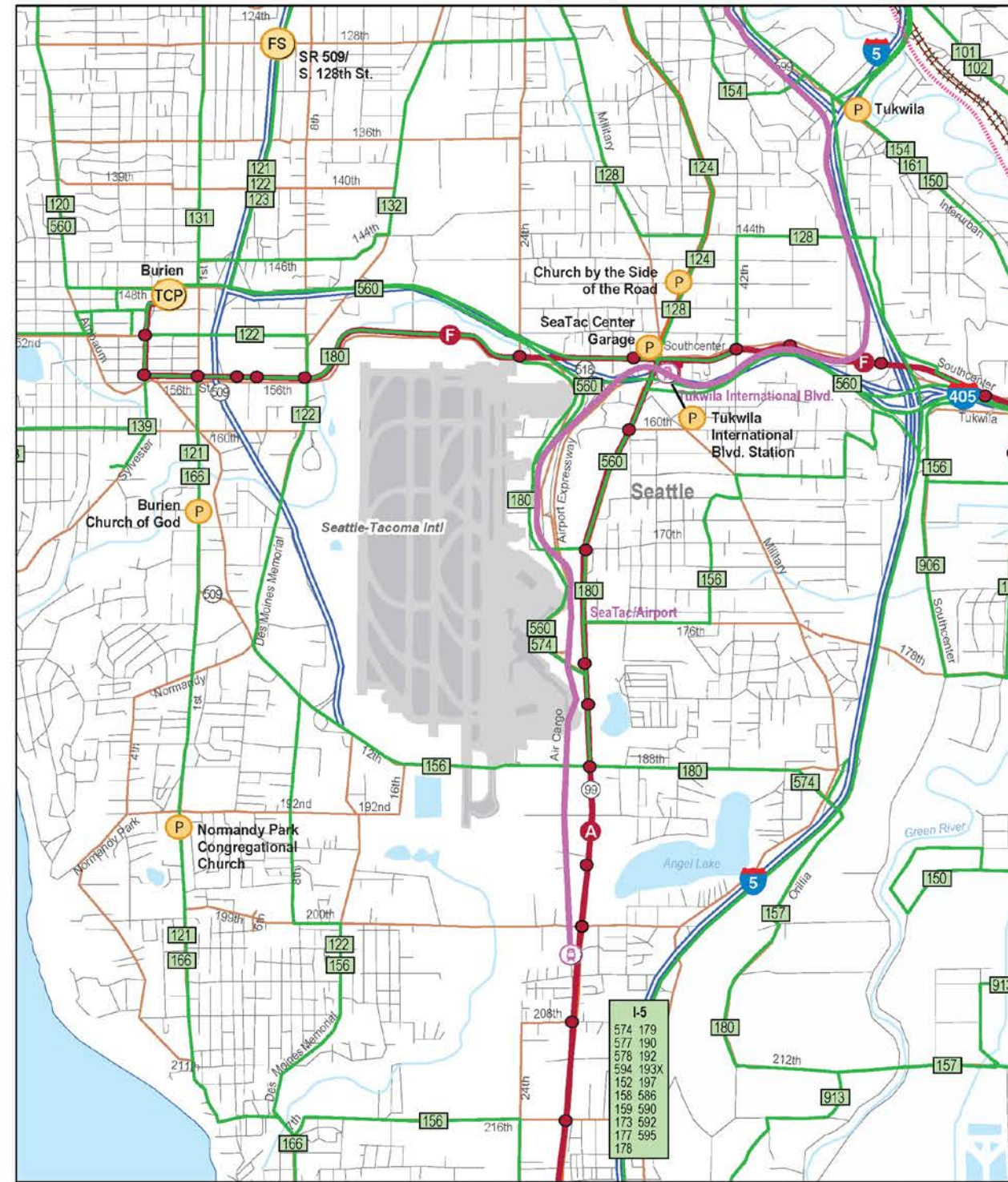
The Port believes that this facility will accommodate the needs of the current rental car companies through a level of approximately 57 million annual passengers.

Passengers travel between the terminal and RCF via Port-operated buses that deliver and pick up passengers at locations on the north and south ends of the Lower Drive. To do so, the Port maintains a fleet of 29 40-foot long compressed natural gas (CNG) fueled buses. These operate on a defined schedule at 5-minute headways during peak periods.

##### **4.1.7 Bus Maintenance Facility**

The Port operates a consolidated vehicle maintenance facility for buses on a 6.2 acre site adjacent to its CNG fueling station located west of S. 28<sup>th</sup> Avenue. This facility provides bus fueling, maintenance, and wash services for the employee bus fleet and RCF fleet operations. Table 4-10 provides a functional spatial description of the facility.

Figure 4-1  
 Vicinity Map and Public Transportation Routes  
 Seattle-Tacoma International Airport



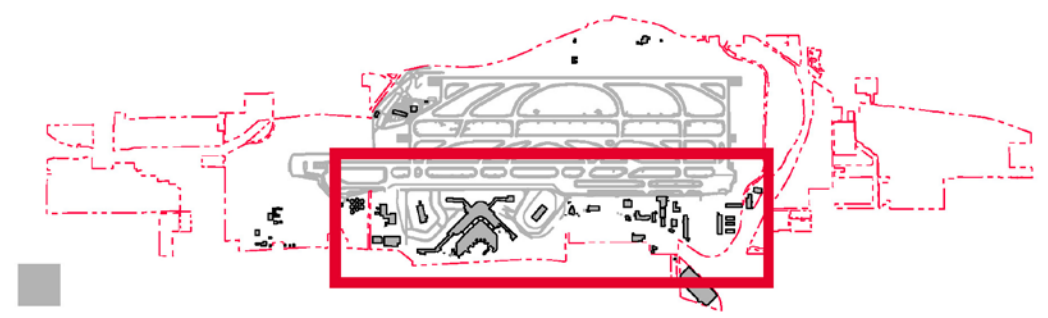
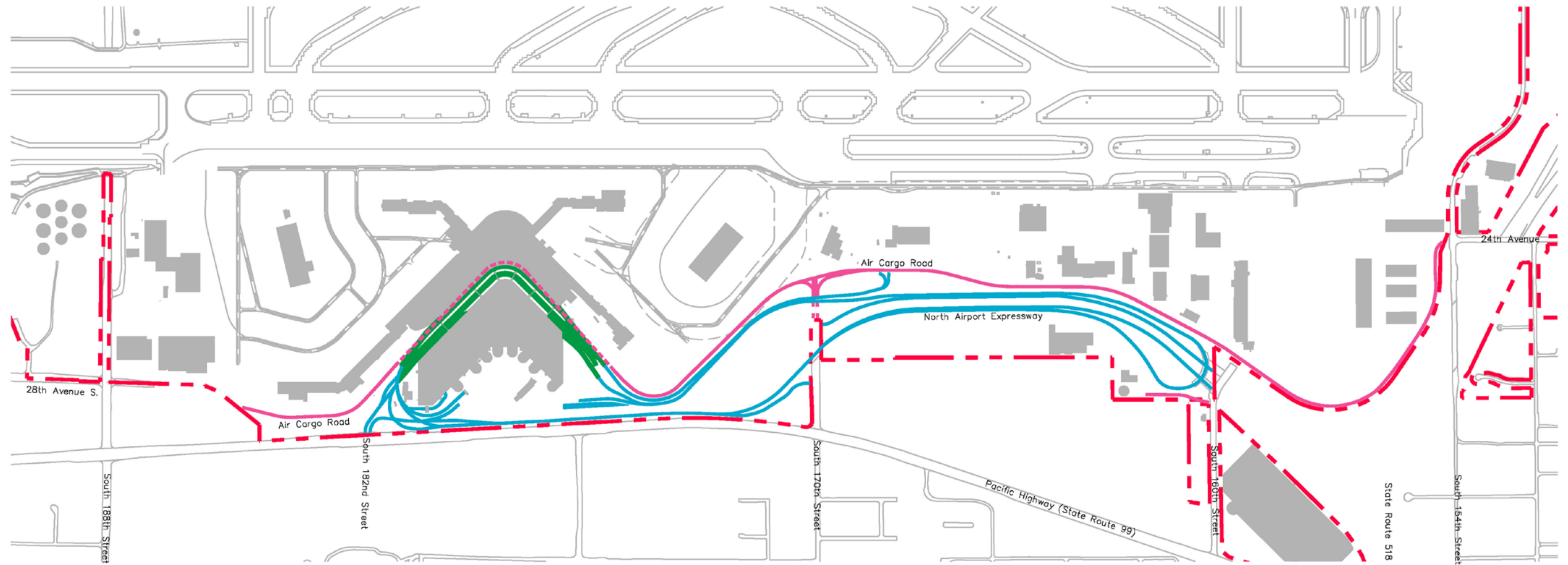
**LEGEND**

- Central Link light rail line and station
- Sounder commuter rail line and station
- RapidRide line and stop
- Bus route
- Transit center and park & ride
- Freeway station
- Park & ride

0 .35 .70 1.40 miles

Source: LeighFisher, updated June 2017

Figure 4-2  
**On-Airport Roadway System**  
 Seattle-Tacoma International Airport



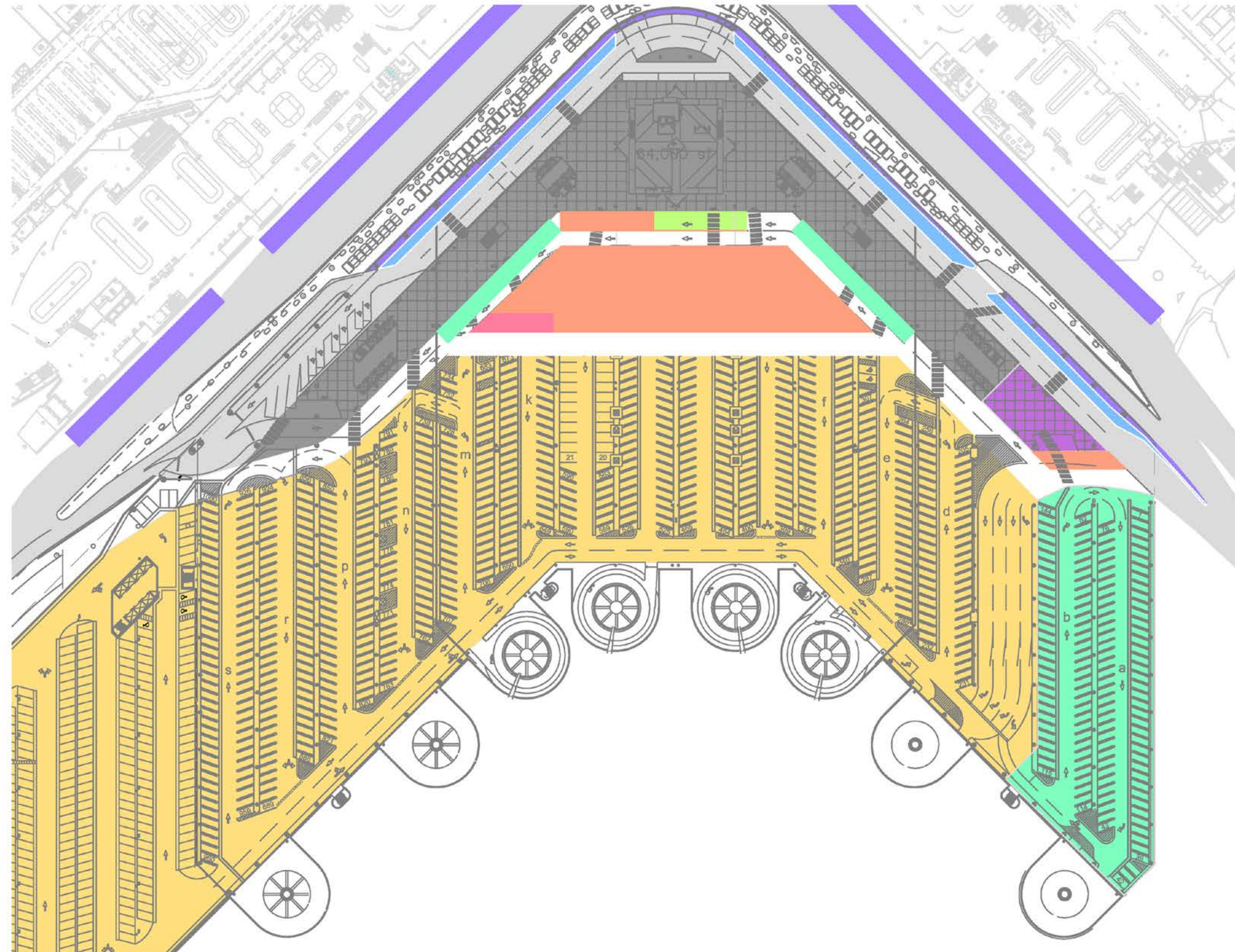
**LEGEND**

- Curbside
- Access and circulation
- Service roads
- Airport buildings
- Airport property line
- Service road tunnel

0 800 1600 ft.

Source: Airport Layout Plan (December 2007)

Figure 4-3  
**Curbside Ground Transportation (Garage Level 3)**  
 Seattle-Tacoma International Airport



- LEGEND**
- General parking
  - Shuttle express (8 spaces)
  - Limo area (50 spaces)
  - Delivery – permit (4 spaces)
  - Taxi loading (13 spaces) and staging (70 spaces)
  - Roadways
  - Motorcycle parking
  - Courtesy islands (22 spaces)
  - Pedestrian circulation plaza
  - Curbside



Source: Shen Consulting on-site verification

Figure 4-4  
**Airport-Related Parking Facilities**  
 Seattle-Tacoma International Airport

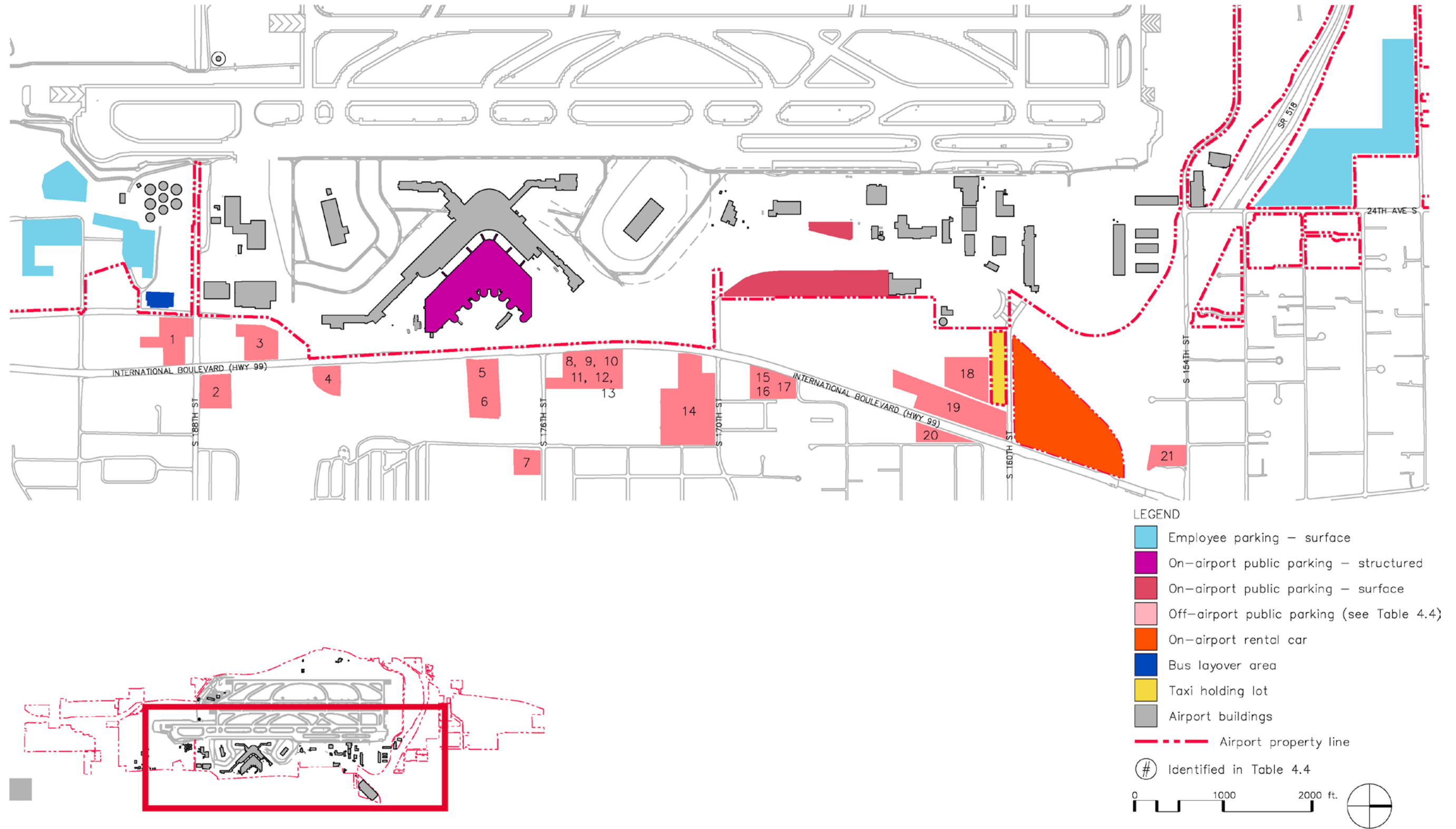


Table 4-1  
**Transit Routes Serving the Airport**  
 Seattle-Tacoma International Airport

Route	Station location	Origin – Destination	Frequency (a)
Metro 124	Tukwila Station	Downtown Seattle – Tukwila Station	98
Metro 128	Tukwila Station	West Seattle – Southcenter	78
Metro 140	Tukwila Station	Burien TC – Renton TC	118
Metro 156	International Blvd.	Highline Community College – Southcenter	64
Metro 180	International Blvd.	Southeast Auburn – Burien TC	82
Metro Rapidride A	International Blvd.	Federal Way TC – Tukwila Station	182
Link Light Rail	Airport	Seattle – Seattle-Tacoma International Airport	
Sound Transit 560	Lower Drive Station	West Seattle – Bellevue	67
Sound Transit 574	Lower Drive Station	Lakewood – Seattle-Tacoma International Airport	77

(a) Number of trips per day, both directions combined.

Source: Port of Seattle, 2014.

Table 4-2  
**Airport Owned Public Parking**  
 Seattle-Tacoma International Airport

Parking area	Allocated spaces (vehicles)						Port of Seattle maintenance, service, fleet	Other/ out of service	Total	Notes
	Public	Public/ADA	Private		Empl./ADA					
			Elec. veh.	Employee						
Terminal parking garage										
Floor 8	1,776	--	--	--	--	--	--	1,776		
Floor 7	1,838	--	--	--	--	--	--	1,838		
Floor 6	1,850	--	--	--	--	--	--	1,850		
Floor 5	1,660	112	36	--	--	--	--	1,808		
Floor 4	1,258	24	12	--	--	--	--	1,294	Terminal direct access only.	
Floor 3	924	--	--	--	--	--	--	924	Plus taxis, limos, shuttles.	
Floor 2	1,587	--	--	--	--	--	--	1,587		
Floor 1	--	--	4	664	19	--	900	1,587	Estimated.	
Sub	--	--	--	--	--	83	--	83	Verify use/capacity.	
Total	10,893	136	52	664	19	83	--	12,747		
Overheight vehicle area	89	6	--	--	--	--	--	95		
Toll Plaza Area (NR) (a)	5	2	--	25	2	--	--	34	Public space is for toll plaza customer service.	
Cell Phone Lot (NR)	250	--	--	--	--	--	--	250		
S. 170th St. Lot (Doug Fox) (b)	1,620	--	--	--	--	--	--	1,620		

Notes:  
 (a) Includes service area parking under bridge structure  
 (b) Operated via lease with Port by ATZ Inc.  
 NR = Non-Revenue

Source: Port of Seattle, 2014.

Table 4-3  
**Employee Parking Summary**  
 Seattle-Tacoma International Airport

Location	Allocated spaces			Total	Security/access control type	Shuttle service
	Employee Vehicles	ADA	Reserved restricted use			
North employee parking lot	4,094	TBD	n.a.	4,094	Yes	Port
Air cargo areas	TBD	TBD	TBD	0	No	No
Terminal parking garage	664	19	83	766	Access	No
South employee parking lot	1,091	n.a.	n.a.	1,091	Inactive	Inactive
Toll plaza	25	2	n.a.	27	No	No

Source: Port of Seattle Aviation Planning, 2014.



Table 4-4  
**Off-Airport Parking Capacity**  
 Seattle-Tacoma International Airport

Location number (See Figure 4-5)	Vendor	Surface lot/ Garage	Estimated Capacity	Estimated Capacity for Airport parking	Shuttle
1	MVP Airport Parking	Lot	362	362	Y
2	Doubletree Inn Seattle Airport	Lot	852	170	Y
3	WallyPark, Premier Garage	Garage	1,600	1,600	Y
4	MasterPark, Lot A	Lot	441	441	Y
5	WallyPark, Self-Park Lot 2	Lot	319	314	Y
6	WallyPark, Valet-Only	Lot	806	806	Y
7	Marriott Hotel Seattle Airport	Garage	529	n.a.	Y
8	Clarion Hotel Seattle Airport	Lot	253	51	Y
9	Park N Fly Seattle	Lot	293	293	Y
10	Holiday Inn Seattle Airport	Garage	219	44	Y
11	Rodeway Inn	Lot	75	15	Y
12	Jet Motel	Lot	313	63	Y
13	Sea-Tac Inn & Airport Parking	Lot	116	23	Y
14	MasterPark, Lot B	Lot	2,237	2,237	Y
15	Red Roof Inn Seattle	Lot	52	10	Y
16	MasterPark, Valet Garage	Garage	1,000	1,000	Y
17	Ramada Inn & Suites SeaTac	Lot	132	26	Y
18	MPark	Lot	660	n.a.	Y
19	MasterPark, Lot C	Lot	1,337	1,337	Y
20	Extra Car Airport Parking	Lot	359	359	Y
21	Ajax Parking, Lot 1	Lot	185	185	Y
South of Figure					
	Americas Best Value Inn	Lot	216	43	Y
	Skyway Inn Airport Parking	Lot	295	59	Y
	SeaTac Park.com	Lot	1,162	1,162	Y
	Sandstone Inn Airport Parking	Lot	379	76	N
	Super 8 Motel	Lot	295	59	Y
	Thrifty Car Rental	Lot	924	924	Y
	Sea-Tac Crest Motor Inn	Lot	140	28	Y
	Aeroparking	Lot	380	n.a.	Y
East of Figure					
	E-Z Airport Parking	Lot	453	453	N
	ShuttlePark2	Lot	1,051	1,034	Y
	Knights Inn SeaTac Airport	Lot	36	n.a.	Y
North of Figure					
	Ajax Parking, Lot 2	Lot	701	733	Y
	Park N Jet, Lot 2	Lot	459	n.a.	Y
West of Figure					
	Park N Jet, Lot 1	Lot	438	438	Y
Total			19,069	14,345	

Notes:  
 n.a. = not available.

Source: Port of Seattle, 2014.

Table 4-5  
**Monthly Courtesy Vehicle Trips 2013 – Parking, Hotels, Downtowners**  
 Seattle-Tacoma International Airport

	Jan	Feb	Mar	Apr	May	Jun	Jul	Aug	Sep	Oct	Nov	Dec	Total	Average	
														Month	Day
Parking vendors	63,564	60,606	67,191	66,884	68,570	64,172	62,984	63,086	60,409	66,325	59,897	60,612	764,300	63,692	2,094
Hotel/motel (a)	36,996	33,694	40,395	36,674	42,870	45,861	46,999	47,179	46,795	39,536	35,995	38,681	491,675	40,973	1,347
Downtown vans	<u>319</u>	<u>311</u>	<u>378</u>	<u>429</u>	<u>488</u>	<u>524</u>	<u>664</u>	<u>688</u>	<u>625</u>	<u>261</u>	<u>329</u>	<u>449</u>	<u>5,465</u>	<u>455</u>	<u>15</u>
<b>Total</b>	<b>100,879</b>	<b>94,611</b>	<b>107,964</b>	<b>103,987</b>	<b>111,928</b>	<b>110,557</b>	<b>110,647</b>	<b>110,953</b>	<b>107,829</b>	<b>106,122</b>	<b>96,221</b>	<b>99,742</b>	<b>1,261,440</b>	<b>105,120</b>	<b>3,456</b>

Notes:

(a) Includes hotel/motel operators also providing off-Airport parking.

Source: Port of Seattle, 2014.

Table 4-6  
**Monthly Door to Door Services Trips 2013 – Taxis, Limousines, Shuttles**  
 Seattle-Tacoma International Airport

	Jan	Feb	Mar	Apr	May	Jun	Jul	Aug	Sep	Oct	Nov	Dec	Total	Average	
														Month	Day
Crew vans	3,395	3,084	3,507	3,477	2,900	1,821	1,877	1,814	1,830	1,343	1,539	1,603	28,190	2,349	77
Taxis	57,479	51,529	59,916	63,083	66,090	68,269	68,213	65,774	67,418	64,577	56,482	54,969	743,799	61,983	2,038
Limousines	8,107	7,451	8,911	9,359	10,844	11,456	11,778	12,084	11,666	11,263	9,605	9,229	121,753	10,146	334
Shuttles	<u>5,228</u>	<u>4,356</u>	<u>5,116</u>	<u>5,304</u>	<u>6,066</u>	<u>5,790</u>	<u>5,964</u>	<u>5,985</u>	<u>5,342</u>	<u>4,933</u>	<u>4,449</u>	<u>5,336</u>	<u>63,869</u>	<u>5,322</u>	<u>175</u>
<b>Total</b>	<b>74,209</b>	<b>66,420</b>	<b>77,450</b>	<b>81,223</b>	<b>85,900</b>	<b>87,336</b>	<b>87,832</b>	<b>85,657</b>	<b>86,256</b>	<b>82,116</b>	<b>72,075</b>	<b>71,137</b>	<b>957,611</b>	<b>79,801</b>	<b>2,624</b>

Source: Port of Seattle, 2014.

Table 4-7  
**Scheduled Airporter Routes**  
 Seattle-Tacoma International Airport

Operator name	Destination
Bellair Airport Shuttle	Alaska Ferry Terminal, Anacortes, Bellingham, Blaine, CleElum, Ellensburg, Ferndale, LaConner, Marysville, Mt. Vernon, Stanwood, Yakima
Bremerton-Kitsap	Bangor, Bremerton, Gig Harbor, Gorst, Port Orchard, Poulsbo, Purdy, Silverdale, NW Tacoma
Capital Airporter	Auburn, Bonney Lake, Centralia, Chehalis, Federal Way, Fife, Kent, Lacey, Lakewood, Olympia, Parkland, Puyallup, Shelton, Steilacom, Tacoma, Tumwater, Union
Ft. Lewis-McChord	Joint Base Lewis McChord
Island Airporter	San Juan Island
Olympic Bus	Port Angeles, Sequim, Port Townsend, Discovery Bay, Kingston
Quick Shuttle	Vancouver, B.C.
Vashon	Vashon Island
Wenatchee Valley	Wenatchee
Whidbey- SeaTac	Whidbey Island

Source: Port of Seattle, 2014.

Table 4-8  
**Rental Car Facility Summary**  
 Seattle-Tacoma International Airport

Floor	Tenant	Space Allocation (s.f.)			Total
		Customer service	Ready/return	QTA (a)	
1st	Dollar		76,791	14,708	91,499
	EAN		30,924	0	30,924
	Fox		50,957	5,655	56,612
	Thrifty		67,301	15,660	82,961
	Small Operator(s)		31,958	5,803	37,761
	Common/Reserve		55,169	53,511	<u>108,680</u>
Subtotal					408,437
2nd	AVIS Budget		266,323	39,432	305,755
	Common/Reserve		52,620	0	<u>52,620</u>
Subtotal					358,375
3rd	Hertz		225,727	34,647	260,374
	Simply Wheelz		31,538	6,046	37,584
	Common/Reserve		56,486	50,476	<u>106,962</u>
Subtotal					404,920
4th	EAN		267,376	38,667	306,043
	Common/Reserve		52,508	40,366	<u>92,874</u>
Subtotal					398,917
1st & 5th	Small Operator(s)	1,439	31,958	5,803	<u>39,200</u>
Subtotal					39,200
5th	AVIS Budget	8,573			8,573
	Dollar	2,622			2,622
	EAN	9,541			9,541
	Fox	2,068			2,068
	Hertz	8,345			8,345
	Simply Wheelz	1,401			1,401
	Thrifty	2,119			2,119
	Small Operator(s)	1,423			1,423
	Common/Reserve	24,688			<u>24,688</u>
Subtotal					60,780
Total					1,670,629

Notes:

QTA = Quick turnaround area

EAN = Enterprise, Alamo, National

Additional land space is used for vehicle storage on a parcel north of the main facility. This area includes 32,330 s.f. of leased space and 20,578 s.f. of common area.

Source: Port of Seattle, 2014.

Table 4-9  
**Quick Turnaround Area Detail**  
 Seattle-Tacoma International Airport

Floor	Tenant	Wash bays	Fuel pumps
1st	Dollar	2	9
	Fox	1	3
	Thrifty	2	9
	Small Operator(s)	<u>1</u>	<u>3</u>
	Subtotal	6	24
2nd	AVIS Budget	5	24
3rd	Hertz	4	21
	Simply Wheelz	<u>1</u>	<u>3</u>
	Subtotal	5	24
4th	EAN (a)	<u>5</u>	<u>24</u>
	Total	21	96

Notes:  
 QTA = Quick turnaround area  
 EAN = Enterprise, Alamo, National.  
 (a) See Table 4-10 for summary of QTA equipment.

Source: Port of Seattle, 2014.

Table 4-10  
**Bus Operations Summary**  
 Seattle-Tacoma International Airport

Location/Site	Total gross area (s.f.)	Spaces			Fleet size	Operations
		Parking spaces	ADA	Reserved restricted use		
Bus Maintenance Facility	6.16 acres	--	--	--	--	
Maintenance Bays/Work Area	8,880	--	--	--	--	
Fueling	2,016	--	--	--	--	4 fuel dispensers
Wash Rack	8,520	--	--	--	--	Including 1320 s.f. internal chassis wash bay
Office Space	3,924	--	--	--	--	
Employee Space	3,242	--	--	--	--	15 Fleet Maintenance Employees plus Drivers
Storage Space	698	--	--	11	--	
Parts/Supplies	2,032	--	--	--	--	
Mech./Elec. Rooms	474	--	--	--	--	
Bus Parking	--	42	--	--	--	
Employee Parking	--	151	4	9	--	9 low emission vehicle spaces
Fleet Description						
Employee Busing	n.a.	n.a.	n.a.	n.a.	16	3 buses operate 24/7. An express bus is added between 1:30 and 3:30 PM
Rental Car Busing	n.a.	n.a.	n.a.	n.a.	29	29, 40' CNG buses. The buses operate on a defined schedule with a single loop (buses stopping at both north and south) until 9am. The operation then transitions to the dual loop where buses are assigned to either the north stop or the south stop only until 2pm. All buses stop to drop off at the RCF Arrivals and Departures curb. Our service level metric is to provide buses on a 5 minute headway basis during busy times. Average occupancy per bus is provided in the spreadsheet as well as numbers of buses in service and the passenger volumes for a given hour.

Source: Port of Seattle Record Drawings, 2014.

# Air Cargo

## 5.1 Introduction

As shown in Figure 5-1, air cargo facilities are located in proximity to ramp areas both north and south of the terminal area. Total ground lease area designated for cargo tenants is nearly 2.6 million s.f. (59.6 acres). Within these locations, areas are designated as Cargo 1 to Cargo 7. To the south lies Cargo 7, which consists of the Swissport Air Cargo building. Not all tenants are ramp dependent. North of the terminal lies Cargo 1, which consists of one building with Federal Express as the main tenants. The area adjacent to AMB 1 is not used for cargo activities as Horizon Air uses it for RON aircraft. The Cargo 2 area consists of four cargo buildings and ramp loading space capable of accommodating four widebody air cargo aircraft. Cargo 3 area is leased to FedEx; their ramp can support three widebody aircraft along six positions.

This area is also used by the numerous FedEx feeder aircraft, which are typically small jets or turbo prop aircraft (Aircraft Design Group II). Cargo 4 serves AMP 4 but primarily Alaska Cargo uses this ramp area. Cargo 5 is currently under construction at the site of the former US Post office facility and will provide nine acres of new ramp area, targeted for use as RON aircraft parking. Cargo 6 is approximately 2.6 acres in area and accommodates five aircraft parking positions. The Cargo 7 ramp area provides 4.7 acres of RON aircraft parking but may be used in the future as an active passenger unloading area for international flights that cannot be accommodated at the South Satellite. This area also provides storage from ground service equipment.

Table 5-1 defines the air cargo building sizes and characteristics. Additional information relative to each building layout and current spatial functions is available.

### 5.1.1 Cargo Warehouses

The locations of air cargo warehouse facilities and ramp areas are shown on Figure 5-1. The space utilized for air cargo in each of the cargo facilities identified in Figure 5-1 is summarized in Table 5-1. The following paragraphs summarize the uses and tenants of the warehouses as of Fall 2014. The paragraphs are organized according to building number, with the building's primary tenant shown in parenthesis.

- Building #1 (FedEx heavy freight and USPS outbound mail facility) – Building #1, a 51,720 sq. ft. warehouse, is occupied by two tenants. FedEx leases 15,000 square feet in Building #1 (AMB 1) in which it operates a secondary facility for its heavy freight. The remainder of the building is used by USPS for outbound mail (Matheson is the USPS service provider).
- Building #2, also referred to as Transplex Building A (Hanjin) – Building #2, an 84,000 sq. ft. warehouse is used for two functions, one unrelated to air cargo. Hanjin, a third party

cargo service provider, utilizes 23,600 sq. ft. of Building #3 to handle Korean Airlines, Lufthansa, and occasionally Continental Airlines and UPS (for weather diverted flights). The remaining part of the Building #3 is used for GSE maintenance and for stores.

- Building #3, also referred to as Transplex Building E (Worldwide Flight Services) – Building #3, a 25,000 sq. ft. warehouse, is occupied by Worldwide Flight Services (WFS). WFS has recently lost some of its major customers, which caused them to relocate from Building #12 to their current location. WFS handles relatively small quantities of cargo for US Airways and American Airlines. Building #3 is outside the Air Operations Area (AOA).
- Building #5, also referred to as Transplex Building G – Building #5, 25,000 sq. ft., is operated by Matheson, who provides inbound mail sorting services for USPS. Building #5 is outside the AOA.
- Building #6 (FedEx) – FedEx accommodates all but its heavy freight activity in Building #6, a 73,250 sq. ft. warehouse adjacent to Cargo 3 (at the Airport, any ramp area where cargo aircraft may be parked is designated as a numbered cargo ramp) with a second operation for heavy freight in Building #1, adjacent to Cargo 1.

FedEx has direct AOA access. The FedEx facility in Building #6 is contiguous to common use ramp (i.e., Cargo 3) with priority parking for FedEx aircraft. The ramp provides hardstands able to accommodate up to five B-777 aircraft.

- Building #7 (Bolanos) – Building #7 is a 35,100 sq. ft., warehouse owned by Bolanos and operated by Summit NW as container freight station for a trucking company and as a cargo screening center. Building #7 is outside the AOA.
- Building #8 (Cargo Airport Services) – Building #8 is a 48,520 sq. ft., warehouse leased by Prologis and operated by Cargo Airport Services (CAS), a third party service provider. The entire building area is used for cargo. CAS handles Cargolux, Emirates, Asiana (both passenger and freighter flights), British Airways, Hainan Airlines, Icelandair, Evergreen International Airlines, Sun Country Airlines, and JetBlue.

The facility has direct AOA access and services two freighter operators by tug because its facility has no dedicated ramp.

- Building #9 (BT) – Building #9 is a 14,960 sq. ft. warehouse owned by BT and operated by the freight forwarder UPS Supply Chain Solutions as offices.
- Building #10 (Southwest Airlines) – Southwest Airlines' cargo operation is located in Building #10, a 25,700 sq. ft. warehouse adjacent to Cargo 4. The building accommodates Southwest, the building's only cargo tenant (11,000 sq. ft.), and a provisioning operation.

The facility has direct AOA access, no dedicated ramp, and a tug alley to access the main vehicle service road.

- Building #11 (Alaska Airlines) – Alaska Airline’s cargo operation is located in Building #12, a 68,730 sq. ft. warehouse. The facility has freezer and cooler space for perishables, supporting the carrier's Alaska seafood shippers. In addition to its own cargo, Alaska also handles Horizon air cargo. The facility has direct AOA access and an adjacent dedicated ramp (Cargo 4) which is able to simultaneously accommodate two B737-400 aircraft.
- Building #12 (Airport) – Building #12, a 49,260 sq. ft. warehouse, is the former United Airlines cargo facility. The building is owned by the Airport, vacant, and in need of repairs.

The building is adjacent to Cargo 4 and is the only empty facility in the cargo area controlled by the Airport.

- Building #13 (Swissport) – Building #13, a 31,560 sq. ft. warehouse, is leased by Prologis and operated by Swissport, a third party service provider. Swissport handles China Airlines, EVA Airways, All Nippon Airways, Condor, Hawaiian Airlines, United Airlines, and Frontier.

The facility has direct AOA access and an adjacent dedicated ramp (Cargo 6) which is able to simultaneously accommodate five B777 aircraft.

- Building #14 (Delta Air Lines) – Delta’s cargo operation is in the Airport’s newest cargo facility, a 58,000 sq. ft. warehouse built in 2000, and the only cargo facility at the Airport's south end. The facility has direct AOA access and was designed for a B747-200 freighter operation which Delta does not operate, so many features go unutilized. Delta uses only half of its landside doors and uses its freighter parking ramp for container storage and overnight aircraft parking.

### 5.1.2 Cargo Hardstands

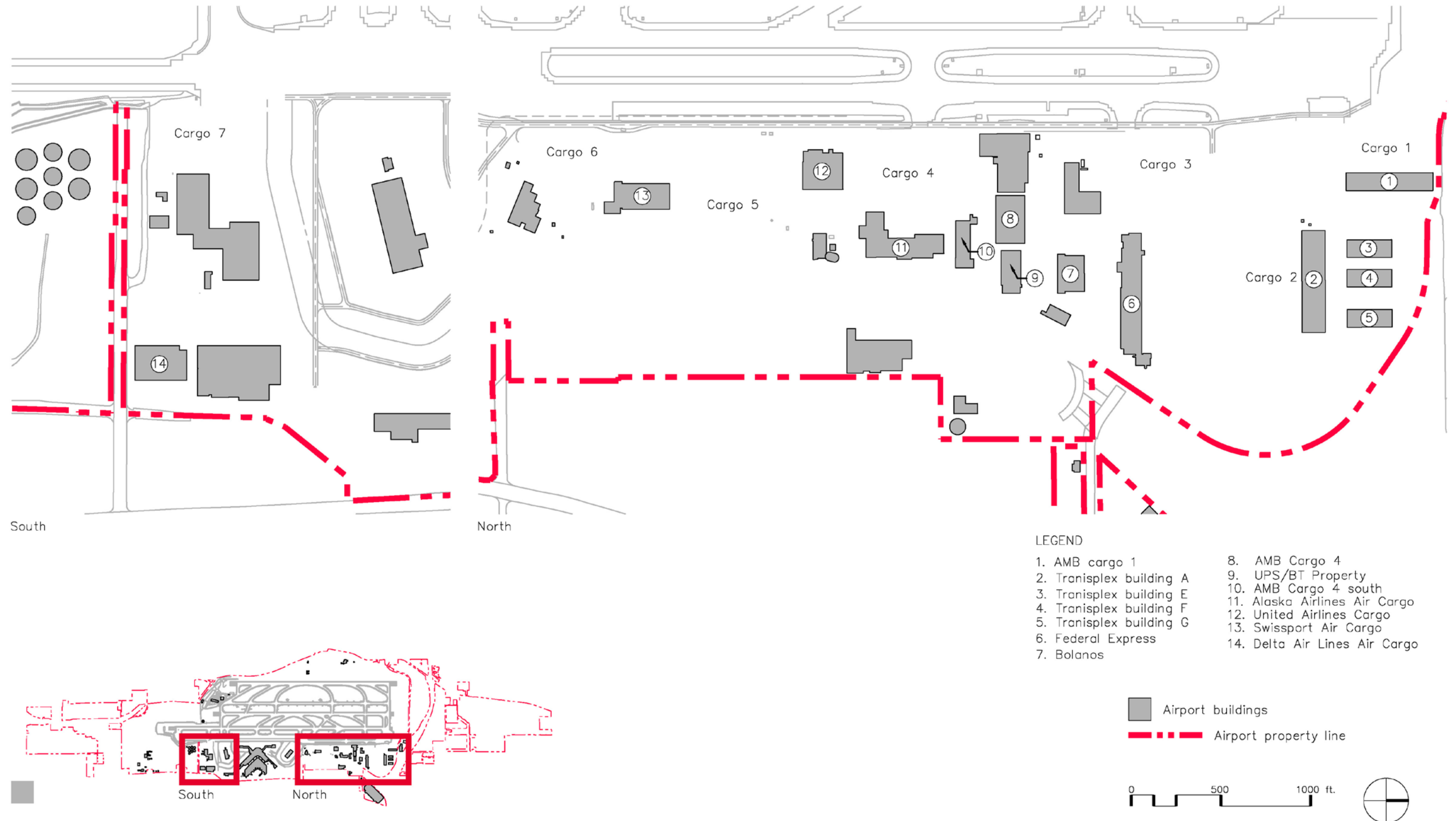
Aircraft hardstands used by cargo aircraft are located on five ramp areas, designated Cargo 2 through Cargo 6. Two other designated ramp areas, Cargo 1 and Cargo 7, are not used by cargo aircraft. Cargo 1 is used for equipment only and Cargo 7 is used for remain overnight aircraft. The cargo aircraft parking capabilities of the five ramp areas used by cargo aircraft are summarized below:

- Cargo 2 – Cargo 2 has three B747-8F cargo aircraft parking positions.
- Cargo 3 – Cargo 3 provides parking positions for five aircraft: two B777F, two MD11F, and one MD10F.
- Cargo 4 – Cargo 4 provides parking positions for four aircraft, two of which are part of Alaska’s leasehold: two B737-400 aircraft on the airside of Building #11 (Alaska’s exclusive positions), and two B767-300 aircraft.
- Cargo 5 – Cargo 5 provides the capability to park three B747-400 cargo aircraft.
- Cargo 6 – Cargo 6 provides the capability to park two B747-8F aircraft.

In addition to the capability to park cargo aircraft described above, Delta has the ability to park two B747-8F cargo aircraft within the Delta leasehold on the airside of Building #14. Delta does not operate all cargo aircraft and uses this aircraft parking capability for maintenance and remain overnight aircraft.



Figure 5-1  
**Air Cargo Facilities**  
 Seattle-Tacoma International Airport



Source: May 29th meeting with Port staff

Table 5-1  
**Summary of Air Cargo Warehouse Tenants and Area**  
 Seattle-Tacoma International Airport

Tenant (Building #)	Warehouse (sq. ft.)	Airfreight (sq. ft.)	Integrator (sq. ft.)	Airmail (sq. ft.)	Total (sq. ft.)
Airline, Single Tenant					
FedEx (#6)	73,250		73,250		73,250
Southwest (#10)	25,700	11,000			11,000
Alaska Airlines (#11)	68,730	68,730			68,730
Delta Air Lines (#14)	58,000	58,000			58,000
Cargo Handling Company					
Hanjin (#2)	84,000	23,600			23,600
CAS (#8)	48,520	48,520			48,520
Swissport (#13)	31,560	31,560			31,560
WFS – Transiplex E (#3)	25,000	25,000			25,000
Other					
Matheson (#5 )	25,000			25,000	25,000
FedEx and USPS (#1)	51,720		15,000	36,720	51,720
Building #12	<u>49,260</u>				
Total	549,740	<u>266,410</u>	<u>88,250</u>	<u>61,720</u>	<u>416,380</u>

Sources: Port of Seattle, Webber Air Cargo, and Logplan LLC.

# General Aviation

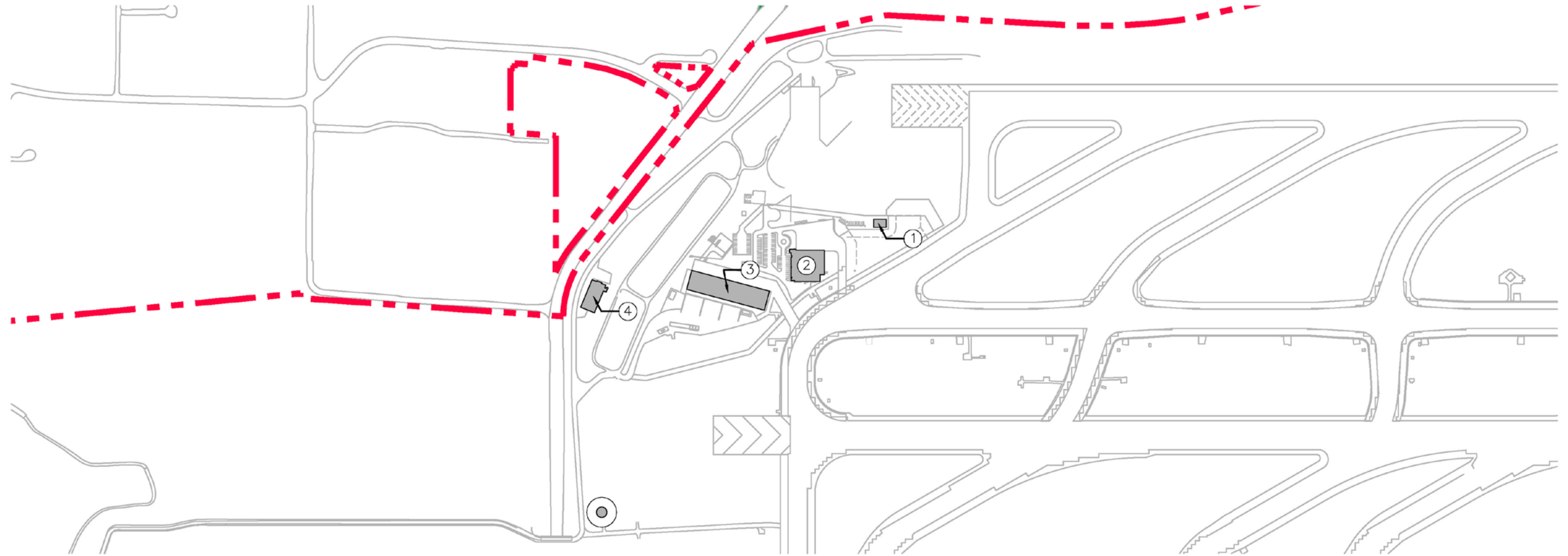
## 6.1 Introduction

General aviation (GA) activities at the Airport are considered light due to the availability of nearby local airports such as King County International Airport, Renton Municipal Airport, Snohomish County Airport (Paine Field), and several others. Weyerhaeuser Corporation maintains a 32,500 s.f. operations center and maintenance hangar for their jointly owned aircraft and is not considered a fixed base operator (FBO) as they do not service and maintain other aircraft. The Weyerhaeuser facility was constructed in 2000 and includes 56 parking spaces for employees, passengers and visitors. Access to the facility is through a secure gate. There are two 20,000 gallon underground Jet-a fuel storage tanks beneath the west side apron, filled from a truck rack outside the fence line. Figure 6-1 illustrates the GA area and other non-GA related buildings.

Aircraft Services International Group (ASIG) maintains an apron and FBO operations office facility located adjacent and north of the Weyerhaeuser hangar. ASIG also provides fueling, Ground Service Equipment (GSE) maintenance, and de-icing services to the commercial airlines under a variety of contract arrangements. ASIG data indicates that all of the GA operations were assisted via the FBO in 2013 from their 3,750 s.f. modular GA center. The center is accessed via S. 188<sup>th</sup> St. and parking is provided for 12 customer and/or employee vehicles. The aircraft apron area adjacent and east of the building is approximately 48,000 s.f. in area and can accommodate up to nine aircraft. The apron is under the Port's ownership.



Table 6-1 summarizes information relative to the general aviation services and facilities on the southwest side of the Airport.

Figure 6-1  
**General Aviation Area**  
 Seattle-Tacoma International Airport



LEGEND

- 1. General aviation building
- 2. Weyerhaeuser corporate hangar
- 3. Snow equipment storage
- 4. Industrial waste treatment plant

-  Airport buildings
-  Airport property line



Source: Port

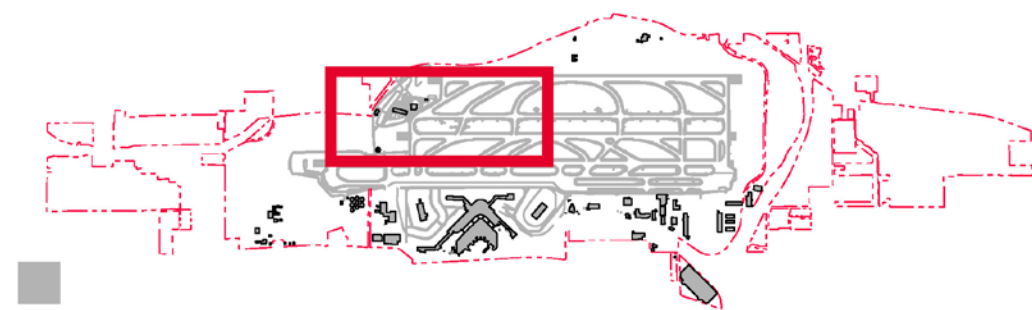


Table 6-1  
**General Aviation Summary**  
 Seattle-Tacoma International Airport

Tenant	Property status	Property size	Employee/ customer parking	Ramp area (s.f.)	Based aircraft type & (no.)	Parking positions	2013 operations	Based aircraft ownership	Gross bldg. area (s.f.)	Office area (s.f.)	Hangar area (s.f.)	Service & maintenance area (s.f.)	Pilot/ Passenger area (s.f.)
Weyerhaeuser Corporate Hangar	Land lease	144,215 s.f.	56	31,350	Cessna Citation Excel (1)	1	8	Joint	35,230	2,300	19,570	11,530	1,830
					Diamond DA 50 (2)	2	95						
ASIG FBO	Land lease	3,750 s.f.	12	48,000	n.a.	9	868	None	3,750	1,250	n.a.	on apron	2,500
ASIG GSE	Land lease	25,819 s.f. North Site											

Notes:

ASIG = Aircraft Service International Group

FBO = Fixed-based Operator

GSE = Ground Service Equipment (GSE)

Weyerhaeuser Hangar:

Corporate Hangar Building owned by Weyerhaeuser.

Fleet is partnership with PACCAR.

Operations are currently 10% Weyerhaeuser.

Staff of six are Weyerhaeuser employees.

Ramp area is deemed inadequate.

ASIG:

Typical FBO services, including fueling; pilot lounge, flight planning, and hospitality services.

GSE Maintenance located south of Cargo 7 ramp area.

ASIG eastside cargo area offices, incl. Commercial fueling and deicing dispatch.

Source: Port of Seattle, 2014.

# Airline and Airport Support

## 7.1 Airline Support

In addition to FBO services, Aircraft Service International Group (ASIG) provides fueling, de-icing and ground handling equipment maintenance for a majority of the commercial and cargo airlines. ASIG currently has 3300 s.f. of office space in the former United Airlines (UAL) Cargo building. Approximately 100 employees work for the company. The ASIG equipment fleet includes the following: 28 stationary fuel sites, 15 fuel tanker trucks, nine hydrant fueling vehicles, eight general service vans and pick-up trucks, and two de-icing trucks. These vehicles are stored at various locations but predominantly at the 25,819 s.f. ASIG-leased property located south of the Alaska Airlines hangar. There is a 4,000-gallon above ground storage tank (AST) for glycol at the maintenance facility.

Swissport also provides a variety of airline support services with their 100 plus employees at the Airport. In addition to the fueling operation described in a later section, Swissport provides aircraft loading/unloading, baggage sorting, de-icing, ground power unit (GPU) service, push-back, aircraft servicing and cleaning, aircraft security, and GSE repair services. These services are provided from leased facilities. Figures 7-1 and 7-2 illustrate the airline and airport support areas.

### 7.1.1 Airline Hangars

There are significant support facilities established for and/or by the airlines at the Airport. As a local based corporation, Alaska Airlines considers the Airport its operating hub. As a result there are several corporate facilities within the City of SeaTac and elsewhere. On-airport facilities include two Alaska Maintenance Hangar located south of the main terminal and south satellite. Office space is also provided at this site to support airline operations.

Delta owns and operates a maintenance hangar located to the south of Concourse A and adjacent to the Delta Cargo building.

United Airlines retains a maintenance facility located in the Air Cargo 4 area.

### 7.1.2 Flight Kitchens

There are currently three providers of aircraft food and beverage services operating at the Airport. Gate Gourmet, Flying Foods and SkyChef are tenants in different locations with Gate Gourmet the largest, with 250 employees, loading between 110 and 120 trucks per day, and operating out of a 60,000 s.f. facility.

Table 7-1 presents data for the flight kitchens. The locations of flight kitchens are shown in Figure 7-1.

### 7.1.3 Ground Service Equipment

As described earlier, GSE storage and repair is provided in part by Swissport and ASIG. In addition, the Port, Alaska Airlines, Delta Air Lines, and United Airlines maintain equipment and storage areas for GSE.

### 7.1.4 Aircraft Fuel Storage and Distribution

The Airport's airline jet fuel supply is stored on an approximate 10.5 acre facility located on the south side of S. 188<sup>th</sup> St.. The facility includes a main office, laboratory and maintenance facility, eight above ground storage tanks, pumps, and pipes. An underground hydrant system connects the storage tanks with fuel pits located at the Airport's aircraft parking positions with the exception of those located in the north cargo area. Aircraft parked in the north cargo area are refueled using tankers. These tankers are refilled at a load rack located near Cargo 5. Since 2004, Swissport has managed and operated the airline fuel storage and distribution system for an airline fuel consortium.

The capacity of the tank farm is approximately 412,660 barrels (17.33 million gallons). In 2013, over 420 million gallons were consumed with an average day volume of 1.2 million gallons. On a single day in June 2014, the Airport experienced a peak demand volume of 1.7 million gallons.

In addition, the fixed base operator stores both JetA and AVGAS (aviation gasoline). Table 7-2 summarizes the Airport's airline and fixed base operator fuel storage capacity.

Fuel is supplied to the tank farm via an Olympic fuel pipeline flowing from Anacortes in the north to Eugene, Oregon through Renton. A 12-inch diameter spur line serves the Airport. The line is capable of supplying 5,250 gallons per minute in delivery batches between 4,500 and 7,200 barrels (180,600 – 6.72 million gallons per day). Swissport manages fuel demand and supply and the metrics for demand are established by projected consumption on a monthly basis. Swissport typically manages the system to assure an approximate inventory of seven to nine days is always available. Since the pipeline carries other fuels, the supply to the Airport is not continuous, nor is it guaranteed, as demonstrated in 1999 when the Olympic pipeline flow was interrupted due to rupture near Bellingham. In the event of a shutdown, the rate of consumption far exceeds the ability to secure and load imported fuel via a truck rack. The Airport is believed to be the only U.S. airport without a back-up supply system.

Table 7-3 illustrates the fuel source data information referenced above.

The tank farm serves the total passenger gate needs through its hydrant fuel system consisting of 167 hydrant pits. Table 7-4 provides additional information of the nature of the system. Table 7-4 summarizes the inventory of vehicles used to provide fuel into plane. Figure 7-3 illustrates the fuel hydrant system for the Airport.

When necessary to rely on truck racks for air cargo or vehicles for remote passenger aircraft Swissport utilizes its fleet of fueling and service vehicles. Such fleet is described in Table 7-5.

Total fuel consumption for calendar year 2013 was 451 million gallons of Jet-A fuel through Swissport. Weyerhaeuser trucked in and consumed 148,000 gallons of Jet-A fuel, which was purchased on the open market.

## **7.2 Airport Support**

### **7.2.1 Aircraft Rescue and Firefighting**

The Port Fire Department serves the Airport on-site. There are local and regional agreements for emergency response with other municipalities for support in a mutual aid situation. The Aircraft Rescue and Fire Fighting (ARFF) headquarter and base is currently located on airfield at the terminus of S. 170<sup>th</sup> St. The ARFF occupies approximately 28,800 s.f. and includes a vehicle bay for response vehicles, communications, offices, training and lodging facilities for the firemen. Table 7-6 and Table 7-7 describe the ARFF facility and the available vehicle equipment.

Airfield rescue and firefighting training is provided on-site at the ARFF, and also remotely on the west side of the airfield, and occasionally in the air cargo north area where a mock-up aircraft is stored.

### **7.2.2 Ground Run-up Enclosure**

The Port has recently performed a siting study and facility description for a planned aircraft ground run-up enclosure. The facility will include a three-sided barrier enclosure and will be sized to accommodate a Boeing 737-900W aircraft. A decision has yet to be made on this facility as two of the sites impact available hardstand use and the third requires significant improvement. Table 7-8 outlines the site options identified.

### **7.2.3 Airport Maintenance**

The Port Aviation Maintenance Department is responsible for the operation and upkeep of all assets of the Aviation Division. These services and staff are assigned to work out of a multitude of locations both within and outside the terminal area.

Table 7-9 illustrates the main locations and facilities for the wide variety of maintenance functions and services. Department Management, Logistics and Business Services are provided from the Airport Office Tower. In general, fleet maintenance and operation is conducted at the Bus Maintenance Facility and the Port Cargo 4 building. Air Cargo 4 is also the base for airfield technicians and laborers, carpenters, painters, buildings and grounds, In addition de-icing glycol is stored in three AST totaling 55,000 gallons in capacity.

The Port constructed a Central Distribution Center within the last 10 years, which is located off Des Moines Memorial Drive, south of S. 188<sup>th</sup> St.. This facility is the center of procurement, supplies, and distribution.

Maintenance of the STS is provided via two STS level maintenance areas located beneath the main terminal. Transfer tables are provided between the NSAT and SSAT loops and the main terminal shuttle line. A maintenance area is provided at each transfer table.

Electrical and electronics maintenance is provided at multiple locations. Maintenance shops, located in the vicinity of the main terminal central loading dock and the Cargo 4 building, house the radio and electrical technicians. The majority of the electrical work is performed at and from shops located on the baggage claim level of Concourse A. Mechanical systems, specifically the conveyance systems, are

provided from shops located under the central terminal area, on the bag claim level. Passenger loading bridges are maintained from shops beneath Concourse A.

The Central Plant houses the operating engineers for mechanical and utilities, with the exception of the industrial waste treatment operating engineers who are at the industrial waste system (IWS) plant.

Snow removal and other maintenance storage are provided just south of the Weyerhaeuser hangar. This facility is 41,500 s.f., and equipment and materials are exposed to weather conditions. De-icing chemicals are stored in pallet sacks, which must be cut open, and hand transferred from elevated forklifts. This 5.3-acre area is also the location for storage of contaminated soils and hazardous waste prior to their off-site disposal or explosive detonation by the Port police and the TSA.

Table 7-10 summarizes the snow removal equipment at the Airport.

### **7.2.4 Airport Utilities Infrastructure**

The 2,300 acre Airport site features the following utility infrastructure systems: electrical, industrial waste, mechanical, stormwater, sanitary sewer, vertical conveyance, and water. The descriptions below and Table 7-11 summarize the core infrastructure elements.

#### **7.2.4.1 Electrical System**

The Airport consumed 144,670-megawatt hours in calendar year 2013, which includes sub-metered electricity sold to Airport tenants. While the Airport has negotiated a low-cost rate from the Bonneville Power Authority, the infrastructure required to support the power system is significant. Two major service points serve the Airport. The north main substation is a 25MW plant and the south main substation is a 25MW plant. The Airport has established 14 emergency diesel generators.

There are three main distribution centers supplying power to 22 major facility power centers, with over 1,500 service panels.

Figure 7-4 illustrates the major electricity lines within the Airport property as well as the two major service points and three main distribution centers.

#### **7.2.4.2 Industrial Waste System**

Collection points for the industrial waste system (IWS) are found within the passenger terminal building, main garage, and all ramp areas. The IWS system delivers waste, notably de-icing glycol from the ramp areas, to the industrial waste treatment plant located near the general aviation facility at the south western corner of the airfield, north of S. 188<sup>th</sup> St.. Figure 7-5 illustrates the IWS lines.

#### **7.2.4.3 Mechanical Systems**

The core of the mechanical infrastructure lies in the Central Plan housed on Floors 1 and 2 of the parking garage. The central plant consumed 3.0 million therms of natural gas in 2013 sourced from Puget Sound Energy. The gas heated four boilers, which were capable of generating 130,000 lbs./hour of steam. The steam fuels eight chillers with a capacity of 14,400 tons. Five cooling towers and three heat exchangers enable the central plant to condition the air of a 3.1 million s.f. area.

Starting in 2013, the Airport has provided pre-conditioned air (PCA) to gated aircraft through the use of four 1,200 ton capacity chillers, a pumped condenser water return system, and eight chilled glycol pumps. There are currently 64 PCA units in operation out of a total 68-gate design. There are plans to offer PCA at all gates in the future.

#### **7.2.4.4 Sanitary Sewer**

Figure 7-6 illustrates the sanitary sewer lines within the Airport property.

#### **7.2.4.5 Storm Water Drainage**

Figure 7-7 illustrates the storm water drainage lines within the Airport property.

#### **7.2.4.6 Vertical Conveyance**

Within the multi-level terminal areas and garage at the Airport, there are 81 elevators and an equal number of escalators. In addition, there are six moving walkways in Concourse A. These systems have been upgraded recently as part of an airport-wide improvement project and will be further evaluated under the NSTAR program.

#### **7.2.4.7 Water System**

Over 281 million cubic (210 million gallons) of potable water were consumed in calendar year 2013, using two major pumps housed at the pumphouse in the north Air Cargo 3 area. These pumps are supplied by a two million gallon steel tank reservoir. In addition, there are twelve water pumps for emergency demand. Figure 7-8 illustrates the potable water lines within the Airport property.

#### **7.2.4.8 Natural Gas System**

Over 2.5 million therms of natural gas were consumed in calendar year 2013. Figure 7-9 illustrates the natural gas lines within the Airport property.

#### **7.2.4.9 Storm Water Drainage Basins**

Storm water drainage basins are depicted on Figure 7-10.

#### **7.2.4.10 Waste and Recycling Facilities**

To increase efficiencies and leverage economies of scale, the Port utilizes a centralized waste collection system. Contracted janitorial crews, and in some cases tenants, take the municipal solid waste (MSW) to central collection sites using tilt trucks or service carts. Each collection site has one compactor for commingled recyclables and one compactor for garbage. Multiple service providers haul garbage, recyclables, compostables, and other wastes from compactors, drop boxes, and dumpsters in the Port's central waste collection sites.

In 2013, the Port generated 7,888 tons of waste materials. The Airfield diverted 218 tons, or 10%, of the 2,136 tons of waste materials generated. The Terminal diverted 1,793 tons, or 31%, of the 5,752 tons of waste materials generated.

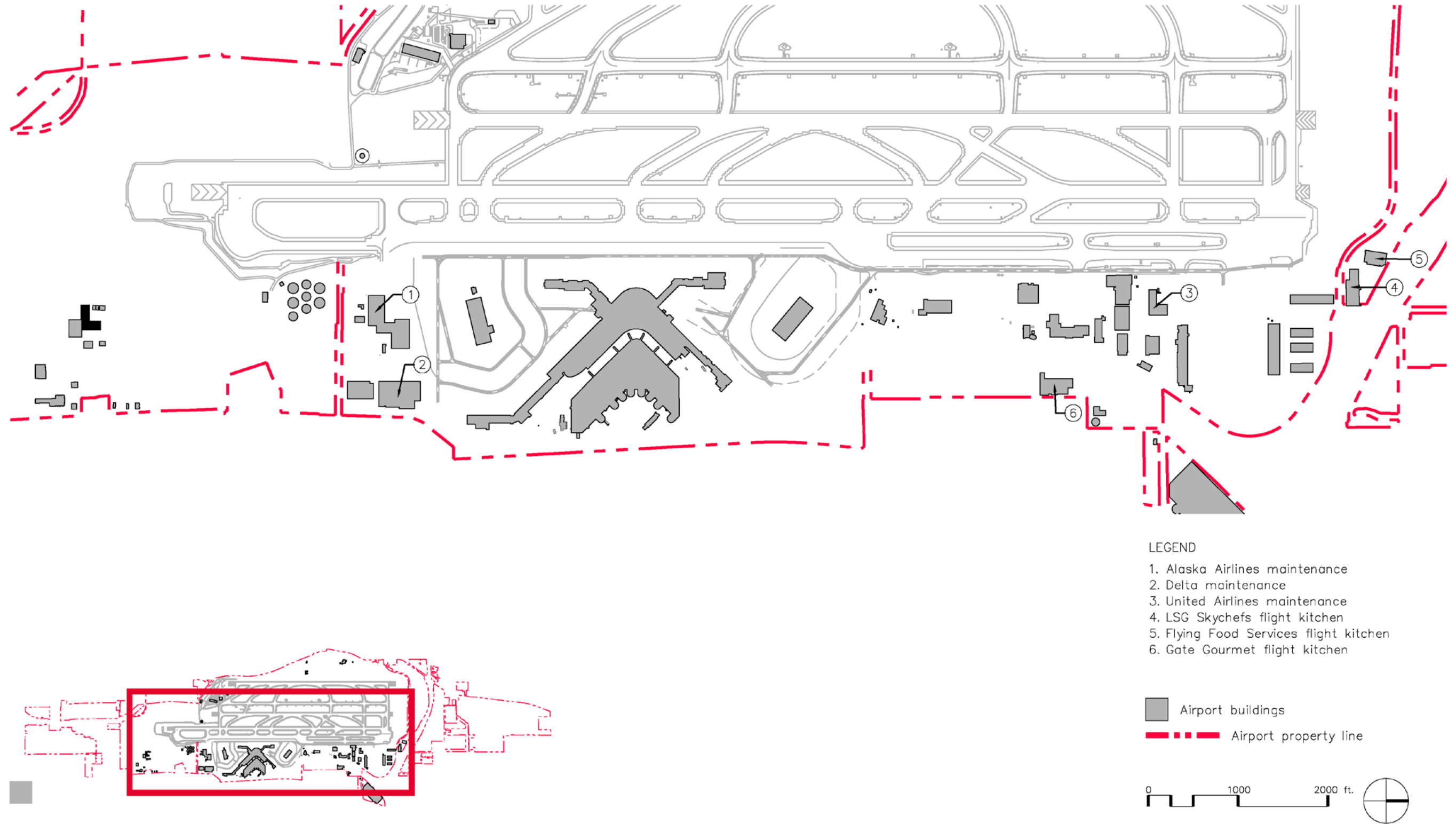
To minimize construction and demolition (C&D) debris, the Port developed a Port Construction Waste Management Specification to help implement Best Management Practices (BPM) that reduce construction, demolition, and land clearing debris that the Port and its contractors generate. The diversion rate for C&D debris by Port contractors is 98%.

The FAA Modernization and Reform Act of 2012 (FMRA) requires that any new or updated master plan address issues relating to solid waste recycling by including: (1) the feasibility of solid waste recycling at the airport; (2) minimizing the generation of solid waste at the airport; (3) operation and maintenance requirements; (4) review of waste management contracts; and (5) the potential cost savings or the generation of revenue.

The sustainability master plan will meet the requirements of the FMRA.



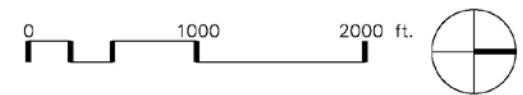
Figure 7-1  
**Airline Support Areas**  
 Seattle-Tacoma International Airport



LEGEND

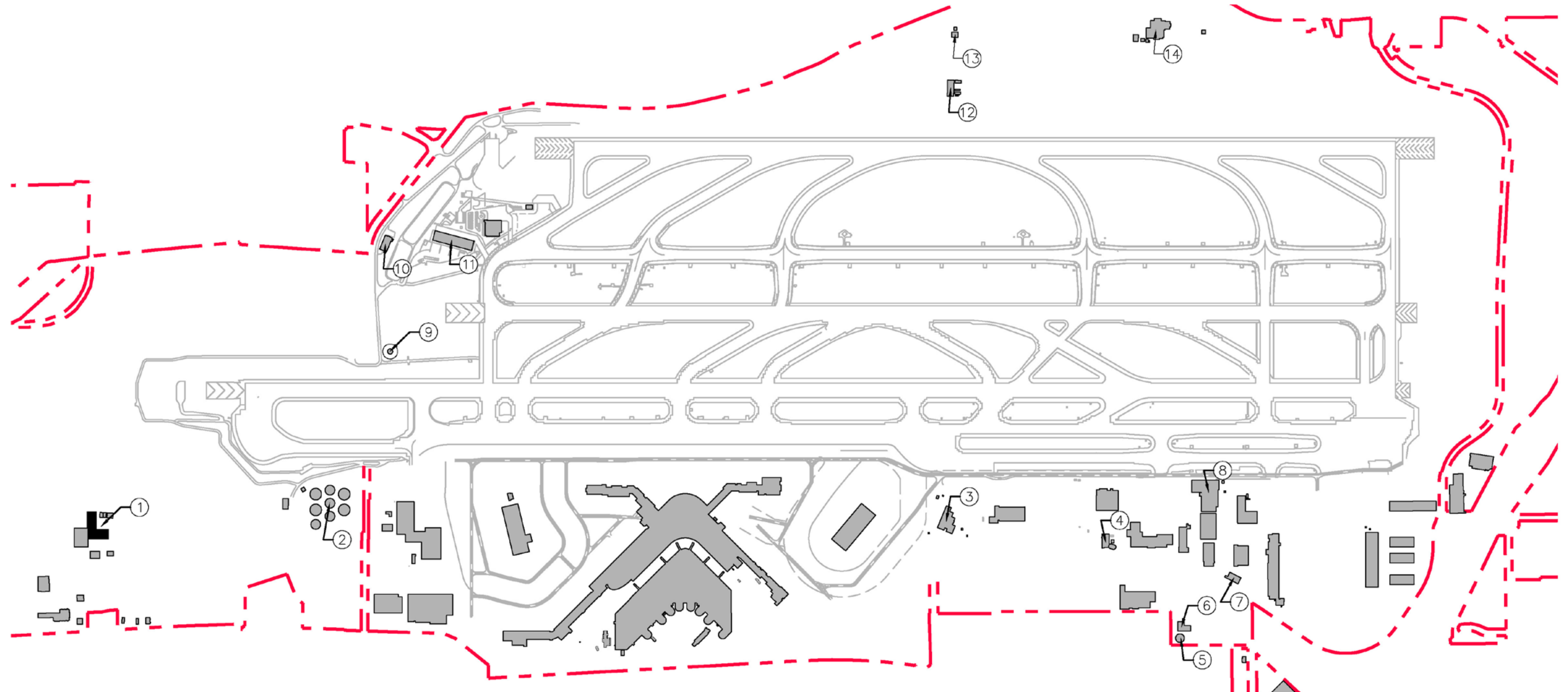
- 1. Alaska Airlines maintenance
- 2. Delta maintenance
- 3. United Airlines maintenance
- 4. LSG Skychefs flight kitchen
- 5. Flying Food Services flight kitchen
- 6. Gate Gourmet flight kitchen

- Airport buildings
- - - - Airport property line



Source: STIA ALP (2007)

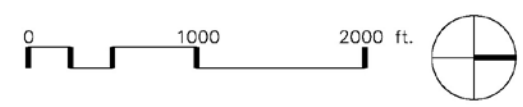
Figure 7-2  
**Airport Support Areas**  
 Seattle-Tacoma International Airport



LEGEND

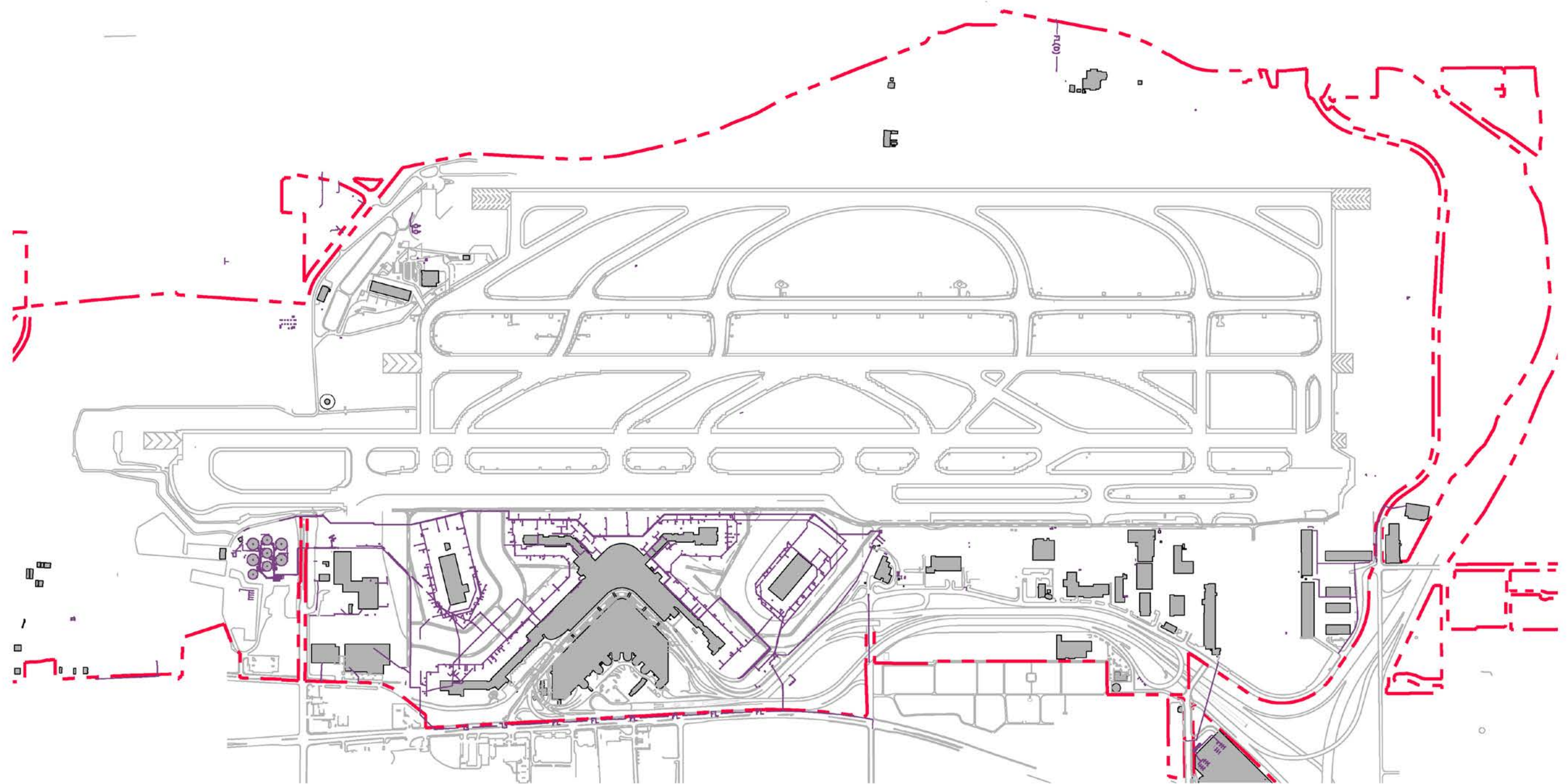
- |  |                                      |
|--|--------------------------------------|
| 1. Port laydown/storage/emp. parking complex | 8. Port airport maintenance          |
| 2. Fuel storage area                         | 9. VORTAC                            |
| 3. Aircraft rescue & fire fighting station   | 10. Industrial waste treatment plant |
| 4. Airport traffic control tower (ATCT)      | 11. Snow equipment storage           |
| 5. Water tower                               | 12. TRACON                           |
| 6. Port offices                              | 13. Port westside offices            |
| 7. Pump house                                | 14. ASR-9 antenna                    |

- Airport buildings
- Airport property line



Source: STIA ALP (2007)

Figure 7-3  
Major Airport Utilities – Jet Fuel  
Seattle-Tacoma International Airport

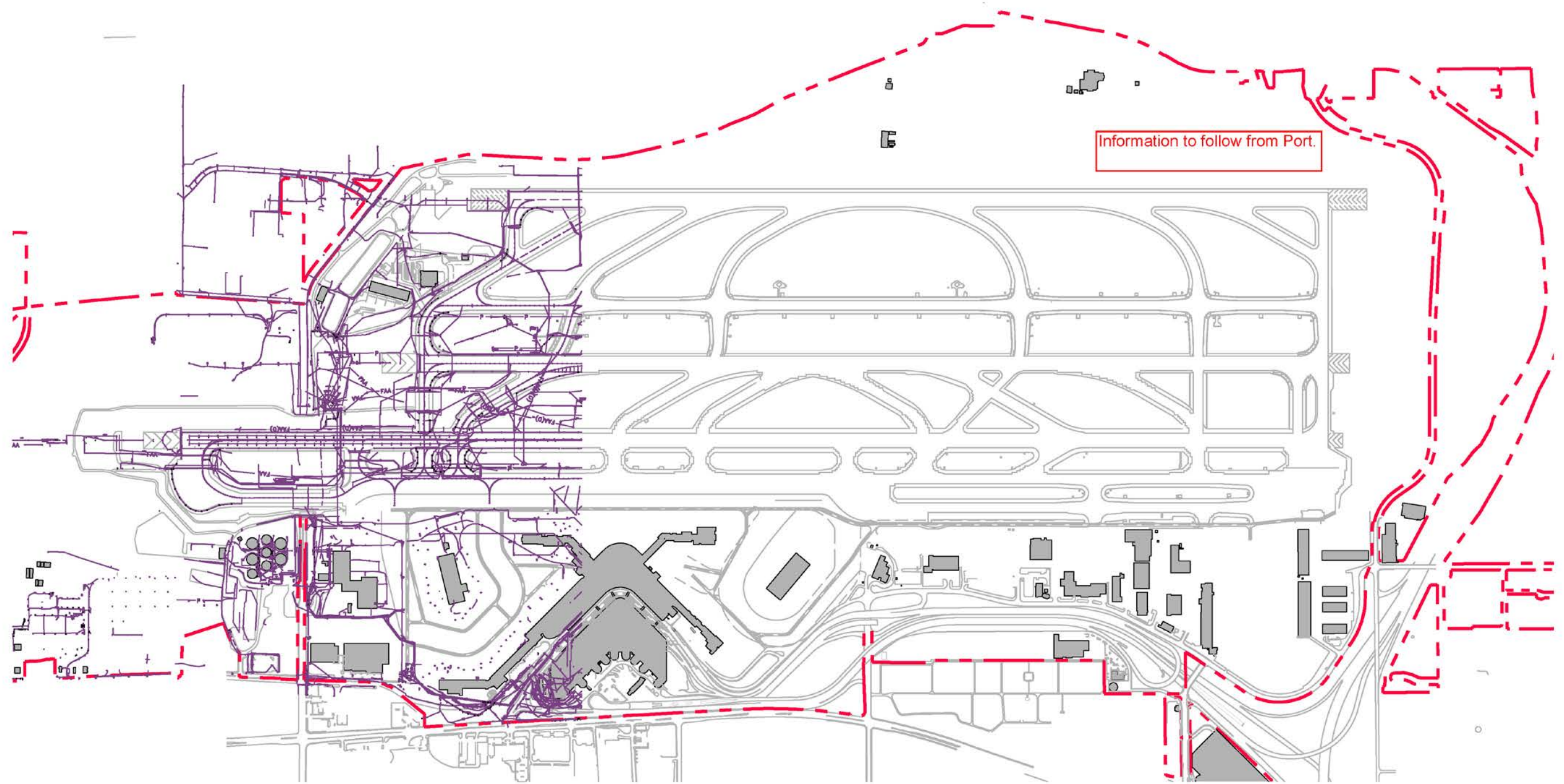


- LEGEND**
- Airport buildings
  - — — Airport property line
  - FL — Jet fuel



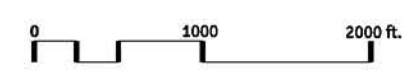
Source: Port AutoCAD file, "2 FUEL mrd-ful.dwg"

Figure 7-4  
Major Airport Utilities – Electrical  
Seattle-Tacoma International Airport



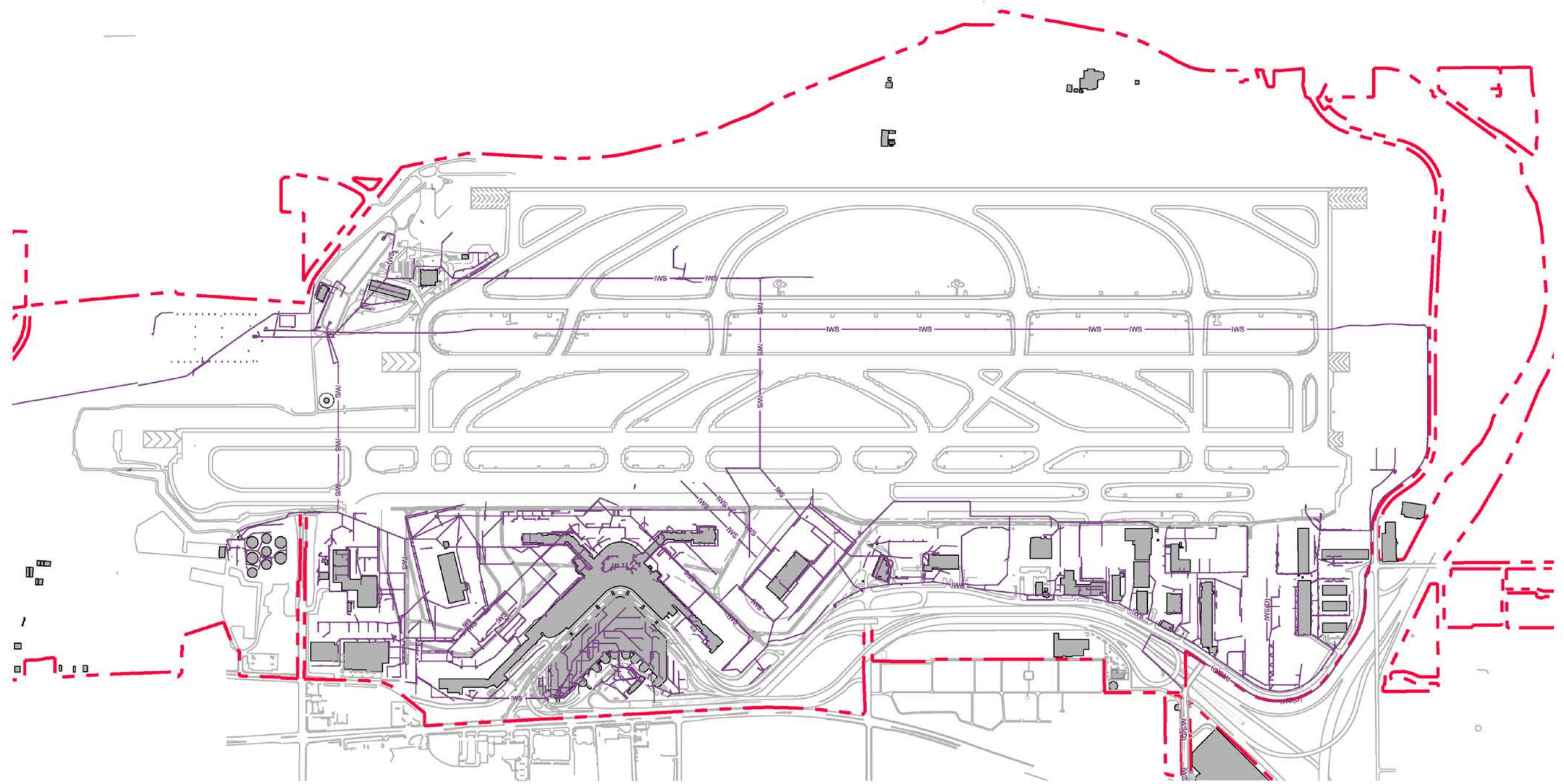
**LEGEND**

-  Airport buildings
-  Airport property line
-  Electrical



Source: Port AutoCAD file, "4 ELECTRICAL mrd-pt 01-095.dwg"

Figure 7-5  
**Major Airport Utilities – Industrial Waste System**  
 Seattle-Tacoma International Airport



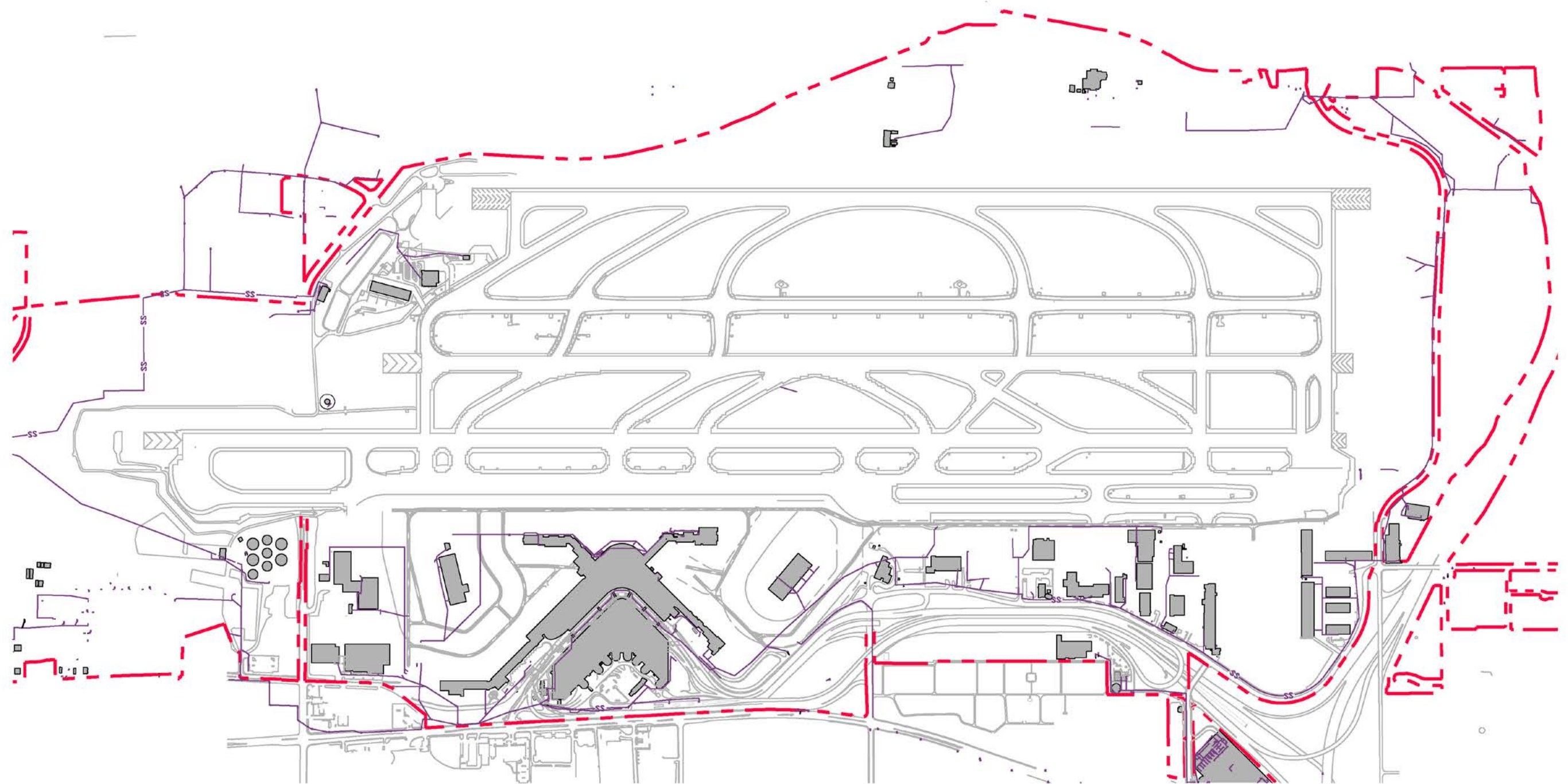
**LEGEND**

- Airport buildings
- Airport property line
- IWS Industrial waste system



Source: Port AutoCAD file, "6 STORM mrd-st\_CIVIL 3D\_IWS.dwg"

Figure 7-6  
Major Airport Utilities – Sanitary Sewer  
Seattle-Tacoma International Airport



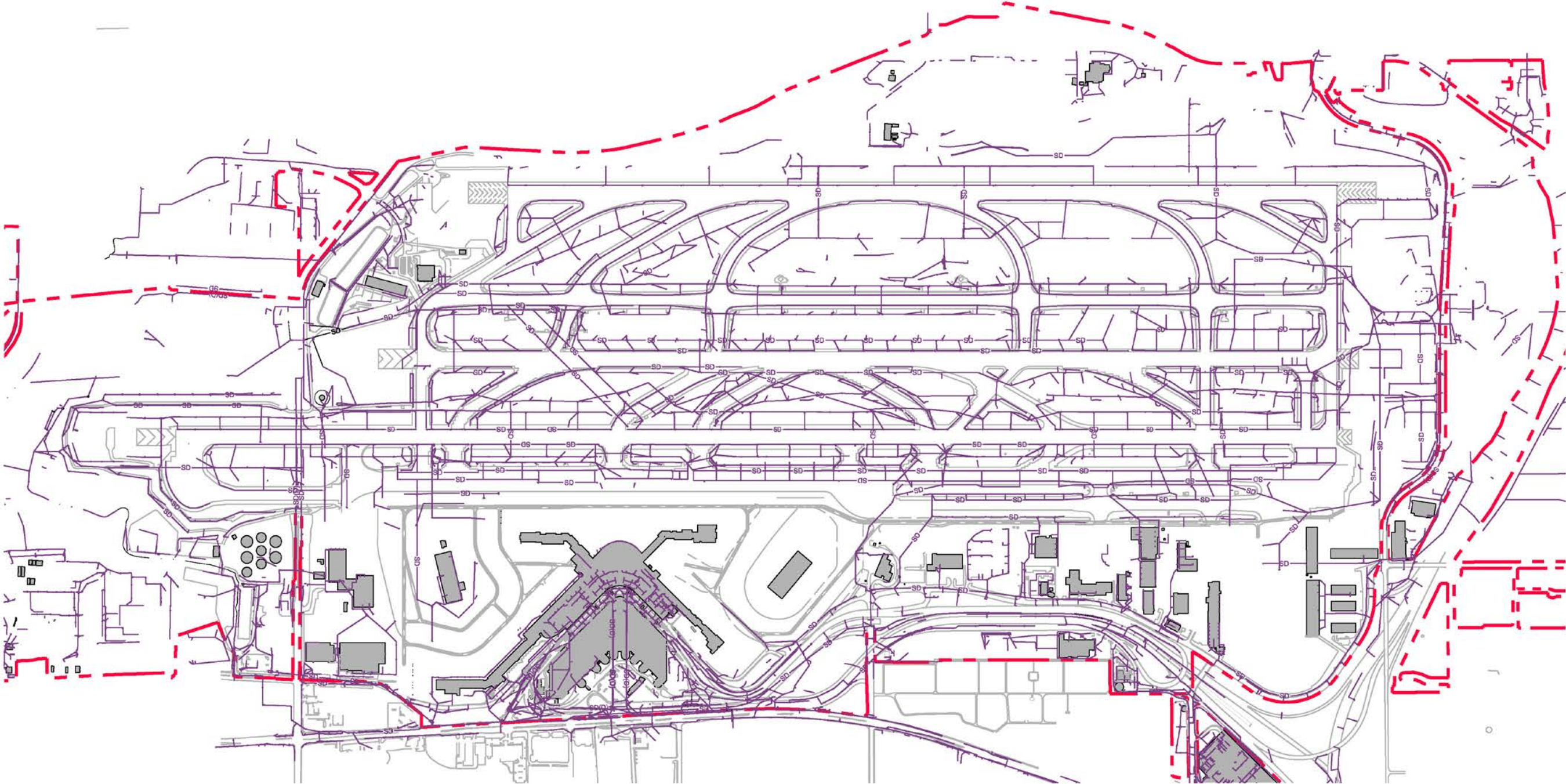
**LEGEND**

-  Airport buildings
-  Airport property line
-  SS Sanitary sewer



Source: Port AutoCAD file, "5 SANITARY mrd-ss.dwg"

Figure 7-7  
Major Airport Utilities – Stormwater Drainage  
Seattle-Tacoma International Airport



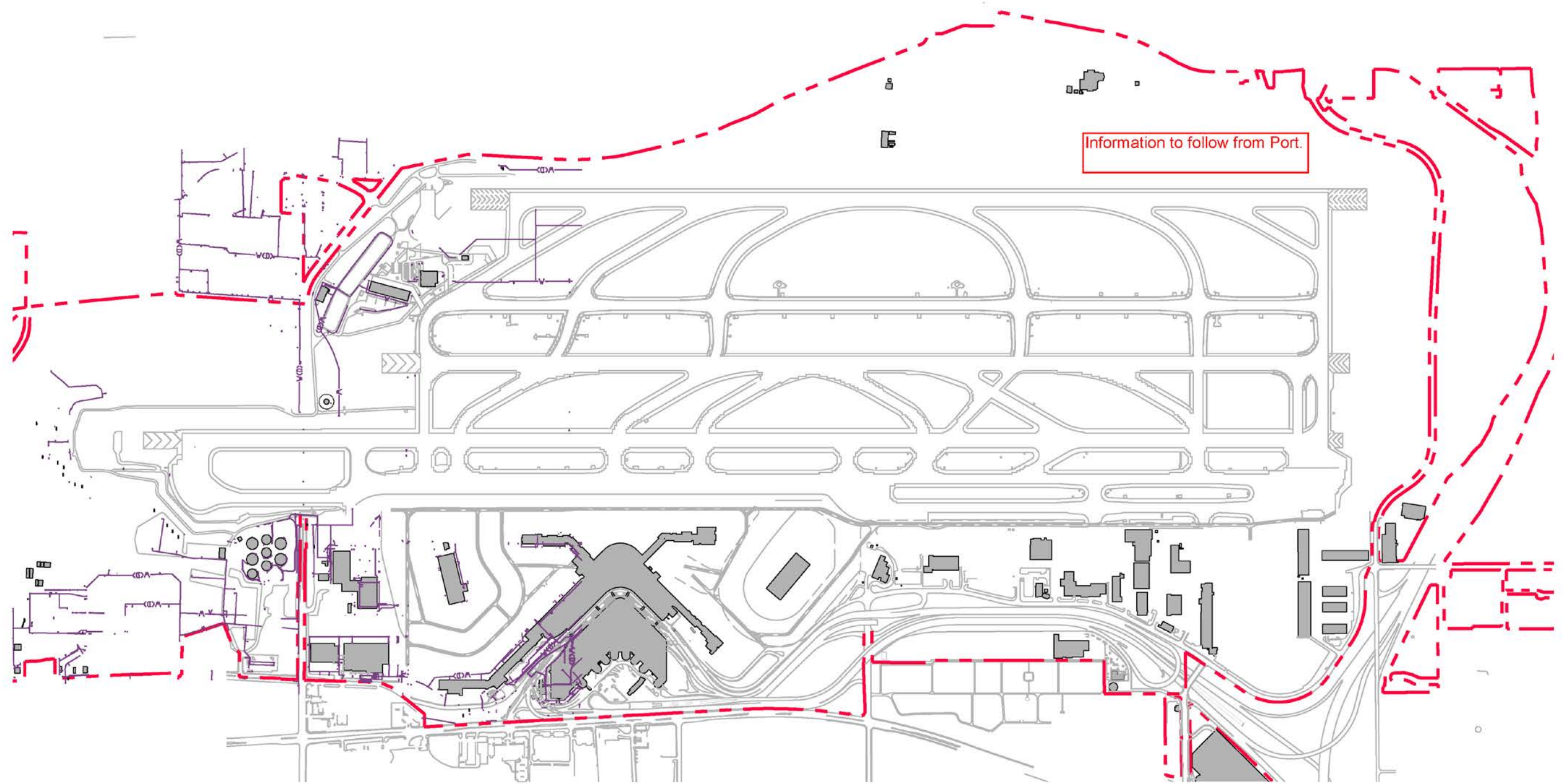
**LEGEND**

- Airport buildings
- Airport property line
- SD— Stormwater drainage



Source: Port AutoCAD file, "6 STORM mrd-st\_CIVIL 3D\_SD.dwg"

Figure 7-8  
Major Airport Utilities – Water  
Seattle-Tacoma International Airport



**LEGEND**

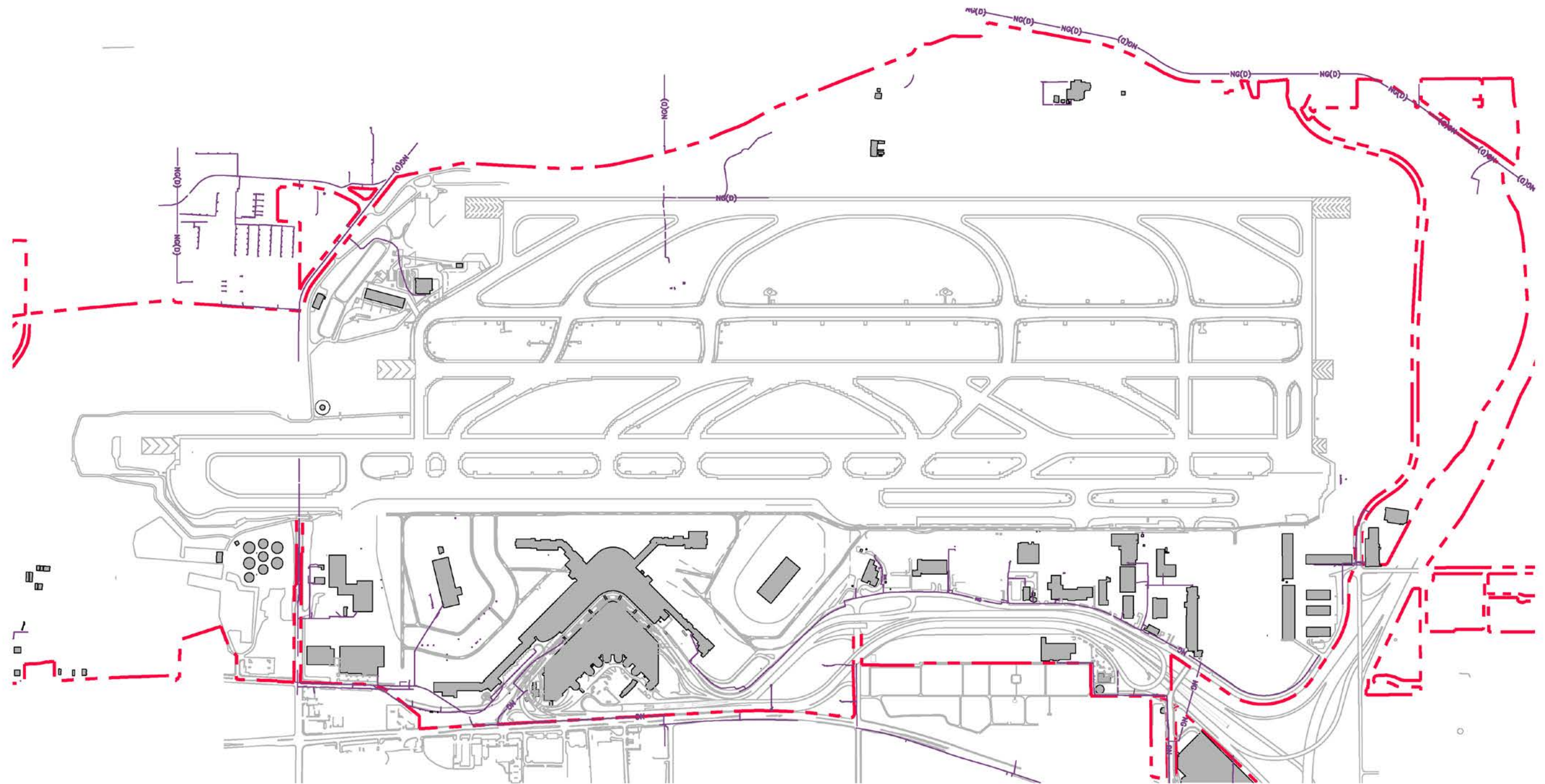
-  Airport buildings
-  Airport property line
-  Water



Source: Port AutoCAD file, "7 WATER mrd-wtr 01-09s.dwg"



Figure 7-9  
Major Airport Utilities – Natural Gas  
Seattle-Tacoma International Airport

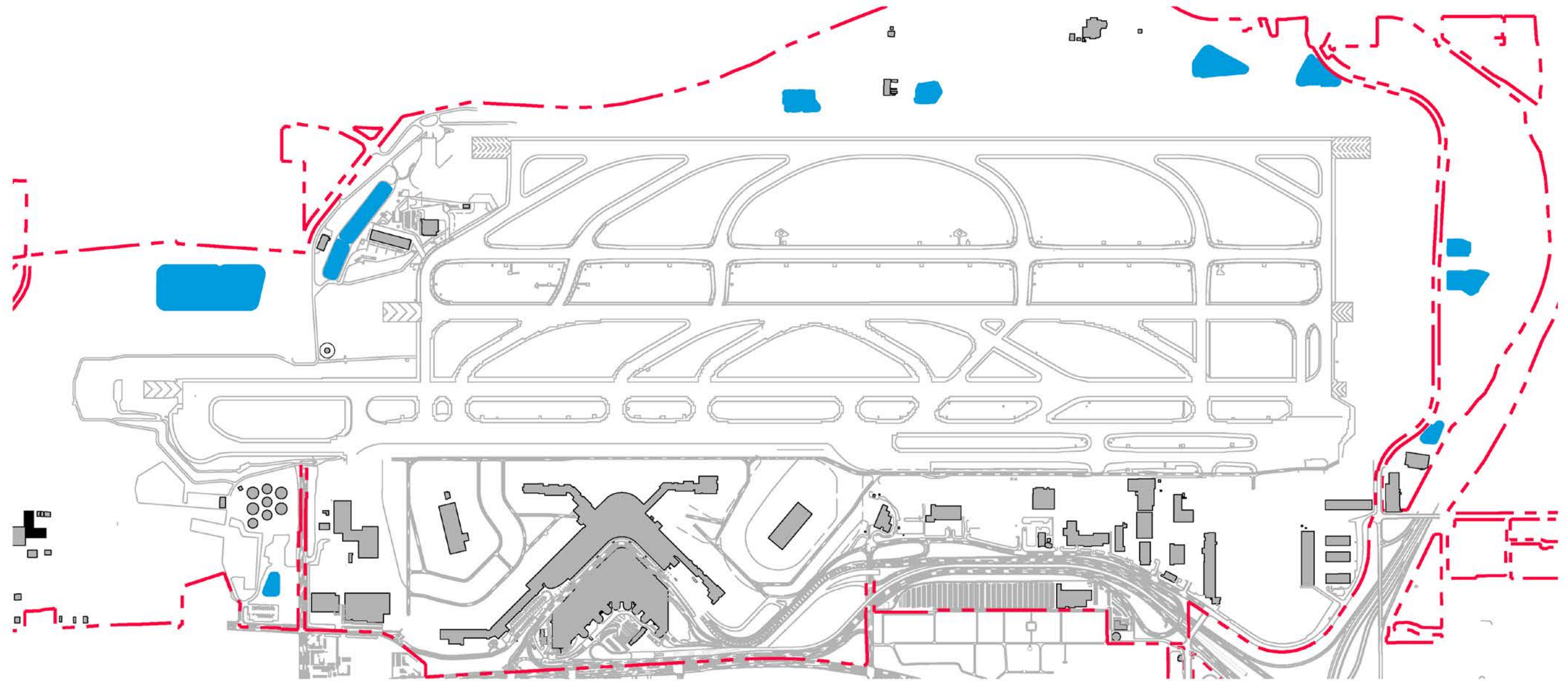


- LEGEND**
- Airport buildings
  - Airport property line
  - NG Natural gas



Source: Port AutoCAD file, "2 FUEL mrd-ful.dwg"

Figure 7-10  
Storm Water Drainage Basins  
Seattle-Tacoma International Airport



LEGEND  
■ Storm water drainage basins  
■ Airport buildings  
- - - Airport property line



Source: Google Earth

Table 7-1  
**Flight Kitchen Summary**  
 Seattle-Tacoma International Airport

Facility/location	Gross lease area (s.f.)	Building area (s.f.)					No. of employees	Parking spaces	Meal capacity	Avg. daily output	Vehicle trips per day (Airfield) (2-way trips)
		Office	Production	Shipping/receiving/storage	Other	Total					
Gate Gourmet	152,000	5,000	15,000	15,000	25,000	60,000	250	116	20,000 max.	12,000	110
Flying Foods	90,114	1,268	12,237	15,532	1,012	30,049	120	49	8,000 max.	5,000	20
SkyChef	<u>52,000</u>	<u>6,000</u>	<u>12,640</u>	<u>23,600</u>	<u>9,760</u>	<u>52,000</u>	<u>420</u>	<u>111</u>	<u>12,000 max</u>	<u>10,000</u>	<u>145</u>
<b>Total</b>	294,114	12,268	39,877	54,132	35,772	142,049	790	276	40,000	27,000	275

Source: Port of Seattle, 2014.

Table 7-2  
**Fuel Storage Capacity Summary**  
 Seattle-Tacoma International Airport

Location /site	ID number	Type	Capacity (barrels)	Product	Notes
S. 188th Tank Farm	108	AST	58,431	JET A	Includes a single truck rack.
	109	AST	58,429	JET A	
	110	AST	38,507	JET A	
	111	AST	39,176	JET A	
	112	AST	38,510	JET A	
	113	AST	38,569	JET A	
	114	AST	70,532	JET A	
	115	AST	<u>70,505</u>	JET A	
	<b>Total</b>			412,659	
<b>Fixed Base Operators</b>					
Weyerhaeuser	1	UST	10,000	AVGAS	
ASIG	1	Tanker	<u>700</u>	AVGAS	
<b>Total</b>			10,700		

Notes:  
 1 US barrel (Bbl.) = 42 US gallons liquid.  
 AST = Above ground storage tank  
 UST = Underground storage tank

Source: Port of Seattle, 2014.

Table 7-3  
**Fuel Storage Supply System**  
 Seattle-Tacoma International Airport

Location/site	Source	Source type	Frequency	Source capacity
S. 188th Tank Farm	Olympic	Pipeline Truck Rack	On demand scheduled Emergency	5,000 – 6,000 GPM 1 – 4,000 gal/truck
Fixed Base Operators Weyerhaeuser ASIG	Offsite	Truck	As required As required	n.a.

Notes:

GPM = Gallons per minute

Source: Port of Seattle, 2014.

Table 7-4  
**Fueling Delivery Summary – Jet-A Fuel**  
 Seattle-Tacoma International Airport

System	Served gates	Supply type & no.	Supply size	Flow capacity	Consumption
Hydrants	N, S, A, B, C, D	167	20-inch x 2	6,000 GPM	+1mil. gal. per day
Truck load rack	Air cargo	1			
Weyerhaeuser	Apron	1	Pump hose		148,000 gal. (2013)

Notes:

GPM = Gallons per minute

Source: Port of Seattle, 2014.

Table 7-5  
**Fueling Vehicle Inventory**  
 Seattle-Tacoma International Airport

Vehicle	Number	Capacity (gallons)	Base location
Swissport			
15k tanker	3	15,000	Ramp
10k tanker	10	10,000	Ramp
5k tankers	6	5,000	Ramp
ASIG			
15k tanker	4	15,000	Ramp
10k tanker	8	10,000	Ramp
5k tankers	2	5,000	Ramp
Hydrant vehicle	9		

Source: Port of Seattle, 2014.

Table 7-6  
**ARFF Facility Summary**  
 Seattle-Tacoma International Airport

Facility/function	Floor area (s.f.)	
	Ground	2nd floor
Apparatus bay	10,843	--
External carport	2,858	--
Shop/storage (medical hazard)	1,199	1,683
Crew quarters	4,384	--
Dining	1,254	--
Training	1,260	1,681
Office/admin	5,735	--
Mechanical/electrical/communication	607	744
Hose building	660	--
Total	28,800	4,108

Source: Port of Seattle, 2014.

Table 7-7  
**ARFF Vehicle Summary**  
 Seattle-Tacoma International Airport

Vehicle ID	Vehicle make/model	Mfg. year	Function	Life cycle year	Notes
<b>Response Vehicles</b>					
S-777	Ford	1989	Haz-Mat/Confined Space Rescue/Response Unit		
779	Ford F350	1990	Salvage Truck, Water Removal and Equipment		
776		1982	Foam Tanker (1500 gal. AFFF, 160 GPM)		For mobile resupply
E- 712	Darley	1995	Pumper Engine (2000 GPM, 500 gal. water)	2012	Considered a reserve vehicle
T-763	Oshkosh CFR	1996	ARFF Crash Unit (1950 GPM, 3000 gal. water, 420 gal. AFFF)	2012	Considered a reserve vehicle
778	Freightliner	2000	Tractor for Mass Casualty Response Trailer	2016	
765	Oshkosh TI-3000	2000	ARFF Crash Truck (1950 GPM, 3,000 gal. water, 420 gal. AFFF)		
732	Freightliner	2000	Aid Car		Considered a reserve vehicle
T-764	Oshkosh Striker 3000	2006	ARFF Crash Truck (1950 GPM, 3,000 gal. water, 420 gal. AFFF)	2017	
T-762	Oshkosh Striker 3000	2010	ARFF Crash Truck (1950 GPM, 3,000 gal. water, 420 gal. AFFF)	2019	
E-711	E-One	2011	Pumper Engine (2000 GPM, 500 gal. water)		
731	International	2011	Aid Car		
<b>Other Vehicles</b>					
700	Ford Excursion	2000	Duty Officer Vehicle	2014	
1094	Chevy Pick-up	1999	Technician, Sprinkler Systems		
1204	GMC Van	2001	Technician	2012	
874	CHEVY Pick-up	1994	Fire Prevention Officer		
1270	Ford F350 P/U	2006	Training Officer		
1271	Ford F350 P/U	2006	Fleet		
1308	Ford Expedition	2006	Fleet Assigned		
1309	Ford Expedition	2006	Fleet	2016	
1310	Ford Expedition	2006	Duty FF	2016	
1311	Ford Taurus	2007	Fleet Assigned	2016	
1363	Ford Escape	2008	Fleet Assigned		
1412	Ford Escape	2009	Fleet	2019	
1413	Ford Escape	2009	Fleet	2019	
1414	Ford Escape	2009	Fleet Assigned	2019	
1530	Ford Escape	2012	Fleet Assigned		
1531	Ford Escape	2012	Fleet Assigned		
<b>Other Equipment</b>					
215	Forklift			2013	
423	Electric Scooter	1988			
1240	Trailer				
1265	Pace	2005	Cargo Trailer		
1266	Pace	2005	Cargo Trailer		

Source: Port of Seattle, 2014.

Table 7-8  
**Planned Ground Run-Up Enclosure Siting Options**  
 Seattle-Tacoma International Airport

Site options	Hardstand area (s.f.)	Enclosure area (s.f.)	Wall height	RON impacts	Notes
A (South Maintenance Area)	tbd	50,380 to 60,190	42 ft.	n.a.	Enclosure area is dependent on tug-in vs. power-in option.
B1 (Cargo 7 Hardstand)	tbd	same		Loss of one 737 position.	Site includes extensive earthwork. RON plan requires revision/restrictions.
B2 (Cargo 7 Hardstand)	tbd	same		Loss of one 737 position.	Site includes retaining wall. RON plan requires revision/restrictions.
D (Cargo 5 Hardstand)	tbd	same		Loss of Group III, Group IV, Group V options and positions.	Cargo hardstand requires revisions/restrictions.

Source: Port of Seattle, Planning Level Design and Cost Estimate Report, HNTB, 2014.

Table 7-9  
**Airport Maintenance Summary**  
 Seattle-Tacoma International Airport

Facility/function	Functions	Number of Employees
Central Docks		
Trash/recycling	Trash and recycling	To follow
Shipping/receiving docks	Receiving	To follow
Shops	Communications and electrical	35 Electrical technicians/lampers.
Central Plant	Heating, cooling, central power	52 Operating and maintenance engineers
Central Terminal Shops	Mechanical systems-baggage and vertical conveyance	38 Mechanical technicians
Concourse A shops	Mechanical- loading bridges	68 Electrical and mechanical techs
Central Distribution Center	Procurement, warehousing and distribution	13 Receiving and distribution, storage, procurement
Air cargo 4 Maintenance Bldg.	Fleet, buildings and grounds, carpenters, airfield, access and security	81 Airfield technicians, fleet technicians, carpenters
Industrial Waste Treatment Plant	Mixed stormwater and industrial sewer treatment	6 Waste treatment operations
Snow Equipment Storage	Deicing and snow removal equipment storage	Maintenance and airport staff as required
STS Maintenance	Transfer and maintenance	18 Mechanical technicians

Source: Port of Seattle, 2014.

Table 7-10  
**Snow Removal Equipment**  
 Seattle-Tacoma International Airport

Task area	Type	Size	Number
Runways and taxiways	Plows	20 ft.	3
		22 ft.	4
	Power brooms	22 ft.	11
	Power blowers		3
	Combo sweeper/plow		4
	Deicer truck	75 ft.	3
Gates , aprons, circulation	Sander/plow unit	19 ft.	3
	Power broom	22 ft.	
	Blower		2
	Deicer truck	50 ft.	1
Landside roadways	Sander/plow unit	10 ft.	5
		12 ft.	1
	Deicer truck		2
	Deicer/plow	10 ft.	2

Source: Port of Seattle, 2014.

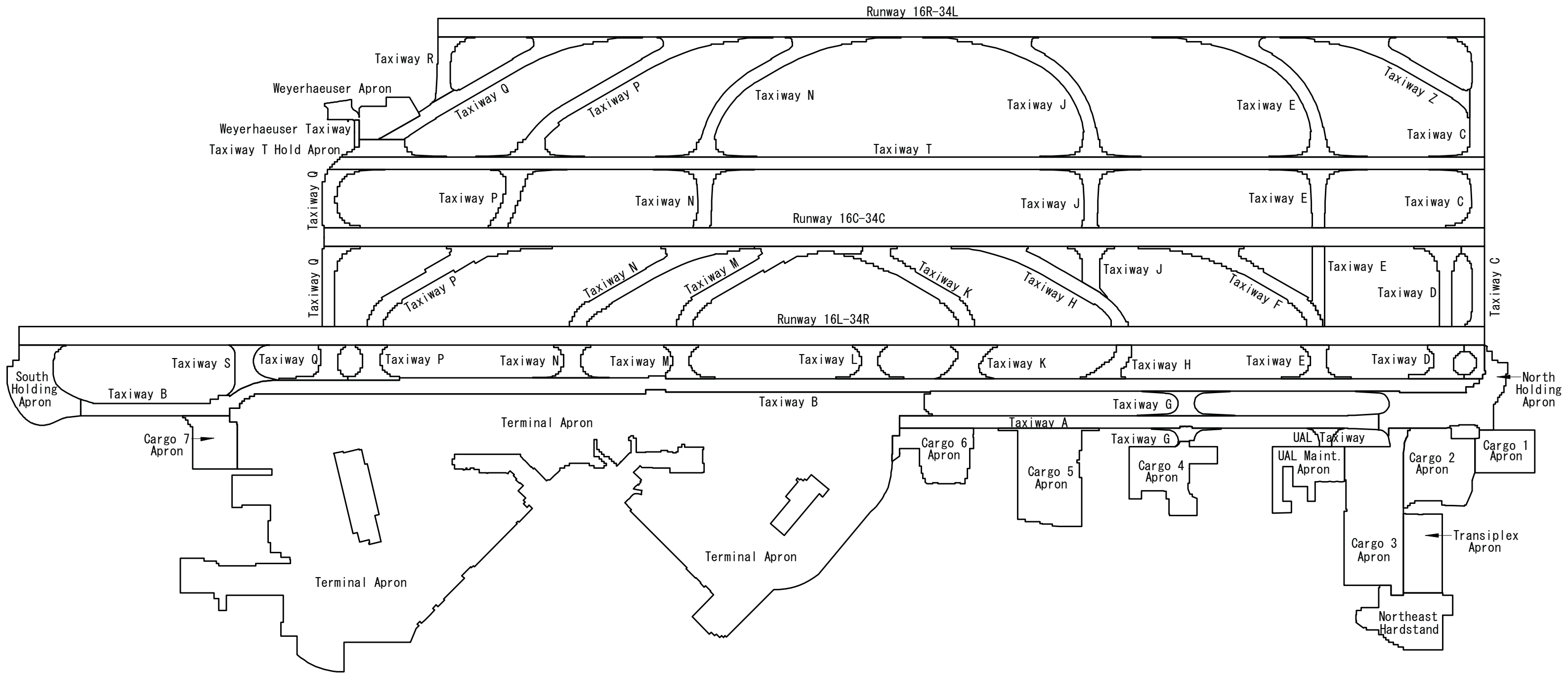


Table 7-11  
**Utilities Summary**  
 Seattle-Tacoma International Airport

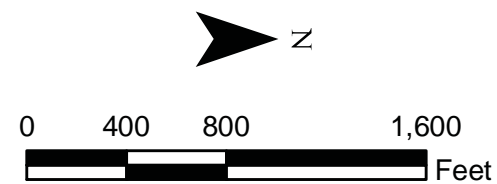
Facility/Function/Components	Gross Total Area	Equipment			Capacity (each)	Notes
		Description	No.	Age (years)		
Central Plant						Considered efficient.
Boilers		125 Lb. Steam	3	44	30,000 lb./hr.	
Boilers		125 Lb. Steam	1	5	40,000 lb./hr.	130,000 lb./hr. total
Chillers		Centrifugal Chiller	1	19	2,200 tons	
Chillers		Centrifugal Chiller	4	6	1,500 tons	
Chillers		Centrifugal Chiller	3	8	2,100 tons	14,350 tons total
Generators						
Switchgear						
Water Pumps						
Cooling Towers		Ceramic Towers 1 & 2	2	18	3,500 tons	
Cooling Towers		Ceramic Towers 3, 4 & 5	3	14	3,500 tons	17,500 tons total
Water Supply & Distribution						
Supply Pumps		Electric Pumps WPS-PE-13, 14	2	15	3,500 GPH	7,000 GPH
Generators		Electrical Generator	1	15		Power for pumps PE-10, 13, 14, Emer. Pwr. Panel & Air Compressor.
Fire Protection Pumps		Electric Pumps WPS-PE-11, 12	2	15	3,500 GPH	7,000 GPH
Fire Protection Pumps		Diesel Pumps WPS-PD-01 - 08	8	15	2,500 GPH	20,000 GPH
Water Storage Tanks		On Ground Potable Storage	1	15	2 million gallons	
Industrial Waste Plant		8.3 Mgd capacity, 3 lagoons, 22 miles of conveyance piping	1	15	80 million gallons	
Sanitary Waste Triculator						
International Blvd. Electrical Substation			1	13	25 MW	
S 188th St. Electrical Substation			1	12	25 MW	
No. Airfield Lighting Vault			1	13	2 MW	
Aircraft Ramp Systems		400 HZ POWER	3	1	1.2 MW	SSAT
		400 HZ POWER	2	10	0.6 MW	NSAT
		400 HZ POWER	3	11	0.9 MW	Concourse A
		400 HZ POWER	0	0	0.0 MW	Concourse B IN 2016
		400 HZ POWER	1	8	0.3 MW	Concourse C
		400 HZ POWER	1	9	0.3 MW	Concourse D
Pre-conditioned Air		Central System Plant and 73 gates equipment	1	1		Provides heating/cooling for all gates.

Source: Port of Seattle, 2014.

Appendix A  
Airfield Pavement Management Program



**Figure 1. Airfield Pavement Layout.**  
**Airfield Pavement Management Program**  
**Seattle-Tacoma International Airport**



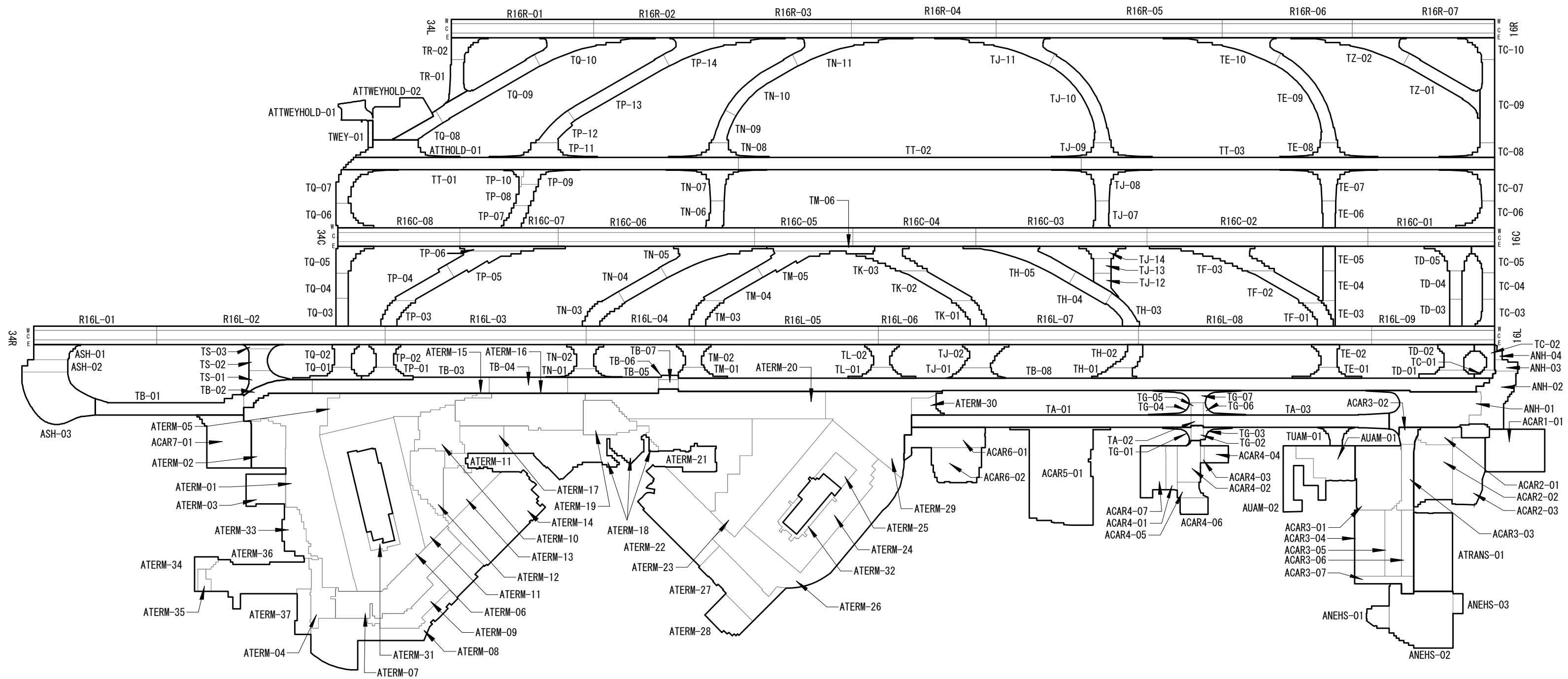


Figure 3. Branch and Section Layout.  
 Airfield Pavement Management Program  
 Seattle-Tacoma International Airport

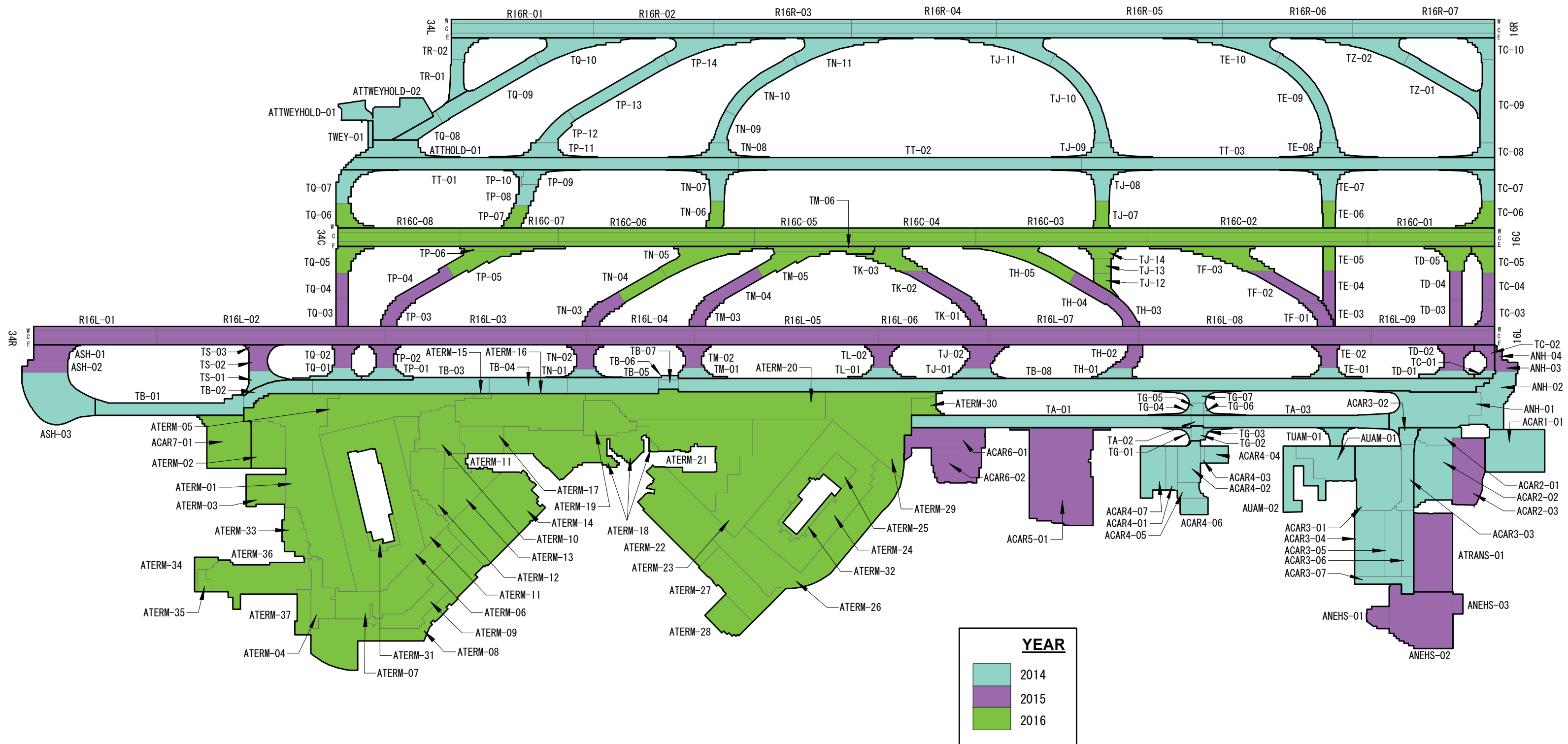
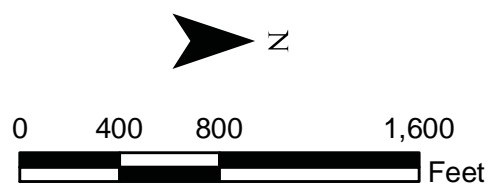
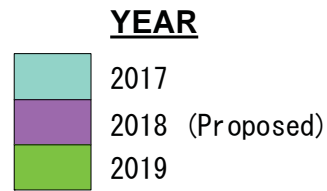
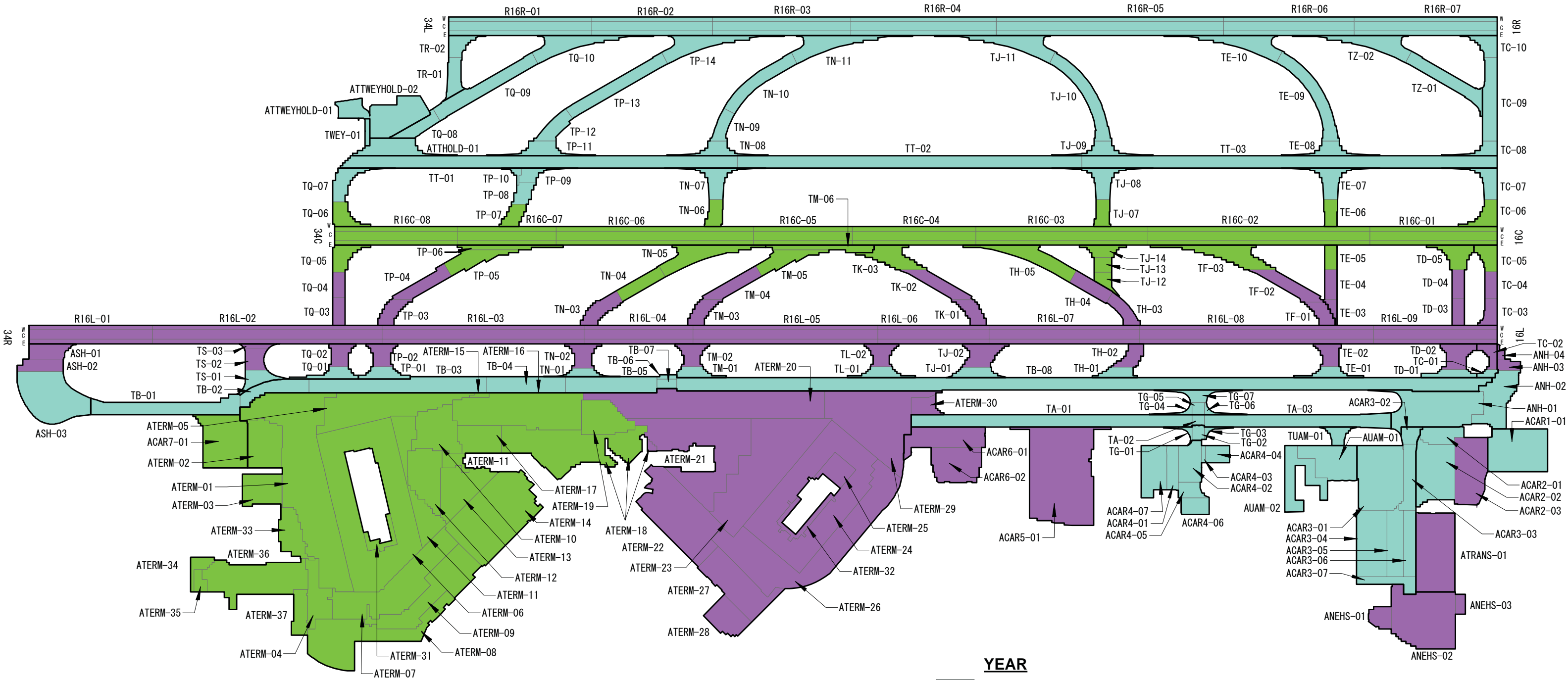


Figure 5. Year Last Inspected.  
 Airfield Pavement Management Program  
 Seattle-Tacoma International Airport



## Proposed Year For Inspection Airfield Pavement Management Program Seattle-Tacoma International Airport

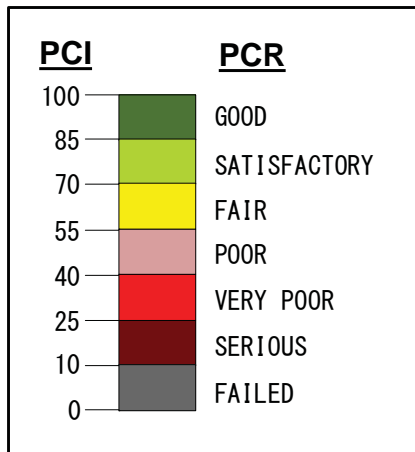
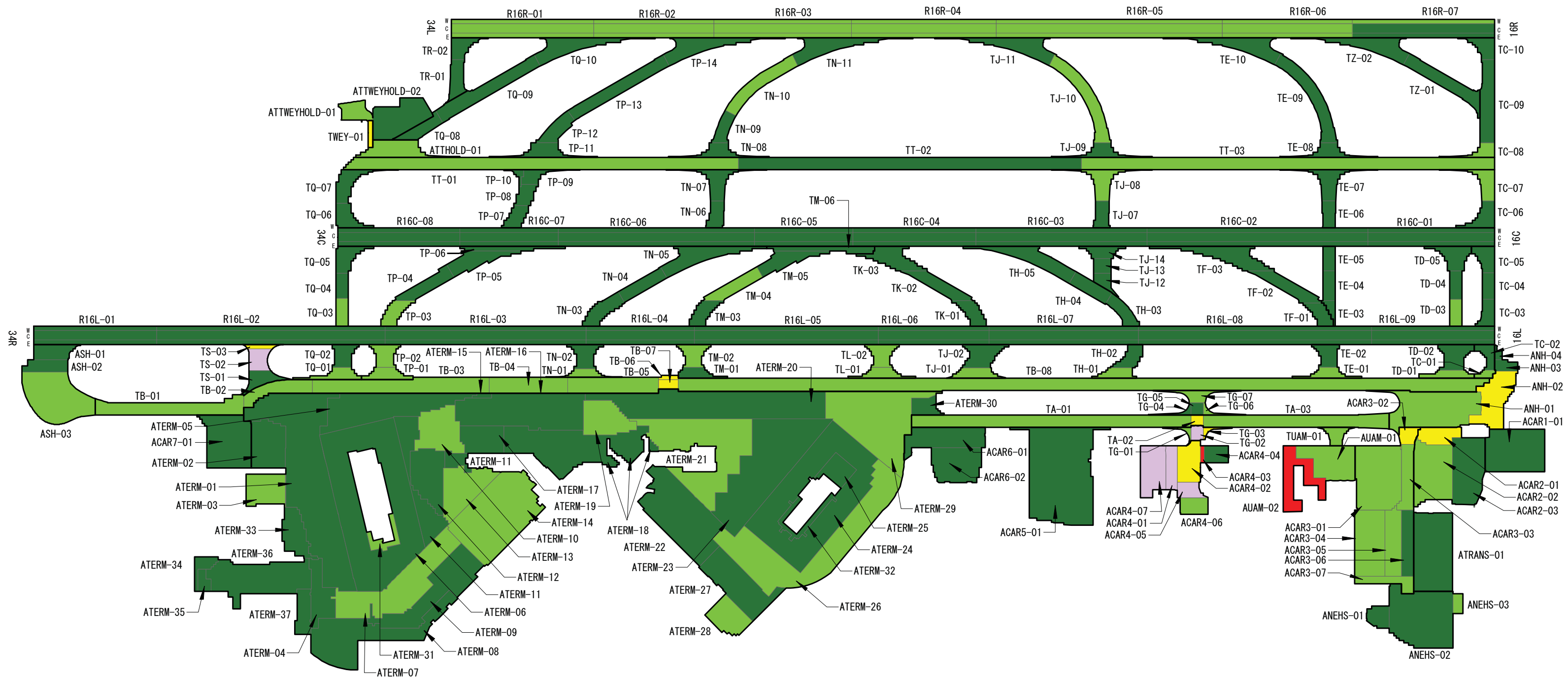
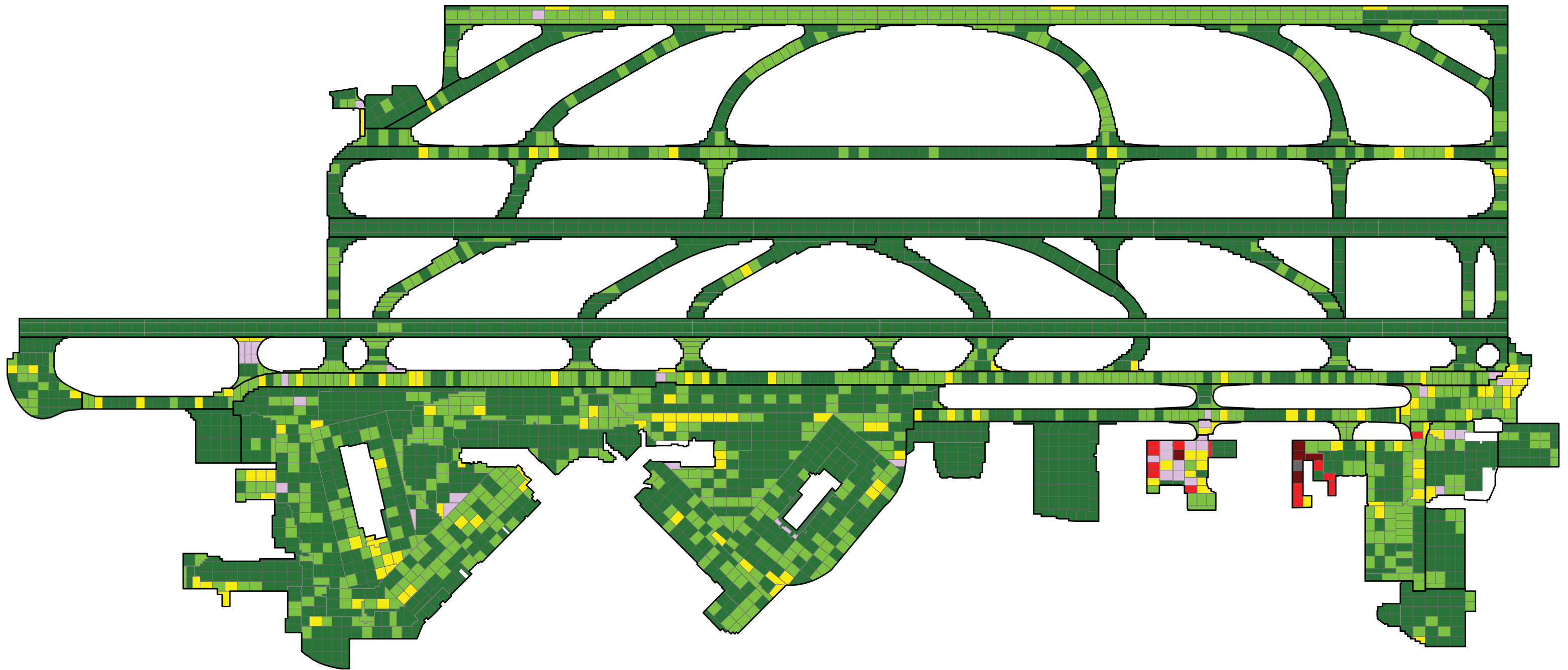


Figure 6. Pavement Condition at Last Inspection.  
 Airfield Pavement Management Program  
 Seattle-Tacoma International Airport



PCI	PCR
100	GOOD
85	SATISFACTORY
70	FAIR
55	POOR
40	VERY POOR
25	SERIOUS
10	FAILED
0	



0 400 800 1,600 Feet

Figure 8. Sample Unit Condition at Last Inspection.  
Airfield Pavement Management Program  
Seattle-Tacoma International Airport



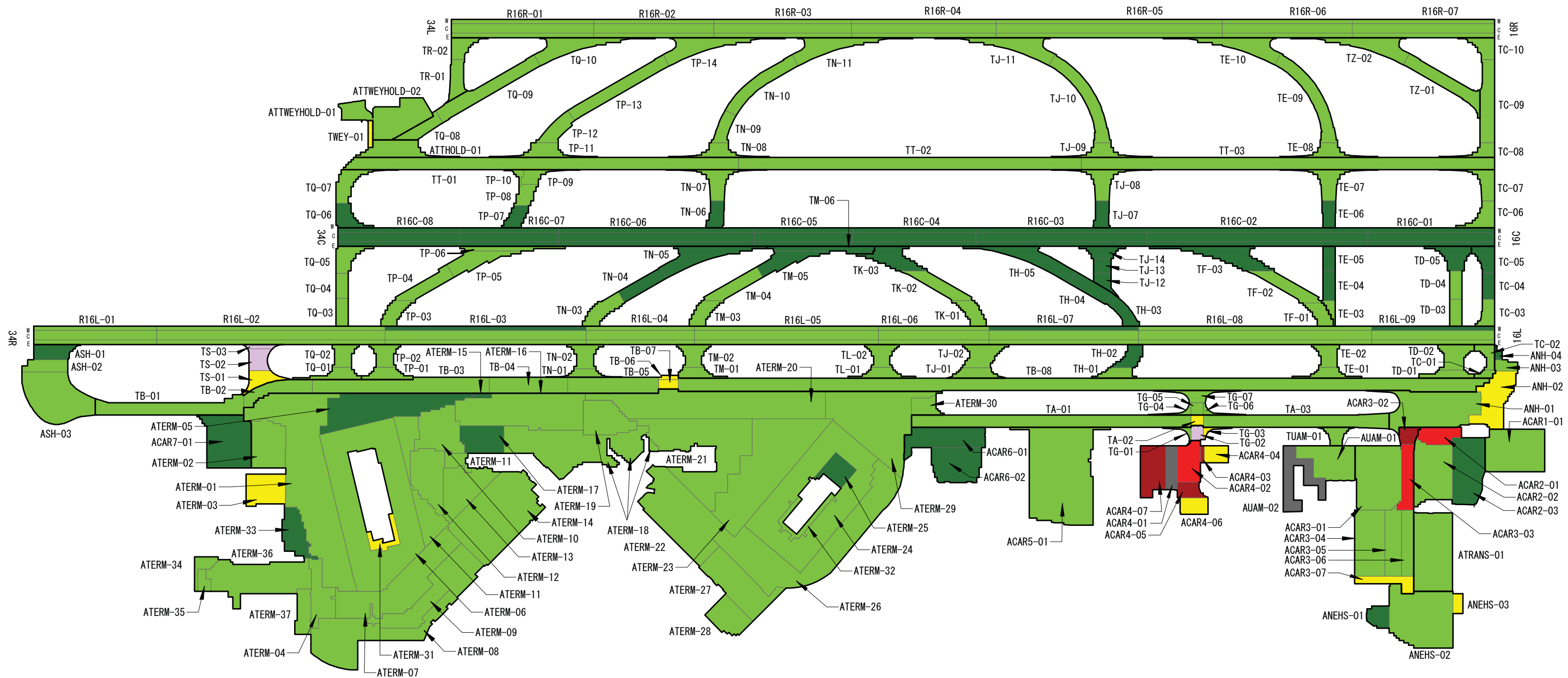


Figure 13. Predicted Pavement Condition in 2021 if Only Routine Maintenance is Completed. Airfield Pavement Management Program Seattle-Tacoma International Airport

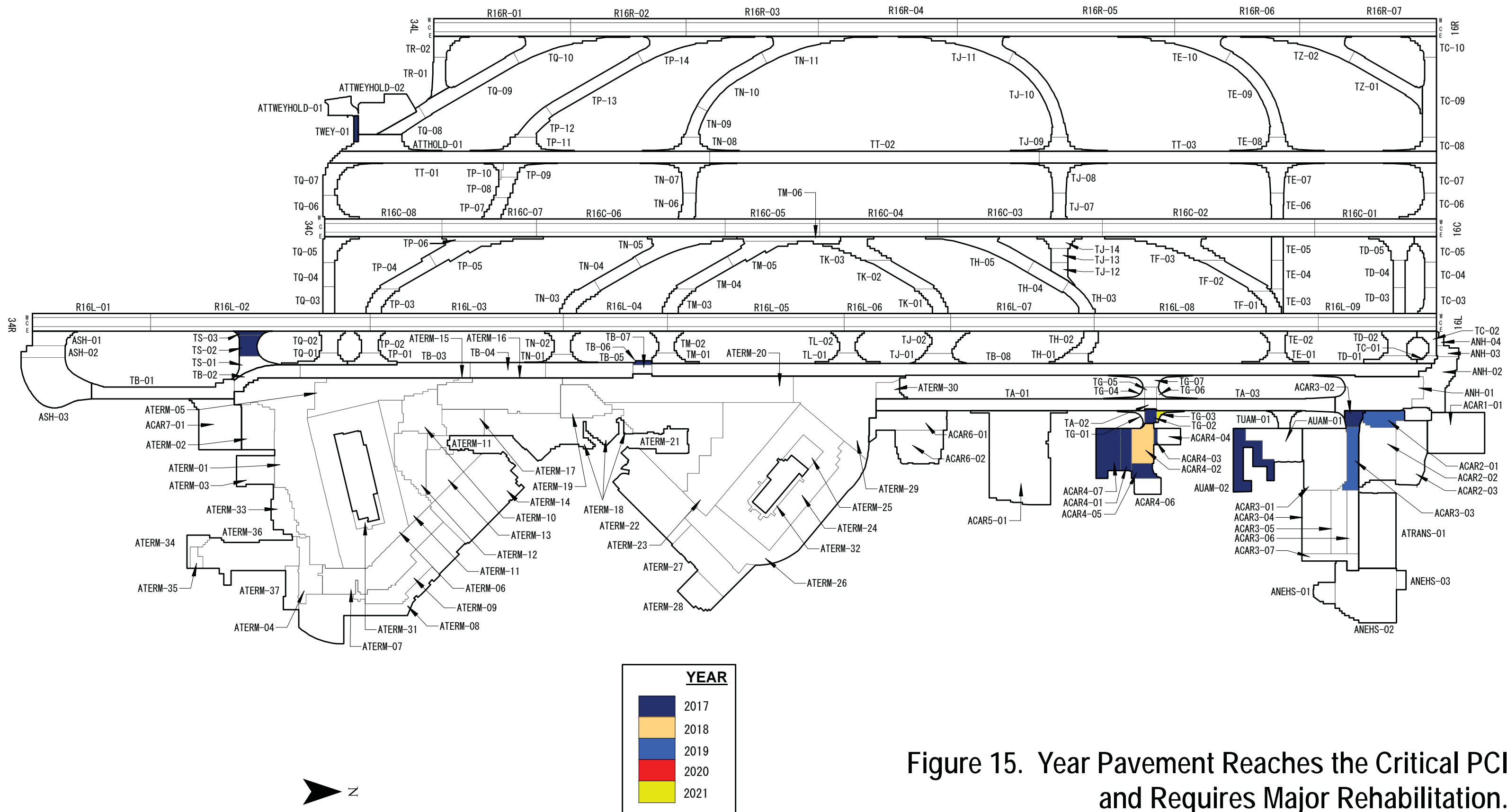


Figure 15. Year Pavement Reaches the Critical PCI and Requires Major Rehabilitation. Airfield Pavement Management Program Seattle-Tacoma International Airport

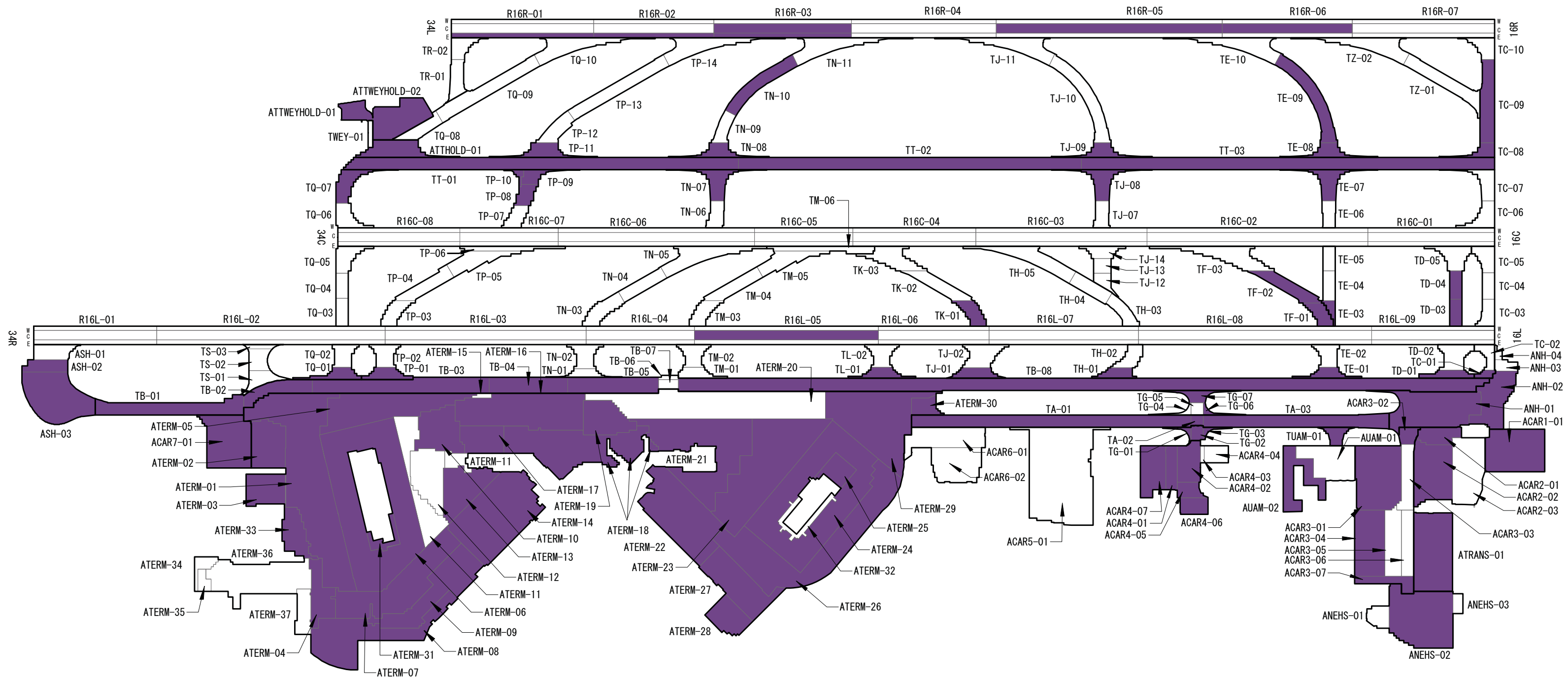


Figure 16. Sections Requiring Joint Resealing.  
 Airfield Pavement Management Program  
 Seattle-Tacoma International Airport