



The Future of Energy Storage

Towards A Perfect Battery with Global Scale

by Gene Berdichevsky, CEO & Gleb Yushin, CTO

Sila

September 2, 2020

Executive Summary

- In the next 5 to 10 years, we will see a \$50 per kilowatt-hour (kWh) lithium-ion (Li-ion) battery cell that's capable of fast charging, 10,000+ cycles, 1 million+ miles, a 30 year calendar life, and produced with abundant raw materials found all around the world and recycled
 - Although there are some claims of these attributes now, the challenge is putting it all together in a single cell, without the compromising trade-offs inherent in batteries (for example, a 1 million mile battery is no good if it costs \$200/kWh). Achieving the combination will take 5 to 10 years of global innovation
- The most innovative period for energy storage technologies is just beginning and will run for the next 10 years
- From 2030 to mid-century, these new technologies will scale at a rate and to a size the world has rarely seen - we need tremendous scale to displace fossil fuels
- This transformation will be driven by the demands of electric vehicles (EVs), further accelerated by autonomous vehicles and storage for intermittent renewables. This will require a growth of global battery production from 20 GWh per year from pre-EV days to 2,000 GWh per year by 2030, and 30,000 GWh per year (over 1,000 times more!) for a world with All EVs and a Renewables-based global energy and transportation system by 2050
- Li-ion won't be everything, but Li-ion will be everything that matters. Non Li-ion chemistries may find niche applications, but will remain small on a relative scale to Li-ion technology
 - Solid state batteries are likely to be irrelevant to the revolution, a niche player at best
- The transformation of energy storage will be powered not by policy but by better technology, products, and economics. Strong national technology and manufacturing policies can help accelerate the change though, as well as create long term structural economic benefits
- The future of storage innovation will come in two main forms - new materials technologies and battery manufacturing process innovations
 - The first linchpin of Advanced Li-ion is the Silicon Anode. It'll require a solution that uses:
 - A technology that can replace graphite entirely, even if it starts as a hybrid
 - Advanced engineered particle design to overcome key swelling challenges
 - Novel, bulk manufacturing technology to produce this design at industrial scale
 - Only global commodity inputs so it can be scaled to millions of tons at low cost
 - The silicon anode will enable leverage from other new material innovations:
 - Abundant iron and possibly copper will replace scarce nickel and cobalt in cathodes
 - Ceramic separators will replace today's polymer separators
 - Advanced liquid electrolytes will extend cycle life and reliability
 - In addition to new materials and chemistry, new manufacturing processes will allow for:
 - Elimination of environmentally unfriendly organic solvents from use
 - Engineered electrode replacement of today's randomly cast electrodes
 - Re-imagining of cell assembly, formation, aging, and pack integration
- New Li-ion technologies will greatly impact not only the automotive, but also the consumer electronics markets. The consumer market can adopt new technology sooner due to smaller scale, less demanding product requirements, and customers' strong dissatisfaction with current battery performance. Technologies compatible with both markets have the best chance to succeed, since consumer electronics value the improvements more and create a path towards launching into the automotive market.
- The dominant automotive cell makers today (CATL, LG, Panasonic, Samsung, and SK) may be shaken up by new entrants, but control their own destiny if they quickly adopt the technologies compatible with their

existing Li-ion manufacturing processes. Some new cell makers will join their ranks, and can become leaders in the field if the incumbents take a slow approach to new technology

- With scaling of battery production to 2,000 GWh, there will be ~100 million EVs on the roads by 2030
- The rapid acceleration of electric vehicle adoption in the middle of this decade will cause major havoc for automakers who don't go all-in on electrification now. It's likely many won't move soon enough, and the half that try to join the EV revolution later will be at major risk of bankruptcy
- By mid-century, these breakthroughs in energy storage will pave the way for increased adoption of renewable energy generation and decarbonization of the world economy, transforming the transportation sector, and freeing countries to use domestic wind and solar resources to power their energy needs

Prices of Mass Market Li-ion Cells

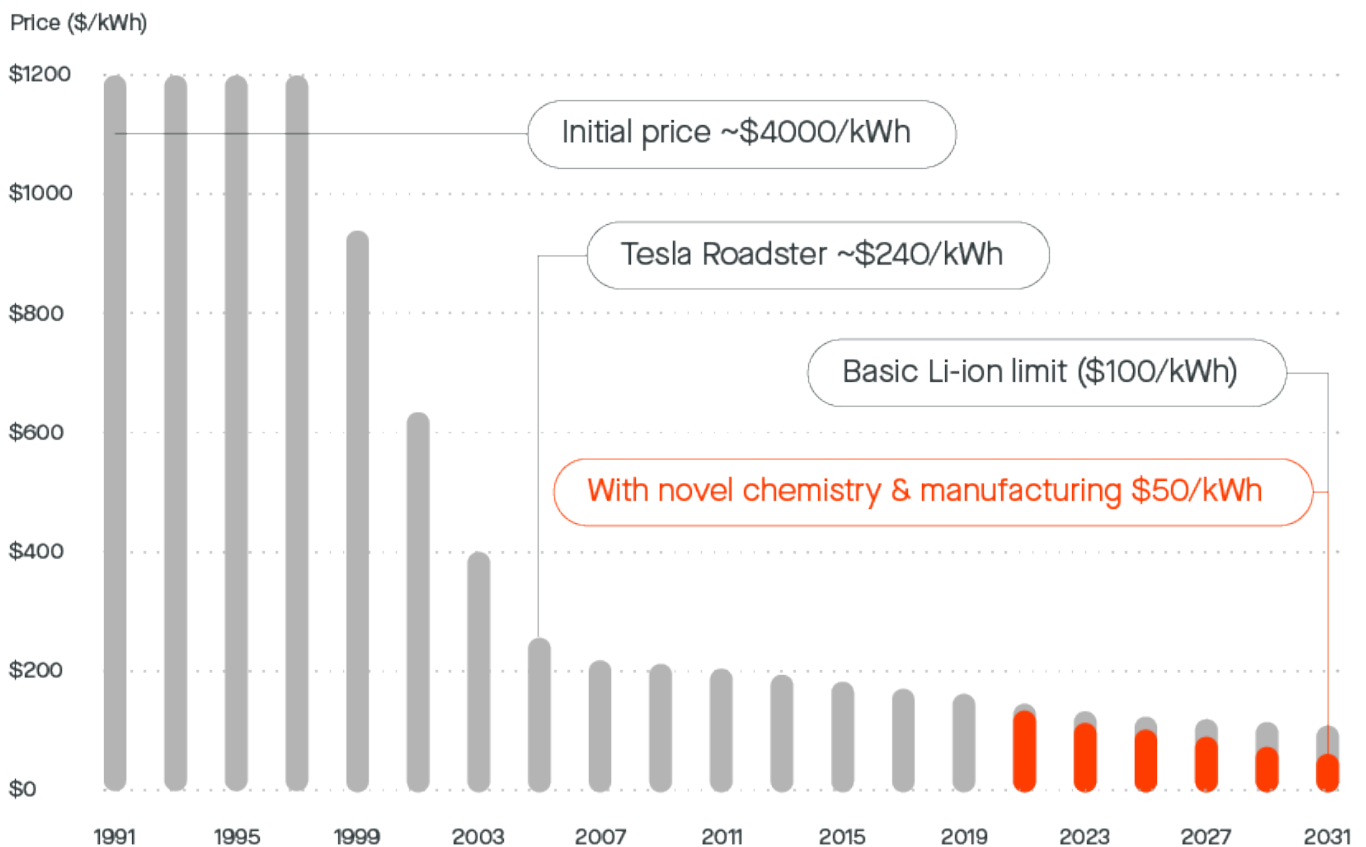

Source for historical numbers: H. Takeshita

Figure 1. Prices of Li-ion batteries fell dramatically in the late 90's and early 2000's, particularly in the 18650 cylindrical cell form factor which was produced by the billions of units and used in nearly all laptops. Tesla used that commodity laptop cell to build the first modern EV.

Introduction - A Vision of the Future

Our world was transformed in the last three decades by the invention of a device that nearly everybody on earth carries in their pockets today. This device has been produced by the billions every year, and may well reach production volumes in the trillions per year by mid-century. That device is, of course, the humble Li-ion battery.

As much as we think about the current era of technology being defined by the mobile phone, which in turn was enabled by semiconductors, radios, and the internet - this world of mobility would not have come to be if not for the inventions of Goodenough, Whittingham, and Yoshino who were recognized with a Nobel Prize in chemistry last year for the invention of the basic Li-ion battery in the late 1970s & early '80s.¹

Since its commercial introduction in 1991, Li-ion battery technology has improved its ability to store energy by a factor of four over the battery technologies that came before it. If not for these improvements, you could imagine your phone lasting until lunch-time before needing a recharge or being the size of a laptop. Similarly, you could imagine your laptop, which is almost entirely battery beneath the keyboard, weighing so much that you might as well leave it on the desk and never move it. We simply wouldn't have the mobile and connected world we have today without Li-ion.

In the future, the Li-ion battery will not only take billions of people to places on the internet, but also in the physical world, by land, and in some cases by sea, and air. Modern electric cars have already shown us a taste of what's possible, but another 2X reduction in price (Fig. 1), 2X improvement in energy storage (Fig. 2), 3X increase in charge speed, and 10X increase in longevity are possible, and will accelerate the shift away from fossil fuels towards renewables. In this paper, we discuss the key innovations we expect our industry to undergo this decade, and the implications they will have on our world.

Future of Advanced Li-ion

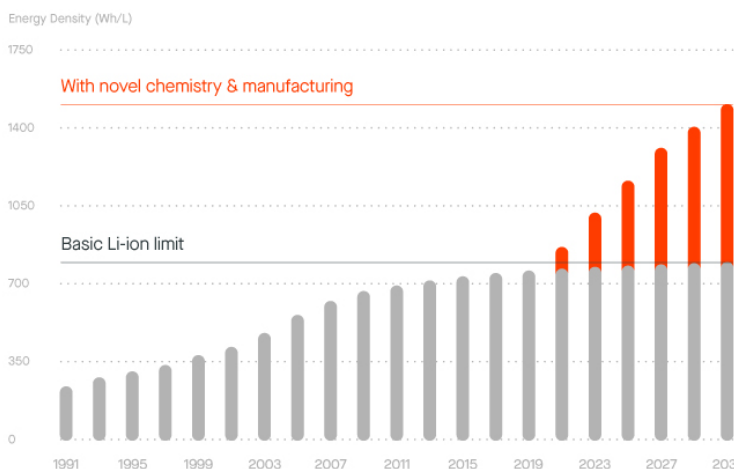

Source for historical numbers: H. Takeshita

Figure 2. Energy density increases allowed cells to store more charge while mass manufacturing scale reduced cell costs. The combination created a power driver of lowering \$/kWh prices. However, the chemistry used today has reached its limits and a new technology curve is required.

How We Got Where We Are Today (History)

There are hundreds of rechargeable battery chemistries that have been discovered and tested in academia and dozens that have been commercially developed in some form (many never made it into full production) since the first battery was introduced by Alessandro Volta about 200 years ago. However, only four rechargeable chemistries have had major commercial relevance. Each of these four chemistries - lead acid, nickel cadmium, nickel metal hydride, and conventional Li-ion (intercalation-type) - required scientific breakthroughs and immense commercialization efforts. The future, fifth chemistry, advanced Li-ion, will require more of the same.

¹ Besides John Goodenough, Stan Wittingham, and Akira Yoshino, there were many brilliant scientists and engineers whose insights were required to make the technology practical and commercial, including Michel Armand, Doron Aurbach, Samar Basu, Peter Bruce, Yet-Ming Chiang, Jeff Dahn, Kristina Edström, Robert Huggins, Ned Godshall, Arumugam Manthiram, Koichi Mizushima, Linda Nazar, John Newman, Yoshio Nishi, Emanuel Peled, Jean-Marie Tarascon, Michael Thackeray, Richard Yazami, and many more we didn't list here.

Batteries have always carried trade-offs. Many times new technologies that show promise in one performance area cause issues in another - which has kept most innovations in university labs. The most important innovations are ones that can improve multiple performance parameters at once without breaking already excellent performance in other areas.

Once Li-ion technology came to market, its higher performance made it the premium choice over nickel metal hydrides. At first the cost was prohibitive for most applications, but as cell manufacturing began to scale, Li-ion went through a tremendous period of performance improvement coupled with cost reduction, starting in the late 90's. The cost improvement slowed down in the mid-2000's as the most commonly produced 18650 form factor fell out of favor and more expensive customized pouch cells for each new gadget became the norm and as cobalt and nickel prices temporarily increased. But cost reductions picked up again as the sheer scale of EV shipments pushed cumulative historical production over 100,000 MWh in 2010. Inspired by Swanson's Law,^{2,3} which tracked and predicted the massive decline in the cost of solar, we compiled data from a myriad of data sources along with our own industry experiences to take a historical look and make a prediction where the cost of Li-ion technology will go with scale. The recent flattening of the cost curve, despite faster and faster growth in production, indicates that something more than volume scaling of Basic Li-ion chemistry will be required to continue lowering the cost of batteries and accelerating adoption of EVs. We need innovation to reach a goal of getting 100 million electric cars on the road by 2030 (Fig. 3).

Li-ion Manufacturing Learning with Scale

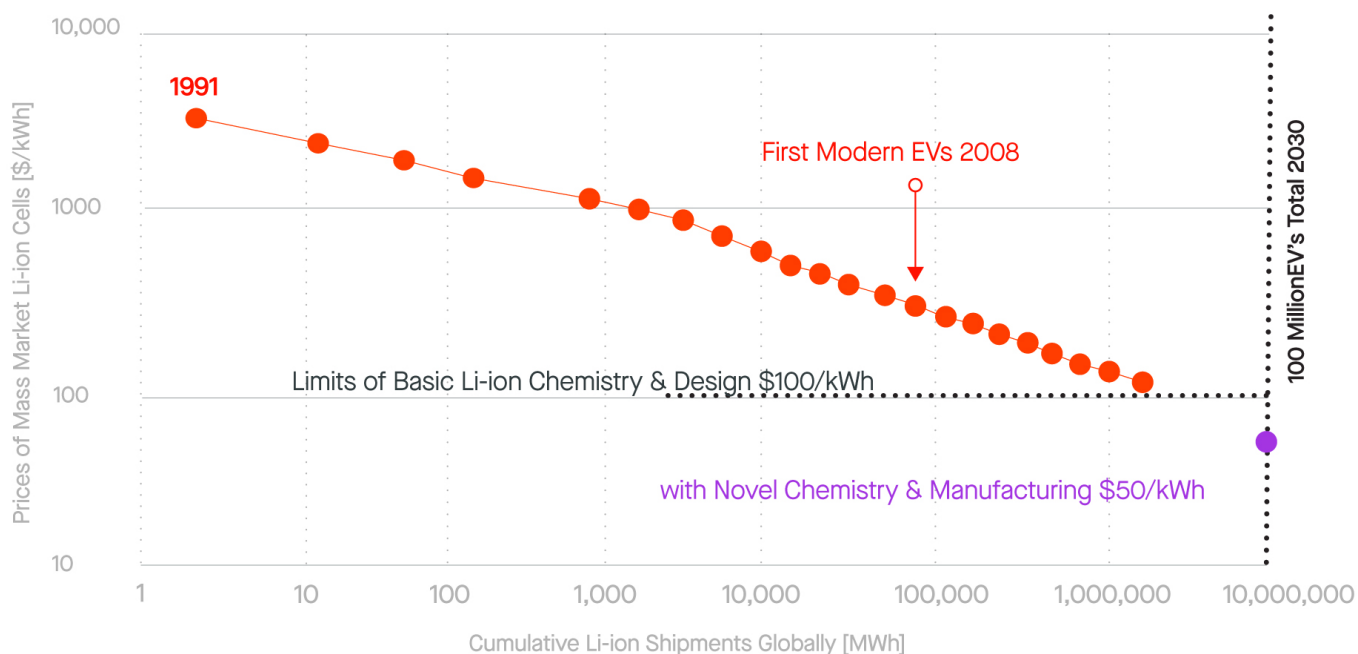

Figure 3. The manufacturing learning curve for conventional Li-ion is flattening out even as scale is reaching previously unfathomable quantities.

2 https://en.wikipedia.org/wiki/Swanson%27s_law

3 Swanson, R.M. (2006), A vision for crystalline silicon photovoltaics. Prog. Photovolt: Res. Appl., 14: 443-453. doi:10.1002/pip.709

Limitations and Tradeoffs of Today's Li-ion Batteries

Conventional Li-ion batteries today (Fig. 4) can be produced at around \$100/kWh, have an energy density of over 720 Wh/L, last 10 years, complete up to 5,000 full charge - discharge cycles before degrading, and recharge in as little as 10 minutes. But there's a catch: none of today's batteries can achieve all these parameters at the same time.

The most important parameters in Li-ion batteries are in tension with each other: any Li-ion battery produced must compromise some performance areas in favor of others. This is also why so many comparisons made in our field are misleading or wrong - essentially comparing apple and orange flavors of Li-ion to each other.

Of all the parameters, \$/kWh is prioritized above all else, especially for EV applications, while other parameters like cycle life and power need to only meet a modest threshold. This is because \$/kWh dictates the cost of the battery systems, which is the largest, most expensive, and most important component of the EV. The battery pack in turn dictates the most important parameters of the car - its range, acceleration, recharge time, safety, and of course cost. And so the innovations we discuss below, even ones focused on increasing energy density, are always judged by their ability to reduce cost on a \$/kWh basis.

The Basics and the Tradeoff. To simplify the breakdown of Li-ion compromises, it is useful to consider the two main flavors of Li-ion batteries: energy cells and power cells. Most of the compromises in Li-ion can be boiled down to one major tradeoff which results in these two types of optimized cells. The first type of cell favors cost and energy density (like Panasonic's cells) which we can call the Energy Cell. The second type of Li-ion battery favors cycle life and charge speed (like CATL's lithium iron phosphate cells) which we can call the Power Cell. There are other nuances which we cover below, but this tradeoff is the core compromise that needs to be broken for advanced Li-ion technology to reach its full potential. You can also produce intermediate versions that blend the benefits, but they also blend or combine the downsides.

Before discussing the two types of cells in more depth, let's cover Li-ion battery basics, starting with the name (Fig. 5, 6). "Lithium-ion" is a very broad overarching term that says that lithium, in its ionized (positively charged) form, is the energy carrier in the system. That energy carrier, however, needs a home when it is not being actively charged or discharged, which are the anode and cathode materials. Any cell that uses lithium as the energy carrier can be termed "lithium-ion" including cells that are colloquially termed "Li-ion," "LCO," "iron phosphate or LFP," "NCA," "NCM," "lithium metal," "solid state," "solid electrolyte," etc. which often refer to the key distinguishing

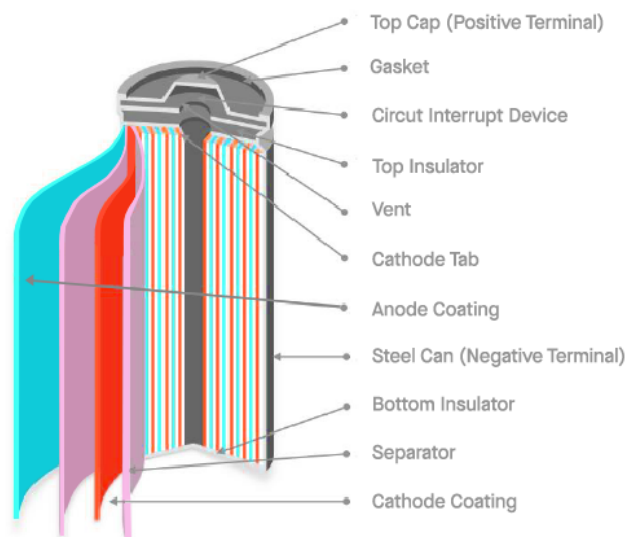

Figure 4. Cross section of a typical cylindrical Li-ion cell shows how the electrodes are layered and then wound.

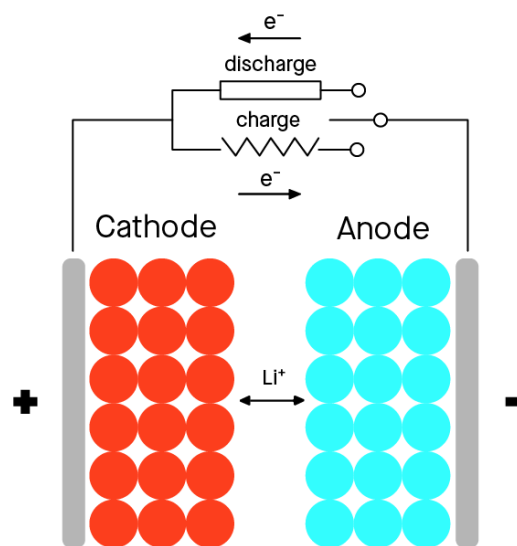

Figure 5. Basic operation of a Li-ion cell involves lithium atoms moving in their positively charged (ionized) state from anode to cathode during discharge and vice versa during charge. The movement happens and via the liquid electrolyte through the porous separator. Meanwhile the lithium atoms' electrons move through the

component of the battery, and imply that the rest of the components are of the most standard Li-ion variety. We cover the difference below (Fig. 7).

Conventional, basic Li-ion batteries operate by what is called an “intercalation” mechanism, where lithium atoms (in the form of ions) are inserted (intercalated) into small openings within a crystalline anode material during charge; and then leave those to move into small openings within crystalline cathode materials during discharge.⁴ No breakage of chemical bonds and no major volume changes are taking place during these processes, making them almost perfectly reversible. To borrow an often used analogy, the anode is an auditorium where lithium ions take their seats when the battery is charged - and the cathode is a second auditorium across the hall where the lithium ions move to and take their seats as the battery is discharged (we will use this somewhat imperfect but useful analogy again).

For the anode, there is only one material meaningfully used in Li-ion batteries today – graphitic carbon. Some 99% of the Li-ion anode market consists of a few types of graphite.

For the cathode, there are two main families of conventional materials used for automotive Li-ion, with a couple of subtypes of the first family. They are: (i) the higher-voltage, higher-capacity Ni-rich lithium nickel cobalt aluminum oxide (NCA) or lithium nickel cobalt manganese oxide (NCM)⁵ and (ii) the lower-voltage, lower-capacity lithium iron phosphate LiFePO_4 (LFP).⁶ Despite much higher costs of nickel and cobalt metals compared to iron, the NCA and NCM-based Li-ion battery cell is 1.3-2x smaller for the same energy (i.e. on a Wh/L basis) and ~25% cheaper (on a \$/kWh basis) than the LFP-based battery cells because of the much lower energy densities of the LFP. In effect, despite the fact that each cell made with NCA or NCM is more expensive, which increases the numerator “\$”, those same cells have an even higher denominator increase in energy “kWh”; which combines for a lower \$/kWh cost of energy storage.

The Energy Cell. Today’s best Energy Cell can achieve a few of the excellent properties we described at the start of this section: 720 Wh/L energy density & ~\$100/

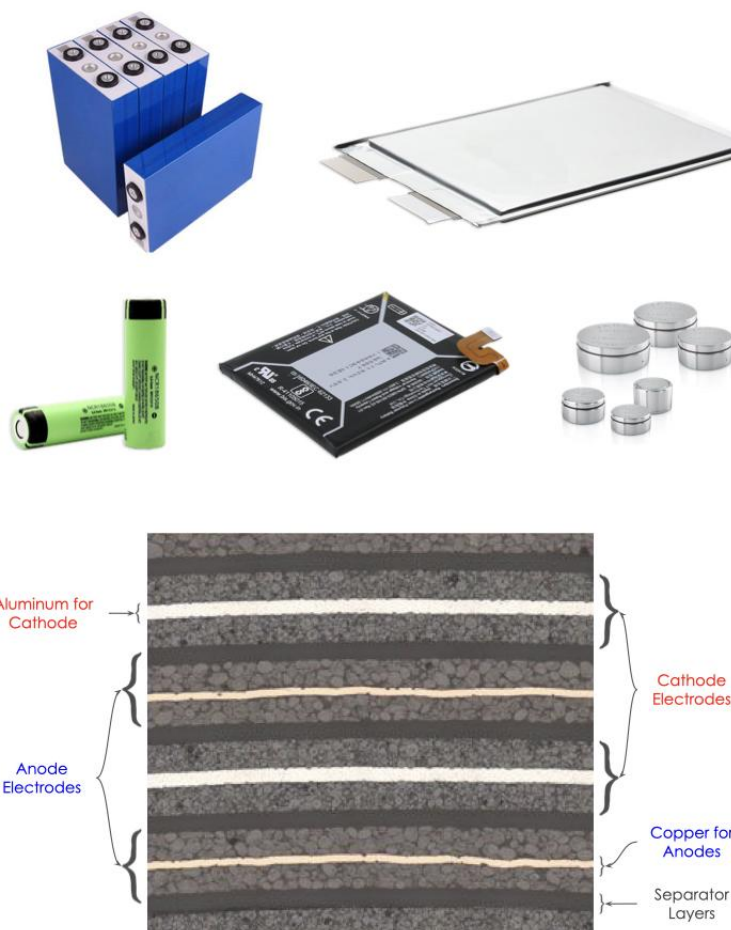

Figure 6. Top 5 images show different form factors of Li-ion cells. Prismatic and pouch for automotive markets; cylindrical, pouch, and coin for consumer markets. Regardless of the form factors or applications of Li-ion batteries, the optical cross-section image (bottom) is representative of the layered construction found in all Li-ion cells today cells.

⁴ N. Nitta, F. Wu, J.T. Lee, G. Yushin “Li-ion Battery Materials: Present and Future” *Materials Today*, 18(5) p. 252-264, 2015 (DOI:10.1016/j.mattod.2014.10.040)

⁵ T. Kim, W.T. Song, D.Y. Son, L.K. Ono, Y.B. Qi, “Lithium-ion Batteries: Outlook on Present, Future, and Hybridized Technologies” *Journal of Materials Chemistry A*, 7(7), p. 2942-2964, 2019 (DOI:10.1039/c8ta10513h)

⁶ J.J. Wang, X.L. Sun, “Olivine LiFePO_4 : the Remaining Challenges for Future Energy Storage” *Energy & Environmental Science*, 8(4), p. 1110-1138, 2015 (DOI:10.1039/c4ee04016c)

kWh production cost. They are, however, unable to reach 5,000 full charge/discharge cycles, becoming degraded after about 1,000 full cycles or full cycle equivalents. That means for a 200-300 mile EV, you'll start to have significant degradation by 200k-300k miles.

These cells, in the automotive field, use the NCA or NCM (typically NCM-622 or more recently NCM-811, where the numbers represent for the relative ratios of nickel, cobalt, and manganese, i.e. 8:1:1 ratio uses less cobalt than the 6:2:2) cathodes paired almost in all cases with a graphite anode. The best energy cell in production as of this writing appears to be the Panasonic 2170 used by Tesla. Along with using the highest nickel content (to drive up the capacity of the cathode) the cell also sprinkles in about 5% silicon into the graphite anode to increase the anode capacity. By creating the highest energy density cell of 720 Wh/L, it also turns out to be the cheapest. The reason is simple - we measure costs on a \$/kWh basis, so as the energy storage of the cell goes up (kWh) that lowers the \$/kWh even if the cost of the cell itself stays relatively flat. The more energy you pack in a cell, the lower the \$/kWh becomes. Designing for energy, however, makes the cycle life and charge rate of the battery worse for a couple of reasons we will cover next.

The Power Cell. Today's best Power Cell can achieve the other good state of the art properties we described at the start: 5,000 charge discharge cycles and a 10 minute recharge. These cells, however, are unable to reach the same cost as the energy cell - hovering 25-50% higher on a \$/kWh basis - and only boast an energy density of 450 Wh/L, which pales in comparison to the 720 Wh/L of the Energy Cell. The pairing of the power cell's benefit of high charge speed and its drawback of low energy density can be explained by furthering our auditorium analogy. Imagine, compared to the NCA and NCM auditoriums, that the LFP auditorium is the same size, but has only a third as many seats installed. Every other seat has been removed creating an aisle between every single chair. This makes it far easier for all of our people (lithium ions) entering the auditorium to RUN to their seats without much trouble. At the same time, because there's half as many seats, the auditorium holds half as much charge.

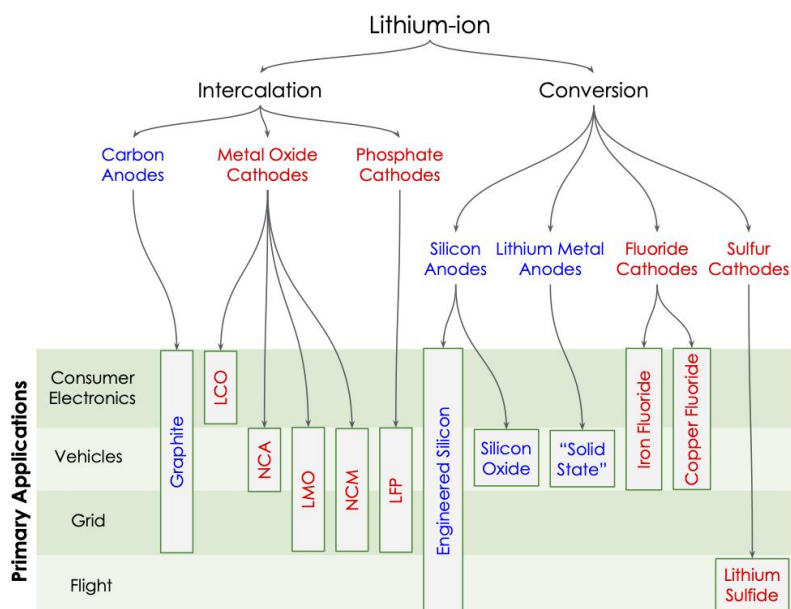

Figure 7. The Li-ion family tree. Note that any anode and any cathode can work together to make a proper Li-ion cells. The next step for automotive cells will be to replace the graphite with engineered silicon anodes.

Despite the cost per kWh and low energy density drawbacks, the Power Cell has been a very popular choice for EVs in China, to the point that even Tesla is rumored to be launching with it in the China market in 2021. It can also be the best choice for grid applications in many cases. There are four main reasons why, despite inferior energy density and cost per kWh performance, LFP cathode chemistry is re-gaining popularity:

- First, there are supply limitations with both nickel and cobalt needed for NCM and NCA. There is not enough cobalt and nickel supplies for full electrification of transportation at prices that are economically profitable for mining. The expected depletion of these high-grade ores in the next 10-20 years will create price volatility and lead to overall higher prices of these already rather expensive metals.⁷ In addition, most cobalt and nickel mines are located outside the major EV markets of North America, Europe, and East Asia. Some of these mines are located in countries with poor labor practices such as Congo.⁸

⁷ <https://www.nature.com/articles/d41586-018-05752-3>

8 <https://www.washingtonpost.com/graphics/business/batteries/congo-cobalt-mining-for-lithium-ion-battery/>

- Second, the lower voltage of LFP minimizes electrolyte oxidation on the cathode and enables a longer calendar and cycle life (even with simplified cooling) for this chemistry. While the current batteries with 300k+ mile lifetimes are more than sufficient for consumer EVs, the emergence of autonomous vehicles, buses, and trucks will create a demand for million+ mile batteries which LFP can achieve (e.g. 200 mile range X 5,000 cycles = 1M miles). The rapid expansion of grid storage will similarly contribute to demand where 5,000 cycles is good for 15 years of near daily use.
- Third, the LFP cell is less prone to “thermal runaway” - the technical term for a battery that catches fire from its own energy - and its high power capabilities allow it to run cooler in normal operations because there is less internal resistance to cause self heating. These factors combine to allow battery packs made with LFP cells to operate with dramatically simpler cooling technologies, lowering pack overhead costs, weight, and battery management system complexity.
- Finally, the gradual reduction in cell manufacturing costs will make cathode materials’ costs the most dominant factor determining the final cell price. As a result of all these factors, LFP battery packs may become priced competitively with NCA and NCM based ones; and even cheaper if nickel or cobalt prices climb due to shortages.

The Opportunities - Next Generation Chemistry & Materials

The theoretical limits of a battery’s performance are always limited by the key components - the anode, cathode, electrolyte, and separator. The practical realization of these performance goals, however, is limited by excellence in manufacturing. This section covers the innovations expected in the components of a Li-ion battery. We will cover the manufacturing innovations in assembling these components in the section that follows.

Advanced Anodes - Silicon. The single biggest near term advanced Li-ion breakthrough that will make an impact will be silicon anodes. Because graphite is the weak link in a battery taking up more space than any other component, silicon anodes will unlock not only big gains, but also opportunities for other innovations to have a big impact.

Basic (intercalation-type) anode material is graphite, typically used as a mixture of natural and synthetic graphites. The emergence of ultra-high capacity silicon (Si) anodes that can replace graphite entirely increases Li-ion cell energy density and has the potential to reduce Li-ion battery cost significantly, especially in the Energy Cell (Fig. 8).

Silicon does not store lithium ions using an intercalation mechanism. Instead, it operates by a so-called “conversion” mechanism, where silicon and lithium atoms form electrochemical alloys, breaking and restoring chemical bonds during charge-discharge cycling. The conversion name comes from converting or transforming from one structure to another. Think of the basic intercalation reaction as stuffing a patch of fabric (the lithium atom being intercalated) into a shirt pocket and then removing it; in the same way, think of a conversion reaction as stitching several entirely new large patches of fabric into the shirt and then cutting them out each time. The bonds made in conversion reactions are much stronger (which is why they store more energy), but are harder to make and break in a repeatable way without long term damage.

Attaining Si anode cycle-ability is technically more challenging. The first academic insights were made in 1953-1956^{9,10} and the first modern commercial efforts were started in 2006. Despite the long development time, there are no high-volume commercial Li-ion batteries (yet!) in which a silicon anode entirely replaces the graphite one. When it does arrive, the reward will have been worth the wait. We expect automotive cells with NCA or NCM cathodes paired with Si-dominant anodes will increase energy density by up to 50%, thereby dropping the kWh cost by 30-40% in less than a decade.

Another major benefit of a silicon anode that helps break the tradeoffs between energy and power cells is that by storing lithium in a much smaller volume, the thinner Si anodes enable much faster charging. Thinner electrodes allow the lithium ions to reach the anode particles much faster and easier. At the theoretical limit, developing silicon anodes to be 3 times thinner than graphite ones would decrease the diffusion time by up to 9x, creating a very large (not 9x due to limitations on the cathode, but still large) increase in charge speed, thereby breaking one of the major tradeoffs between Energy and Power cells.

The reason for such dramatic improvement is simple - a single Si atom can effectively store four lithium atoms; whereas to store the same four lithium atoms you would need twenty-four carbon atoms in graphite anodes. As a result, Si anodes offer up to 10 times higher capacity per gram (mAh/g), and up to 3 times volumetric capacity measured as (mAh/cc) (Fig. 8).¹¹ We will stretch the auditorium analogy even further here. Imagine that in the silicon anode auditorium, what used to be individual seats in the graphite auditorium have now been replaced by ten stacked seats in the same spots where there was one each before. When the doors open, ten times more people run in to fill the seats. They un-stack them and try to fit into the same auditorium, but because there's not enough space, the people spill out as well.

In more technical terms, the major challenge with silicon is that it expands 3X when it reacts with the lithium during charging, and contracts 3X again during discharging. By contrast, graphite expands about 7% in charge and contracts 7% in discharge. This swelling causes all of the issues that have prevented silicon from replacing graphite. Specifically, large particles of silicon pulverize during these expansions, so many companies have developed "nano silicon" materials that don't build up enough stress to break. However, nano sized particles don't solve the much bigger issue - the damage that occurs to the surface of the silicon, which normally has a passivating film called the solid electrolyte interphase (SEI) which prevents unwanted side reactions. When that damage occurs in the SEI, unwanted side reactions trap the lithium atoms, degrading the capacity very quickly.

	Graphite	Silicon
Chemical Reaction	$C_6 \leftrightarrow LiC_6$	$Si_4 \leftrightarrow Li_{15}Si_4$
Atomic Ratio	1:6	3.75:1 (23x better)
Gravimetric Capacity	372 mAh/g	3,579 mAh/g
Volumetric Capacity	~700 mAh/cc	~2,100 mAh/cc
Swelling During Charge	7%	300%

Figure 8. Comparison table of graphite and silicon anode fundamentals. Despite dramatically better performance, the commercialization of silicon to date has been held back by technical challenges caused by swelling.

⁹ C.S. Fuller and J.A. Ditzenberger "Diffusion of Lithium Into Germanium and Silicon" Physical Review, 91 (1), p. 193, 1953 (DOI: 10.1103/PhysRev.91.193);

¹⁰ A. J. Pietruszkiewicz "Solubility of Lithium in Doped and Undoped Silicon, Evidence for Compound Formation" Journal of Chemical Physics, 25 (4) pp 650-655, 1956 (DOI: 10.1063/1.1743021)

¹¹ X.X. Zuo, J. Zhu, P. Muller-Buschbaum, Y.J. Cheng, "Silicon Based Lithium-ion Battery Anodes: A Chronicle Perspective Review" Nano Energy 31, p. 113-143, 2017 (DOI: 10.1016/j.nanoen.2016.11.013); N. Nitta, G. Yushin "High-Capacity Anode Materials for Lithium- Ion Batteries: Choice of Elements and Structures for Active Particles" Particle & Particle Systems Characterization 31(3), p. 317-336, 2014 (DOI:10.1002/ppsc.201300231)

To overcome this challenge, cell makers mix in very little silicon, less than 10% into a graphite anode, and typically closer to 3-5%. It boosts energy density a bit, but adding more silicon would destroy the cycle life for any practical applications. Pure nano silicon anodes typically can't achieve more than ~100 full charge discharge cycles without playing tricks that cannot be replicated cost effectively at scale.

What's required to replace graphite entirely is a material that compensates for the swelling of silicon through the design of an engineered particle structure. If you can create a particle that allows the swelling and contraction of silicon to happen inside the particle, while keeping the electrolyte outside of the particle, you could cycle the material reversibly 1,000's of times and perhaps 10,000 times without the unwanted side reaction. To be clear, this type of material is exactly what Sila has developed and is scaling and deploying today. It's unlikely Sila has found the only way to achieve this effect, but it appears that all basic nano silicon approaches are stuck and won't reach the market. To bring the analogy back, building an engineered silicon anode material is like building a multi level auditorium that lets you start with the chairs unstacked - it's a lot more reliable of a design.

While developing such a particle is challenging (~10 years if we include early invention at the university in Sila's case, and 40,000 material synthesis iterations), scaling up manufacturing to automotive scale, and at the required cost is even harder. Given that there's never been a need for such a material in the past, entirely new chemical processing techniques are required to synthesize the structure, making it a challenge to do for established chemical manufacturers. Additionally, the process must be done in bulk, as any planar processing (e.g. how solar cells are made) would be 10-100X too expensive at scale. Finally, all input materials have to be existing global commodities - to avoid ending up with massive supply shortages.

It is worth noting that about 1% of the anode materials produced globally today are silicon. That silicon is used as a small additive to graphite based cells as described above. The most prominent example is the Panasonic 2170 cell that Tesla has used since 2015, and there are a few others. The Panasonic/Tesla cell contains about 5% silicon in the form of silicon oxide blended into its graphite anode. This gives a very small boost in energy. The technology, however, has nearly reached its limits and a new type of product, like Sila's silicon, will be required to make the jump to a graphite-free anode.

This isn't to say that an engineered silicon material that can replace graphite has to do that in one step. From a commercialization standpoint, there are big advantages to blending the material with graphite to optimize the cell performance, deploy faster, and be a smoother path to market, blending 25% of the capacity, then 50%, then 100% in successive generations. The key though, is to start with a technology that can get to 100%. Working with materials that will reach their limits at 10% devotes tremendous resources without a long term strategy.

Advanced Cathode - Fluorides. Most commercial work today on cathodes is focused on reducing the cobalt content and increasing the nickel content of the NCA and NCM chemistries. This can increase cell level energy density by ~5% while reducing costs by a few percent more by reducing the dependence on cobalt. However, these improvements will not be transformational. For a transformational improvement, cathode technology also needs to move from intercalation type materials including LFP, NCA, and NCM to conversion type materials (Fig. 9).

The successful transition from intercalation-type graphite anodes to conversion-type silicon anodes will also enable a transition from intercalation-type cathodes to conversion-type cathodes to further increase cell energy density and reduce cost per kWh. The reason a silicon anode is needed first has to do with the balance of the cell - today, any major improvements in the cathode are limited by the mediocrity of the anode. Once the anode becomes 2-3X better, the cathode will be the relatively mediocre partner and in need of an upgrade. Pairing the two novel technologies together will enable batteries with energy densities as high as 1400 Wh/L.

The two main conversion-type active cathode materials that will likely dominate the market are (i) metal fluoride-based cathodes (such as iron fluoride or copper fluoride) and (ii) sulfur-based cathodes.¹² We estimate that this transition, paired with the silicon anode, will be the key to reduce automotive Li-ion cell prices down to ~\$50/kWh by 2030 and ~\$30/kWh by 2040. Also, because high-capacity conversion-type cathodes are not exposed to high voltages (like NCA and NCM cathodes are), electrolyte oxidation and the resulting generation of gases and acids that degrade Li-ion cells can be avoided in such systems. As a result, longer cycle and calendar life can be attained with the right material design and production process that prevents the dissolution of the conversion-type active material. It's plausible that with a conversion cathode and an engineered low-swell silicon anode, the cycle life of Li-ion can be extended all the way to 10,000 full cycles while also having the highest energy density in the market - thus breaking the Power vs Energy Cell compromise.

Advanced Ceramic Separators & Better Electrolytes. We also expect smaller but critical innovation will come from electrolyte and separator developments. Electrolytes used in commercial Li-ion cells degrade by reacting and decomposing on the electrode surface. However, upon decomposition they form surface layers - a so-called solid electrolyte interphase (SEI) on the anode and a cathode electrolyte interphase (CEI) on the cathode - that reduce the reactivity on these surfaces (a process known as “passivation”) and slow down further electrolyte degradation. In the future, electrolytes will become more resistant to degradation and form even more stable SEI and CEI passivation layers, contributing to improved cell stability and safety. Electrolytes will not move to true solid state in the majority of the market within the next decade - see the Bonus section at the end to find out why.

Additionally, porous polymer separators will be replaced by ceramic and ceramic-dominant separators that will offer dramatically improved thermal stability, compression strength and ionic conductance, thus enabling safer, more powerful and faster charging batteries.¹³ We will use our auditorium analogy one last time here. In the analogy, the separator is the hallway that people cross from one auditorium to the other. Today's polymer separators are like a hallway that has 4ft diameter columns spaced 2 feet apart, placed all throughout a very long hall. As people rush from one side to the other, they constantly have to squeeze

Intercalation Materials Examples

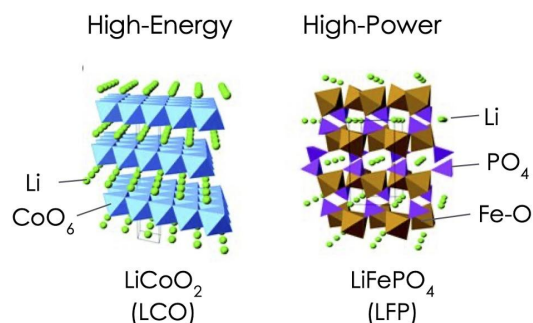

Conversion Materials Example

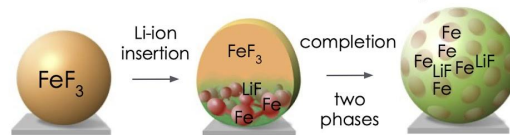

Figure 9. Intercalation materials use a stable crystal structure host that lithium atoms can easily enter and leave without changing or damaging the host. Conversion materials transform the host material's atomic structure during the reaction, making it more challenging to stabilize and reverse the process without side effects.

¹² N. Nitta, F. Wu, J. Lee and G. Yushin, “Lithium Battery Materials: Present and Future”, *Materials Today*, 18(5), p.252-264, 2015 (DOI: 10.1016/j.mattod.2014.10.040); F. Wu and G. Yushin, “Conversion Cathodes for Rechargeable Lithium and Lithium-Ion Batteries”, *Energy & Environmental Science*, 10(2), p. 435-459, 2017 (DOI:10.1039/C6EE02326F).

¹³ D. Lei, J. Benson, A. Magasinski, G. Berdichevsky, G. Yushin “Transformation of Bulk Alloys to Oxide Nanowires” *Science* 355 (6322), pp. 267-271, 2017 (DOI: 10.1126/science.aal2239)

through the small openings between the huge columns. A ceramic separator however can open up most of the space - changing the hallways to using small 1ft columns, spaced 6 feet apart - and also shrinking the length of the hallway to make the transition much faster.

Scaling Performance Materials Through the Consumer Electronics Market. A critical element of innovation, often overlooked by technologists, is how to bring a new technology to market. For Li-ion, the consumer electronics market presents an excellent, and likely necessary path for any new technology.

The best way to tell if a battery technology can work in an automotive sector, is to see it work in the consumer sector first. We saw this in the Basic Li-ion technology which got its start in laptops and cell phones before going into an EV. We saw this with LFP technology which got its start in power tools before becoming a standard in hybrids and some plug-in cars. We also see this in smaller innovations, like safer separators, which were also developed to prevent incidents of laptops catching fire in the early 2000's.

This market entry opportunity is mostly true of material innovations that improve performance (not only reduce cost), since improved battery performance carries such a premium in the devices we use every day. There is a corollary that comes with this line of reasoning - new innovations that claim to dramatically improve performance but don't find their way into any consumer device may still be more of a lab experiment than a commercially ready technology.

Batteries take up nearly half the space of most laptops and phones. A 50% better battery could make for a more beautiful product, or create space for new and better features like 5G, improved cameras, stronger sound, or even mini projectors. Of course, as the Li-ion cell was a key enabler of small mobile phones, newer batteries will also be a key enabler of even smaller devices we will wear rather than carry. And not unlike buying an early EV helped propel R&D for lower cost EVs, buying a phone with an advanced battery will help propel R&D for accelerating the EV revolution.

Summary of Upcoming Materials Innovation. The biggest leverage will come from these components, which make up nearly all of an assembled Li-ion battery, yielding dramatic performance improvements. When the materials that you build the battery from are much higher performance, the battery itself quickly becomes higher performance - regardless of the manufacturing process or scale you're working with, or the market you're addressing. In addition to these material improvements, however, we also envision major improvements in how the battery is built which we discuss in the next section. The manufacturing improvements can be highly synergistic with the components improvements we just covered and lead to an even more accelerated decline in cost and increase in performance.

The Opportunities - Li-ion Manufacturing Improvements

The Manufacturing Basics. There are three major contributions to cell manufacturing costs excluding components (materials), R&D costs, sales costs, and profits: (i) production of electrodes (~40%), (ii) cell assembling (~20%) and (iii) cell finishing (~40%). We expect to see major innovations in each of these and we break them out below.

Today's electrodes are produced by mixing active materials (the anode particles or the cathode particles) with a few percent conductive additives, a bit of polymer binders, and a liquid solvent such as water to create a

slurry.¹⁴ This slurry is then cast on metal foil current collectors (anodes on copper, cathodes on aluminum) in about a 0.2-0.4 mm layer. It's then slowly dried to remove the liquid solvent, after which it's pressed in order to densify the coating to about 0.06-0.09 mm thickness (half the thickness of a human hair), and eventually vacuum-dried to remove any residual water molecules on the surface.

The electrodes are then cut and stacked (or rolled) together in a sequence of (anode electrode, separator, cathode electrode, separator), (anode electrode, separator, cathode electrode, separator), etc. From our analogy, each repeating stack is the pair of auditoriums with a hallway in between. For a typical cell phone battery, there might be 20-30 repeating stacks. For a thicker automotive battery, there may be 100 repeating stacks. Although stacking is the easiest way to visualize this, the same effect can be achieved by winding a single long pair of electrodes into a cylindrical form.

This stacked (or wound) set of electrodes and separators is then placed inside of the case (either an aluminum hard case or pouch soft case) and filled with electrolyte. The cell then undergoes an initial charge-discharge cycle to “form” the battery. This first charge-discharge “formation” step results in a lot of one-time side reactions that “passivate” the battery electrodes which will keep them stable (i.e. passive) from then on during cycling. Once this formation is finished, the side-reaction gasses are evacuated and the cells are permanently sealed. Finally, the cells undergo lengthy aging and quality control tests before being shipped for pack assembly. This is a long process (Fig. 10)!

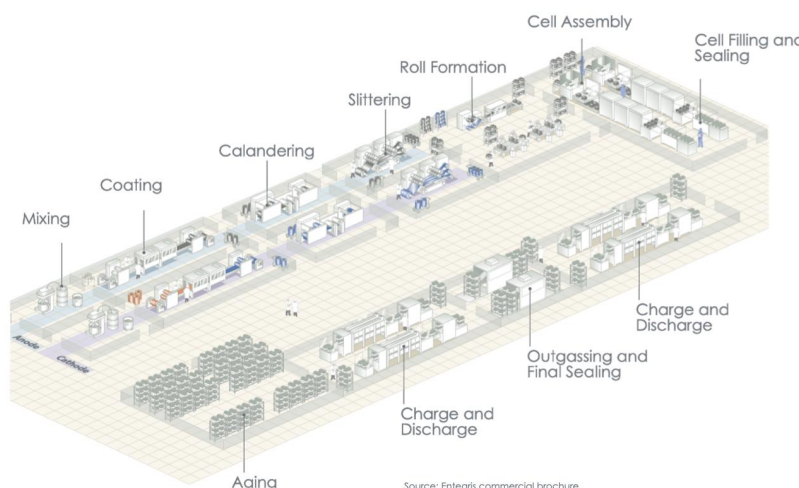

Figure 10. A typical Li-ion factory process flow. The process starts at Mixing, moves around the factory and ends at Aging.

Advanced Electrode Production.

In the coming decade, three major improvements in electrode production will take place. First, the industry will replace all toxic organic solvents used in electrode casting with either dry electrode processing (no solvents) or fast-drying of water-based processing (anode production already uses water). This will reduce the costs of the drying machines, which today are required to capture the toxic organic solvents so they can be recycled. With water, the expensive capture and recycling componentry can be eliminated (without harming the environment).

Second, we expect electrode designs to become more sophisticated. Today, electrodes are made from randomly sized, randomly oriented, and relatively poorly packed active materials - which creates long and indirect paths through the electrolyte for the lithium ions to travel. In materials science these paths are described as "tortuous". These tortuous paths are akin to not having rows of seats in the auditorium, just randomly distributed clusters of seats. Today's electrodes also use an excessive amounts of inactive materials, both polymer binders and conductive additives, because it is difficult to distribute those inactive materials to only where they're needed in the electrode - the points where particles touch one another.

¹⁴ D. Wood, J.L. Li, C. Daniel, "Prospects for Reducing the Processing Cost of Lithium ion Batteries" Journal of Power Sources 275, p. 234-242, 2015 (DOI:10.1016/j.jpowsour.2014.11.019)

In the future, electrodes will be much more engineered with dramatically reduced tortuosity for faster ion transport because they will use lower amounts of precisely distributed inactive materials (through novel processing techniques). This will enable greater thickness and densification of more uniform and more ordered active material particles, which will reduce the number of repeating stacks needed in a cell, speeding up and reducing the cost of the manufacturing process.

Lastly, better binders with greater strength and adhesion will ensure electrode integrity while reducing binder content. These stronger binders can also lead to lower swelling of the electrodes, minimize undesirable reactions between electrolyte and active materials at the binder/particle interface, and lower resistance.^{15,16} Overall, better binders can play a huge role in expanding the design space of the electrode, which in turn can improve performance and reduce the cost.

Advanced Cell Assembly. Improvements in cell assembly will come from combining multiple components. For example, the separator can and likely will be integrated into the top surface of an anode instead of being a standalone layer between an anode and a cathode. Handling of standalone separators today is incredibly hard. They are now as thin as 8µm (micron), hard to pick up with suction due to their porosity, hard to hold in place for precision assembly due to high non-conductivity and frequent movement from static charges, and are sensitive to minor defects that can cause catastrophic failure of the battery including fire. A much better approach will be to integrate a layer of non-conductive separator material directly onto the electrode before the stacking or winding process.

We also expect that more uniform electrodes with improved mechanical properties and adhesion to the current collector could be stacked or rolled at a significantly faster speed. Advanced sensors and in-line diagnostics will similarly maximize cell assembly rates without sacrificing quality. Development of fast laser cutting will eventually replace mechanical electrode slitting as it offers better edge qualities and can eliminate debris that induce shorts and reduce cell production yield.

Advanced Cell Finishing. Three key improvements in cell finishing are also expected. First, the use of ceramic separators and less tortuous electrodes will greatly accelerate electrolyte filling into dry cells. Today's polymer separators are poor at wicking electrolyte into the cell and are also only about 40% porous. Ceramic separators can reach porosities up to 80% and have excellent electrolyte wicking properties, both improving charge performance and speeding up the manufacturing process.

Second, novel charging algorithms using optimized pulsed or alternating current charging¹⁷ can accelerate formation and increase the quality of the passivation of the electrodes, improving cycle life and speeding up manufacturing. Finally, improved precision of cell diagnostics will minimize the length of aging and quality control steps. For example, the use of more precise electronic equipment in combination with novel diagnostic techniques - for example the use of ultrasound¹⁸ - would be able to detect undesirable irregularities in cell behavior much faster than today's processes and improve quality yield, thus lowering overall costs.

¹⁵ D. Bresser, D. Buchholz, A. Moretti, A. Varzi and S. Passerini "Alternative Binders for Sustainable Electrochemical Energy Storage – the Transition to Aqueous Electrode Processing and Bio-Derived Polymers" *Energy Environ. Sci.*, 11, pp.3096-3127, 2018 (DOI:10.1039/C8EE00640G)

¹⁶ A. Magasinski, B. Zdyrko, I. Kovalenko, B. Hertzberg, R. Burtovyy, C.F. Huebner, T.F. Fuller, I. Luzinov, G. Yushin "Toward Efficient Binders for Li-ion Battery Si-Based Anodes: Polyacrylic Acid" *ACS Appl Mater Interfaces*, 2(11), 3004-10, 2010 (DOI: 10.1021/am100871y)

¹⁷ S.Q. Zhu, C. Hu, Y. Xu, Y. Jin, J.L. Shui, "Performance Improvement of Lithium-ion Battery by Pulse Current" *Journal of Energy Chemistry* 46, p. 208-214, 2020 (DOI:10.1016/j.jechem.2019.11.007); X.R.Huang, Y.Y. Li, A.B. Acharya, X. Sui, J.H. Meng, R. Teodorescu, D.I. Stroe, "A Review of Pulsed Current Technique for Lithium-ion Batteries" 13(10) A2458, 2020 (DOI: 10.3390/en13102458)

¹⁸ C. Bommier, W. Chang, J.L. Li, S. Biswas, G. Davies, J. Nanda, D. Steingart, "Operando Acoustic Monitoring of SEI Formation and Long-Term Cycling in NMC/SiGr Composite Pouch Cells" *Journal of the Electrochemical Society*, 167(2) A. 020517 2020 (DOI: 10.1149/1945-7111/ab68d6)

Integrated Cell, Module, and Pack Design. There are some innovations that may only be available to OEMs who decide to take on cell manufacturing in house, as VW and Tesla appear to be doing or cell makers who look to go closer to vehicle chassis design as CATL is attempting to do. If the cell is manufactured in the same factory as the module and pack, and isn't sold as a component, it is possible to integrate the manufacturing processes for cell, pack, and car together and customize the cell design even further to fit the proprietary module (Fig. 11).

In customizing the designs, the cell shape could be designed to connect directly into the module and create an ideal connection to the cooling systems, eliminating the need to design the module and cooling around a pre-existing cell. Going further, the cell casing could be designed to be the base structure of the module - essentially building the electrodes into the module directly rather than building cells that assemble to become a module. Cells could also be customized in height for each vehicle - larger vehicles would use taller cells (which are vertically aligned under an EV's floorboard) to accommodate the larger battery capacity needs of SUVs without altering the pack platform design. For example, a sedan and an SUV would have identical pack layouts and architectures, but one would use a 20% taller cell. This would be difficult for a standalone cell maker with many many auto OEM customers to do, since each OEM would have their own module technology.

Integration of the manufacturing processes from cell to car allows aging of the cells to be done while they are being assembled into the modules, into the pack, or vehicle. That means you can store less cells in inventory while they age, saving costs. If defective cells are identified after module integration (one of the benefits of aging a cell is to find failures), in a fault tolerant module design that cell could be disconnected, replaced, removed, if the module was designed with fault tolerance in mind.

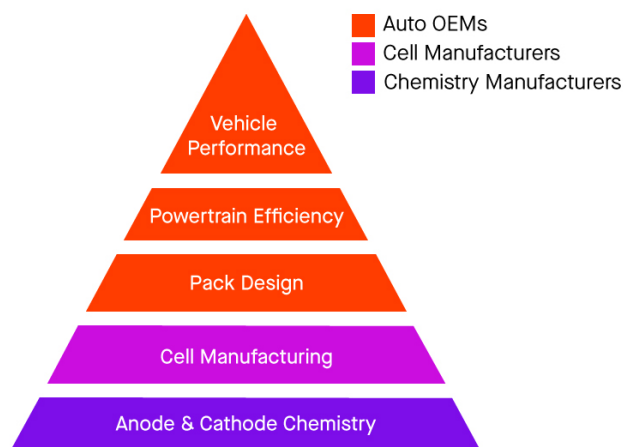

Figure 11. Making a best in class vehicle requires best in class technology in the entire stack from the chemistry, to the cell manufacturing, to pack and powertrain design. Substandard performance at any layer will negate any benefits from the other technology layers and result in higher vehicle costs.

Summary of Manufacturing Innovation. Although the lithium ion cell manufacturing process has been extremely well refined over the last thirty years, there continue to be good opportunities to simplify it, increase performance, and speed it up to lower costs. While these improvements won't be nearly as impactful as the improvements of the material components, since the manufacturing improvements are complementary the combined impact can be transformative.

The Scale

In considering the future of energy storage, it's important to consider the scale of Li-ion technology today, and the scale that will be needed in the future. Technologies that claim they will replace Li-ion often grab headlines, but scale limitations make that impractical within a generation. It is for this reason that by 2050, while Li-ion will not constitute all of energy storage, it will be the most dominant chemistry by far with most everything else relegated to niche applications. These niche applications will be multi-billion dollar markets in scale, but still niche when considering the trillion dollar scale of the storage market overall.

Before Tesla was founded, Li-ion batteries were almost exclusively used in consumer electronics - mainly laptops and cell phones. At the time of the launch of the Tesla Roadster in 2008, the total global Li-ion

manufacturing capacity was approximately 20 GWh per year. By 2030, we expect over 2,000 GWh of annual production capacity based on already announced plans by cell manufacturers.¹⁹

If we assume that the price will reach the predicted \$50/kWh for cells, the market will amount to \$100B annually in 2030 at the cell level (while packs and systems increase the market by 25-50%).

This more than 50X increase in production scale from the start of the EV revolution to 2030 will be unprecedented and any technology looking to replace Li-ion will need to have a clear plan of how it would compete with an incumbent of this size when it first arrives on the scene - it won't be easy.

Looking beyond 2030, we will need about 10,000 GWh to transform all light duty transportation, and a similar amount to support truck, bus, and other medium and heavy duty transport by the middle of the century. Add in daily use grid storage requirements for moving to 100% renewables, along with global development and increased demand for electricity and transportation, and it's plausible that the global need for Li-ion storage will reach 30,000 GWh by mid century with a market scale of \$1T+ per year. If we're fortunate enough to see energy storage reach this scale, we will have transformed the economy - both electricity and transportation - from a carbon intensive fuel source to a sustainable 100% renewables base. To achieve this future, we must focus not only on innovation, but on innovation at massive scales.

To reach this 30,000 GWh of capacity using today's components, we can calculate the needs of each component by weight per year:

- With graphite anodes, we would need about 23 million tons of graphite annually to support this capacity
- With silicon anodes, however, you would need 5-10X less (2-4 million tons of silicon annually) due to the dramatically higher capacity per kilogram of silicon compared to graphite
- With NCA or NCM cathodes, assuming 90% nickel and 5% cobalt, the industry would require 1.2 million tons of cobalt and 22 million tons of nickel
- These numbers are very large and should cause us to commit to a path that can achieve this scale with the environment and sustainability in mind today, using re-use wherever we can and recycling where that's not possible. For reference we should also keep in mind that we extract roughly 12 million tons of oil, 21 million tons of coal, and 7 million tons of natural gas from the **earth every single day** while the battery materials numbers here are on an annual basis

While the graphite and silicon numbers present no real challenge from a global resource scarcity standpoint, the cobalt and nickel scale will become a challenge. Currently, the world produces 150 thousand tons of cobalt and 2.5 million tons of nickel per year for multiple applications in different industries which also are experiencing growth (magnets, superalloys, steels, aerospace, etc.). The total commercially viable world reserves are limited to 1.5 million tons for high-grade (relatively inexpensive to mine) cobalt and 36 million tons for Class-1 (battery grade) nickel. Based on projected demand growth a significant shortage of these metals and a resulting substantial price increase may take place in as little as 10 years.²⁰

¹⁹ <https://www.benchmarkminerals.com/benchmarks-megafactory-tracker-exceeds-2-terawatt-hours-as-solid-state-makes-its-first-appearance/>

²⁰ K. Turcheniuk, D. Bondarev, G. G. Amatucci, G. Yushin, "Battery Materials for Low-Cost Electric Transportation", Materials Today (in review, 2020)

Scaling first to 2,000 GWh by 2030 and then to 30,000 GWh by 2050 will also require a massive amount of capital investment. Today, automotive scale Li-ion production plants are built by only a few companies globally - most prominently CATL, LG, Panasonic, Samsung SDI, SK, and the newest entrants, Farasis and Northvolt (several other companies have been formed to enter this space, but have not made major progress yet). Based on industry announcements, Li-ion manufacturing plants cost between \$50M and \$100M for each GWh of annual production capacity.

With these estimates, we can project that additional capital investments totaling between \$75B and \$150B will be required between 2020 and 2030 to expand to the projected 2,000 GWh of capacity (some of this has already been invested pre-2020). Similarly, if the cost of manufacturing facilities doesn't decline, we may require as much as \$3T invested by 2050. This is at the upper end of the estimate, and not likely to be accurate for a couple of reasons.

First, every materials improvement we described reduces the \$/GWh plant costs proportionally to the increase in energy density it produces. For example, if a new anode and cathode double the energy of each battery coming out of the factory, then the GWh capacity of the plant doubles with zero additional investment in the factory. That means the \$/GWh capital requirement of the factory is reduced in half simply by the chemistry upgrades.

Second, the manufacturing innovations described earlier will play a major role in reducing the costs of manufacturing by speeding up the process. As the process speeds up, the same factory produces more cells, and more GWhs of capacity annually. While it is hard to estimate the total improvements accurately, we believe it would be reasonable to assume at least a 2X improvement from today's low end by 2030, with new plants built from 2030 onward costing <\$25M/GWh - and additionally dropping costs due to the learnings from each new factory built. At such costs, the massive scaling phase from 2030 to 2050 could cost less than \$750B rather than several trillion, further accelerating the transition (Fig. 12).

Car Makers, Battery Makers, and Vertical Integration. As it becomes apparent to all conventional automotive OEMs that all passenger vehicles will go electric in the coming decades, a major balance of power transition is occurring where vehicle makers are suddenly finding themselves dependent on their supply base, specifically battery cell makers. This is not a position auto OEMs are used to, having established robust supply chains in conventional internal combustion engines over the last century.

Unlike engine and mechanical chassis components, the number of Li-ion providers capable of providing Li-ion cells at automotive scale, quality, and costs is miniscule - just the 6-7 today listed before. The rapid change in demand is also causing major challenges whereby cell suppliers will not build the factories without firm commitments, but auto makers are hesitant to commit without knowing what demand will look like several years from now. When demand for EVs exceeds cell supply, OEMs are left with inadequate supply and higher cell prices.



Figure 12. Li-ion factories around the world from clockwise from top left: Tesla's 35 GWh factory in Nevada; CATL's HQ and 45 GWh factory in Ningde, China; SK's 10 GWh factory in Georgia; rendering of Northvolt's 16 GWh facility under construction.

The result is that we've seen the biggest EV manufacturers move to have tighter control of their supply chain through partial vertical integration. Initially, Nissan produced their own Li-ion cells for the Nissan Leaf, (although sold the plant after a decade due to a wavering commitment to EVs). Tesla formed one of the closest partnerships in the business with Panasonic - co-building and operating the Gigafactory. VW has made huge investments in Northvolt and is establishing a JV plant with the company. Panasonic and Toyota are also heading in that direction, announcing a JV and committing thousands of engineers to the effort. Finally, although still only rumors, it's likely that Tesla will soon announce battery production plans entirely of their own. Other avenues for expanded control includes the auto makers signing deals for the raw materials - graphite, nickel, lithium, etc. - to ensure that regardless of who their battery supplier will be, they can provide the inputs that the battery maker will need.

There are several reasons these partnerships and vertical integration initiatives are extremely advantageous at this time. The rapid and coordinated decision making in a young but extremely fast growing industry can create a virtuous cycle - accurately planning demand and controlling the costs of the necessary battery supply. Additionally, since the core Li-ion manufacturing process has been developed over 30 years in the consumer industry, the major cell makers have institutional knowledge that is essential for success - knowledge that the auto OEMs need to acquire if they are to vertically integrate. It remains to be seen if this will be required as the industry matures beyond 2030.

The institutional knowledge of the incumbent battery makers also forms a barrier to for new entrants in cell manufacturing. Northvolt, the newest auto-focused cell maker seems to be off to a good start, by hiring experts with battery cell manufacturing knowledge from the existing global manufacturers, and securing low-cost renewable electricity and local access to nickel. They also have major structural advantages for supplying the European market and contracts with BMW and VW, but the results will only be visible in another 5+ years. Farasis, another ambitious player, started with an existing battery team and has partnered with Daimler. But the key engineers needed are a scarce resource right now in the world and it will get harder to get a critical amount of talent.

The third reason is that the OEMs have usage data that is very helpful for the cell manufacturers in designing their cells specific to the vehicle application. They are also able to collaboratively design the cell for a specific module, which allows the cell, pack, and vehicle to be better optimized for safety, performance and cost.

Impact on Transportation and The Grid

The innovation coming in the next decade, moving from conventional Li-ion to advanced Li-ion cells, will have a major accelerating effect on the electrification of all ground transportation. We've already seen a growth in global EV sales in the 30-50% per year range since 2011 - and we expect to see this incredible growth continue. With 2,000 GWh of capacity in 2030, the world will be buying 20-30M plug-in cars (depending on pack sizes). It will take longer to get 100% of new vehicles to be electric, and then another decade to replace the gas engine cars already in circulation, so it's practically unlikely we have 100% EVs on the road until mid-century.

There are two other transportation trends that will converge to accelerate the shift to EVs. The first trend is the major expansion of on-demand ride hailing - Uber, Lyft, and others - which are increasing the number of miles driven on those vehicles. While a typical car owner might drive 12,000 miles a year, an on-demand driver can drive 50,000 miles a year. This shifts the total cost of ownership to the variable costs (maintenance and fuel) rather than the fixed costs (vehicle depreciation). This is where EVs shine - the per mile costs, for an EV charged at night on an appropriate EV rate is ~2.5¢/mi. In contrast, a sedan with 25mpg rating, and \$3/gallon (€0.66/liter)

cost of gas amounts to a 12¢/mi, ~5X higher cost to operate. Both of those numbers may seem low, but the difference amounts to \$5,000 in savings every year for a full time driver - \$50,000 over the life of the car. Additionally, EVs require far less maintenance. The key of course is making the upfront cost of the EV low enough to compete with a typical gasoline sedan.

This major cost advantage EVs have over gasoline cars when used heavily becomes even bigger as transportation moves to autonomous. It's easy to imagine an on-demand autonomous vehicle (AV) driving, on average, two or three times the miles a human driver would (some will drive 24hrs a day, but demand fluctuates, so there are many periods where some AVs will be parked). This 2-3X increase in miles would translate to an even bigger \$100-\$150k in savings over a 10 years life of the autonomous car. To make this possible, the innovations we discussed above which enable a 1M+ mile battery would also have to be achieved first. A similar analysis can be extended to medium and heavy duty trucking vehicles, making it clear where the sudden interest in this topic from companies like Amazon and Walmart is coming from.

While we focus nearly exclusively on ground transportation in our analysis, it's worth noting that there will also be meaningful opportunities for electrification of sea and air travel, although in much smaller niches than for ground transportation. Local ferries can and will move towards electrified operation due to the lower operating costs. In air travel, the advent of electric vertical takeoff and landing (e-VTOL) systems for local transportation will not only replace conventional helicopters, but even start to expand the size of the market lowering the operating costs and an intrinsically safer design that a multi-motor system with a redundant electrical system can provide when the vehicle is battery powered.

On the grid, the expected impact is clear - the 2030 vision for the advanced Li-ion battery we lay out here would enable 100% renewables by solving the majority of the intermittency problem. A battery cell capable of 10,000 cycles and 30 years life, with an up front cost of \$50/kWh would pair with every solar and wind installation. This would make the diurnal and perhaps several day intermittency a non-issue. There would still be a need to ensure renewables, on very rare occasions, don't cause intermittency on a weekly basis, for which perhaps a different, long duration energy storage chemistry will be appropriate. However, Li-ion will still constitute the majority of the storage on the grid as the daily needs are far greater.

Conclusion

The future of energy storage, advanced Li-ion batteries, and electric vehicles is incredibly bright. There are tremendous opportunities for innovation in the chemistry and materials space to make substantially better Li-ion components that can drop into existing factories and the many factories being built around the world in the next decade. The reality of a Li-ion battery capable of simultaneously delivering \$50/kWh costs, fast charging, 10,000+ cycles, 1M+ miles, a 30-year calendar life, all while being made with abundant raw materials found all around the world and recycled is within reach in the next 10 years. The demand for such a battery would reach unprecedented levels, as high as 30,000 GWh annually by mid century, as the world transforms from a fossil fuel based economy to an entirely solar and wind powered one.

Now let's get back in the labs & factories, and build!

Bonus: The False Hope of Solid State or Lithium Metal

There has been a lot of discussion in the press about solid state batteries in the last few years with investments totalling in the hundreds of millions of dollars across more than a dozen start-ups. While there are technical reasons why this technology appears to be the holy grail of batteries, the reality is that even if the technology works (and that is a big "if" after 40 years of development) the technology is unlikely to find more than niche opportunities in the market.

Reasons for the Dream. Calling the technology “solid state” doesn’t tell the real story - the reason to use “solid state”, refers to replacing the electrolyte which in conventional Li-ion is a liquid, with a solid. The reason to do this is to enable the use of a lithium metal anode that would replace the graphite anode entirely. A better name would be “lithium metal anode” technology, which has a long ~40 year history of major technical and commercial challenges pre-dating conventional Li-ion.

Using pure lithium metal has the appeal that it can store lithium dramatically denser than lithium can be stored in graphite, increasing cell energy density. Pure lithium metal has volumetric capacity of 2062 mAh/cc, which is much higher than lithium in graphite rated at up to 600-630 mAh/cc (at the material level after full lithiation). Moving from graphite to pure lithium could create ~50% energy density improvement leading to substantially lower \$/kWh costs.

The Harsh Technical Reality. There are many technical reasons to doubt that after 40 years of unsuccessful lithium metal anode development, something is fundamentally different this time, other than the “solid state” branding. There is a myriad of technical challenges to overcome, starting with the risk of lithium dendrite plating. Lithium, like other metals, has a property that causes it to attach to high spots rather than in low spots when plating into an electrode film. This leads to the building of lithium spikes (dendrites) on the anode that pierce the separator, short circuit to the cathode, and cause catastrophic thermal runaway (fire) of the battery. Eliminating these dendrites entirely is the biggest fundamental challenge of lithium metal anodes.

The likelihood of lithium metal cell failure depends on the chemical and physical uniformity of the anode substrate (the copper foil), the solid electrolyte, and the deposited Li. Plating lithium metal leads to volume changes in the cell, which in turn generates stresses that lead to failure if these stresses are concentrated on any nonuniformities. Most ceramic or glass/ceramic electrolytes contain small pre-existing defects such as grain boundaries, pores, impurities, inclusions, dislocations, etc., unless very expensive planar vapor deposition techniques are used to make them. Any small variations in (i) the properties of solid electrolytes or (ii) the contact between solid electrolytes and copper substrate or (iii) the properties of copper current collectors lead to low production yield in the best-case scenario where defective cells are identified at factories or more likely, premature failures in the field.

Long cycle life in a few small cells (<0.01 m² electrode surface area) with extremely uniform, amorphous and grain boundary-free solid electrolytes have been demonstrated, because it is statistically possible to make such a small cell without a single defect. Some testing has demonstrated long cycle life on these tiny batteries without dendrite formation, but this is typically done at very low charge rates - far too low for practical EV use. Unfortunately, charging at relevant rates for EVs (4-20 mA/cm²) dramatically accelerates the formation of lithium dendrites and leads to catastrophic failure. Even more challenging is preventing formation of life-threatening defects in an automotive battery with ~500 m² of high areal capacity electrodes subjected to fast charging, where it’ll be statistically impossible to avoid all defects - that is a whole different game. This requires nanometer-precise, semiconductor-grade equipment, and processes that exist only for the fabrication of electronic chips and silicon solar cells, but are orders of magnitude too expensive for batteries. There is no technology on the horizon that could reduce such costs meaningfully. There have been many attempts over the last decade without success²¹ and even if a good defect-free electrolyte is developed, that may not be enough.²²

²¹ K. Kerman, A. Luntz, V. Viswanathan, Y.-M. Chiang, Z. Chen “Review - Practical Challenges Hindering the Development of Solid State Li Ion Batteries” *Journal of The Electrochemical Society*, 164(7) A1731-A1744, 2017 (DOI: 10.1149/2.1571707jes); R. Chen, Q. Li, X. Yu, L. Chen, H. Li “Approaching Practically Accessible Solid-State Batteries: Stability Issues Related to Solid Electrolytes and Interfaces” *Chem. Rev.* 120, p. 6820–6877, 2020 (DOI:10.1021/acs.chemrev.9b00268)

²² R. D. Schmidt and J. Sakamoto, “In-situ, Non-Destructive Acoustic Characterization of Solid State Electrolyte Cells” *Journal of Power Sources*, 324, p. 126, 2016 (DOI: 10.1016/j.jpowsour.2016.05.062)

If those materials and design challenges are overcome then the manufacturing challenges will start to loom large. A key consideration in manufacturing is the packing density of the cathode which is critical to reach high energy density and low cost. When mixing solid electrolytes with cathode particles, getting to a high cathode fraction in the electrode will require high temperatures and pressures in forming the electrodes while keeping the process moisture-free. If this processing is done at lower temperatures and without pressure, a low cathode active fraction will result, making energy density performance much worse and costs higher. Solid electrolyte cells will realistically need to produce electrodes in moisture-containing (e.g., regular air) environment for low production costs, but because of the very high reactivity of lithium metal with water vapor in the air, lithium metal anodes need to be produced in a fully discharged (Li-free) state prior to assembling into cells - vastly limiting the available technology choices. If building a solid state cell in the charged state with lithium metal, it would require a dry-air environment, which is expensive and not compatible with Giga-factories currently being built around the globe.

In addition, solid electrolytes are heavy - (2-4X of liquid electrolytes), and often use toxic, expensive, or rare elements, and are brittle and prone to micro-cracking during processing or under even small stresses which occur during use in a vehicle. This limitation leads to much more stringent requirements for packs that would use these solid state cells - requirements to build major mechanical structures to keep the cells under a constant pressure and very rigidly immobilized.

Harsher Market Reality. As challenging as the technical hurdles are, the market reality will be worse for solid state technologies in the coming decades. As described above, the solid electrolytes are fundamentally incompatible with battery giga-factories being built around the world now. It's unlikely that solid state technology will reach GWh scale in the next decade, and by 2030 there will be 2,000 GWh of production capacity worldwide that it will be incompatible with. If the performance of solid state electrolytes with lithium metal anodes were substantially better, particularly on a \$/kWh basis, new factories would certainly be built - however, a path to that advantage is not clear.

The path to a lower \$/kWh for lithium metal would be through increased energy density - storing more energy without increasing the cost. However, silicon anodes, which are becoming commercial now, are able to reach a similar energy density improvement as the one promised by lithium metal. The theoretical density of pure lithium metal is often cited, and intuitively one would think nothing can store lithium denser than pure lithium - yet silicon actually pulls the lithium atoms closer together than pure lithium, with silicon alloys of $\text{Si}_4\text{Li}_{15}$ at 2190 mAh/cc while pure lithium metal clocks in at 2062 mAh/cc. Building \$100B+ of factories for a new battery technology that has neither the \$/kWh cost advantage, nor the energy density advantage relative to a future silicon anode based cell will not be attractive in the market.

All that being said, for the sake of the EV revolution we would be glad to be wrong about solid state. The world needs better batteries and if enterprising scientists and engineers find ways to overcome these challenges, drive the price to \$50/kWh, and transform the energy sector, we'd gladly cheer on their technical success while competing in the marketplace.

About the Authors

Gene Berdichevsky - Co-Founder & CEO

Gene Berdichevsky is the Co-Founder & CEO of Sila Nanotechnologies. Prior to co-founding Sila, Gene was the seventh employee at Tesla Motors where he served as Principal Engineer on the Roadster battery, leading the development of the world's first, safe, mass-produced, automotive Li-ion battery system.

Gene holds two degrees from Stanford University; an MS in Engineering with a focus on energy and materials, and a BS in Mechanical Engineering. He has co-authored 42 patents and 4 peer-reviewed academic publications. Gene has been named to the Forbes 30 under 30 list, the MIT Technology Review 35 Under 35, and was a recipient of the Paul and Daisy Soros Fellowship for New Americans.

Gleb Yushin - Co-Founder & CTO

Gleb Yushin is the Co-Founder & CTO of Sila Nanotechnologies. He is also a Professor of Materials Science at Georgia Institute of Technology and an Editor-in-Chief for Materials Today. Gleb has co-authored over 110 US and international patents and patent applications and over 160 peer-reviewed academic publications, which have been cited by nearly 30,000 times. For his contributions to the development of energy storage materials Gleb has received numerous awards and was recognized as one of the world's most influential scientific minds by the Electrochemical Society.

His distinguished contributions to the advancement of materials and energy storage research have also been recognized by his election as a Fellow of the Materials Research Society, a Fellow of the Electrochemical Society, a Fellow of the EU Academy of Sciences and a Fellow of the National Academy of Inventors. Gleb holds BS and MS degrees in Physics from Polytechnic Institute and a PhD in Materials Science from North Carolina State University.